



TOP FORM

Catálogo de componentes

Furniture components catalogue



2021-2023



TOP FORM

Y sin darnos cuenta, 50 años de vida

Medio siglo de vida. 50 años de andadura. **Top Form Group cumple 50 años** en el sector de componentes del mueble, sumando experiencia, conocimiento del mercado, innovación, diseño y calidad. Toda una trayectoria encaminada a satisfacer las necesidades de nuestros clientes y ofrecerles un servicio absolutamente profesional.

Durante estos 50 años, siempre hemos intentado ser pioneros en la introducción de nuevos productos y sistemas de fabricación. Tenemos claro que dar la mejor solución a nuestros clientes y partners es nuestra prioridad.

Nuestra especialidad es ayudar a mejorar el mundo de la cocina, la decoración y el mobiliario. Y este catálogo, recoge la que sin duda es una de las mayores ofertas de producto en componentes para el mueble del mercado.

Os presentamos una **gama nueva, moderna y adaptadas a las tendencias del sector**, además de nuevas y funcionales herramientas que pondremos a tu disposición y que mejorarán tu experiencia.

Estamos preparados para ser tu compañero de viaje... esperamos que os guste este vuelo. ¡Gracias por vuestra confianza!

50 years of life

Half a century of life. 50 years of experience. Top Form Group celebrates 50 years in the furniture components sector, adding experience, market knowledge, innovation, design and quality. A whole trajectory aimed at satisfying the needs of our clients and offering them an absolutely professional service.

During these 50 years, we have always tried to be pioneers in the introduction of new products and manufacturing systems. We are clear that giving the best solution to our clients and partners is our priority.

Our specialty is helping to improve the world of kitchen, decoration and furniture. And this catalog includes what is undoubtedly one of the largest product offers in furniture components on the market.

*We present a **new, modern range adapted to the trends of the sector**, as well as new and functional tools that we will put at your disposal and that will improve your experience.*

We are ready to be your travel companion... we hope you like this flight. Thank you for your trust!



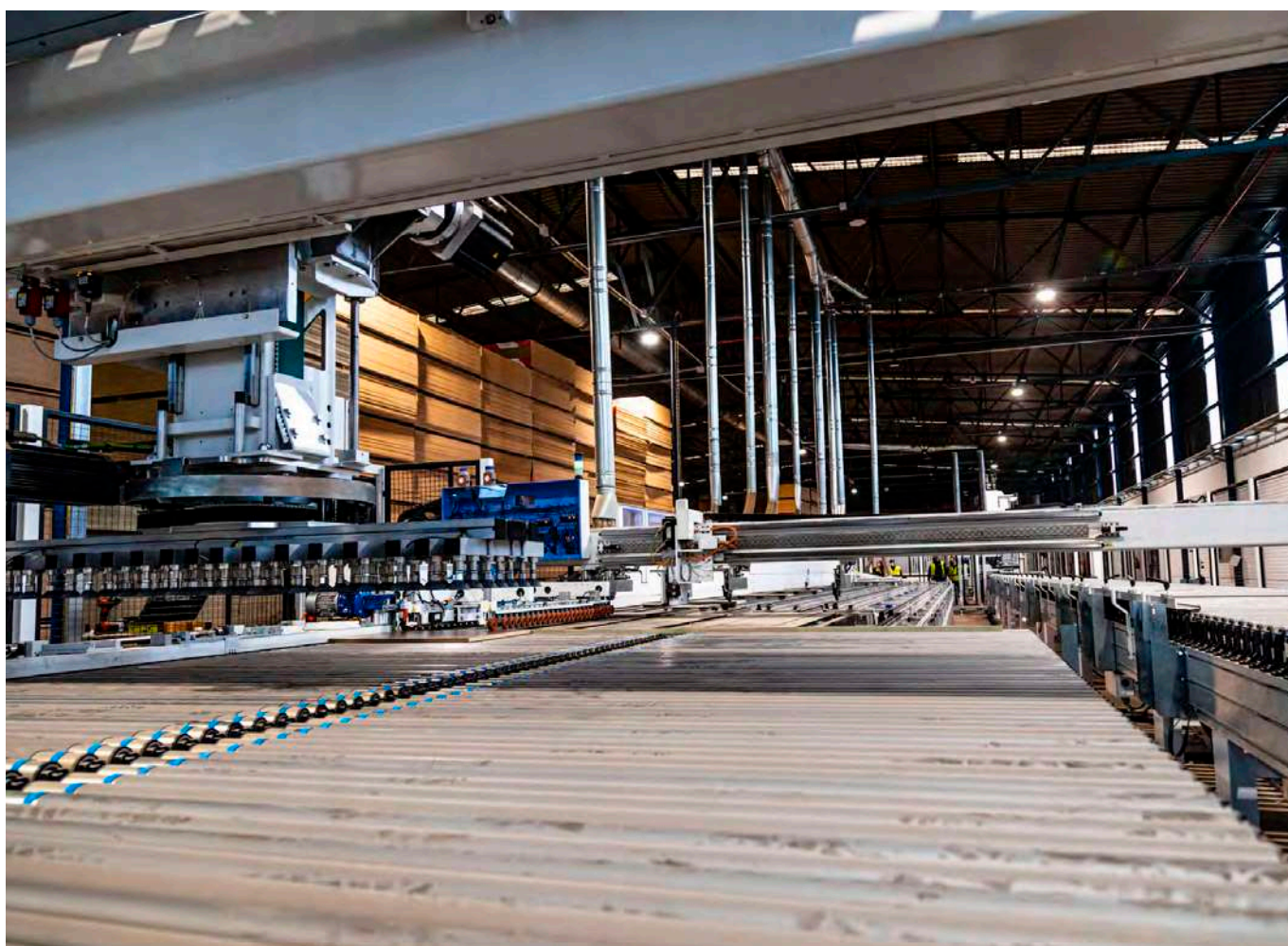

Top Form Group

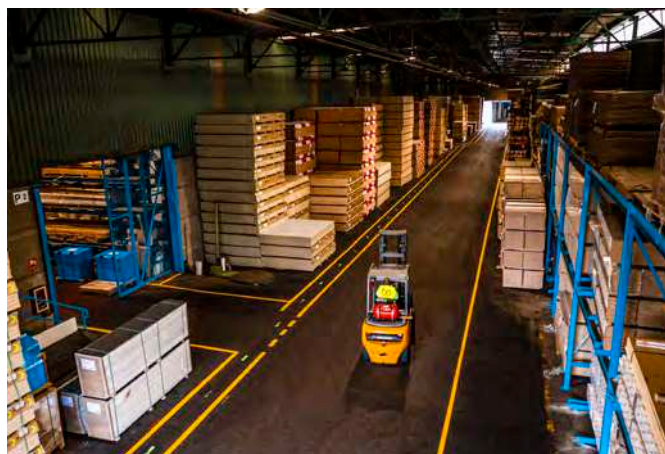

El Grupo Top Form comienza su andadura en el año **1970** concentrando la oferta desde sus inicios en la **fabricación y distribución de componentes para el mueble**, siempre ahondando en el profundo conocimiento de las necesidades de nuestros clientes para ofrecerles la solución más adecuada y en la calidad de nuestros productos.

El Grupo en España, con sede central en **Yuncos (Toledo)**, es uno de los **grupos industriales más importantes del sector del mueble**. Dispone de **4 plantas productivas** ubicadas en la provincias de Madrid y Toledo, concentrando más de **140.000 metros cuadrados**, que operan con los máximos estándares de calidad y medioambientales. Es uno de los pocos grupos del sector que desarrolla el ciclo completo de la producción del componente, desde la materia prima hasta el producto acabado.

Con **11 centros logísticos y de ensamblado de muebles en 3 países diferentes**, consigue estar siempre cerca del usuario final ofreciendo el mejor servicio en sus productos, avalado por sus **50 años de experiencia** dentro del sector.

Más de **400 personas** conforman nuestro **equipo humano**, caracterizados por su gran capacidad de **compromiso, implicación y trabajo en equipo**, lo que nos permite afrontar los retos que se plantean día a día con el máximo rigor, seriedad y obteniendo los mejores resultados para el cliente.

La internacionalización es uno de los grandes valores del Grupo y esta diversificación de mercados le ha permitido fortalecerse incluso en los momentos más duros para el sector en España. Igualmente, la **continua adaptación del producto** para los mercados más exigentes le lleva a ser una empresa de vanguardia en calidad y diseño. Estamos presente actualmente en **más de 40 países en los 5 continentes**.

*The Top Form Group began its activity **1970**, manufacturing and distributing **furniture components**. The Group's expertise in the market and the quality of our products are our main assets.*

*All the manufacturing facilities of the Group are placed in Spain, our Head Office is placed in **Yuncos (Toledo)** and our four factories, that have more than **140.000 square meters of industrial surface**, are placed between **Madrid and Toledo**, always committed with the highest standards of quality and the respect of the environment. The Top Form Group is one of the few companies that have full control of every piece in the production process, from the furniture components to the finished product.*

*The Top Form Group has **11 logistic and assembly hubs in 3 different countries** that allows us to be close to the final user, always offering the best service backed up by our 50 years experience in the field.*

*Our more than **400 employees** are characterized by its great capacity for commitment and **teamwork**, enable us to face the everyday's challenges with the utmost **rigor, seriousness and achieving** the best results for the clients.*

*The internationalisation of our business is one of the main assets of the Group, it has helped us out during the tough times for the furniture industry in Spain. Furthermore, the **continuous adaptation of our products** to the most demanding markets has boosted our quality and design. Top Form is in **more than 40 countries in the 5 continents**.*



Proyectos sociales / Social Projects

La defensa de los derechos humanos también es importante para el Grupo Top Form. A través de organizaciones sin ánimo de lucro y de fundaciones que promueven y buscan la transformación social y la mejora de la calidad de vida de las personas, colaboramos con proyectos donde nos comprometemos a ser partícipes con causas sociales y solidarias. En los últimos años nos hemos sumado al programa UNIDOS de la ONG **Save the Children**. Nuestro reto es ayudar a hacer desaparecer la pobreza infantil en España y que todos los niños puedan acceder a la educación. Además colaboramos con otros determinados programas y organismos aportando un porcentaje de nuestras ventas a favor de acciones humanitarias.

*The defence of human rights is also important for Top Form Group, through non-profit organizations and foundations it promotes and seeks social transformation and improves the quality of life of needed people. We collaborate with projects with social causes and solidarity. We joined UNIDOS, a program of the NGO **Save the Children**. Our challenge is to help make child poverty disappear in Spain and make all children can have access to education. We also collaborate with other specific programmes and organizations with a percentage of our sales.*



Compromiso e innovación / Commitment & Innovation

La compañía desde sus orígenes ha creído firmemente que la calidad y competitividad de un producto nace de controles eficientes, la aplicación de nuevas tecnologías y la apuesta por el desarrollo continuo en todo el ciclo de fabricación. Por ello cuidamos hasta el último detalle los aspectos relativos a calidad y respeto del medio ambiente.

Gracias al esfuerzo y compromiso en estas materias, disponemos de las siguientes certificaciones:



The company from its beginnings has firmly believed that the quality and competitiveness of a product is made of efficient controls. We use new technologies and commitment to continuous development throughout the manufacture cycle. We take care of every detail relative of Quality and respect for the environment.



Uno de los pilares fundamentales del Grupo es la apuesta continua por la **Investigación, Desarrollo e Innovación** de todos los productos de Top Form, que han situado a la organización en un referente de calidad y reputación en todo el sector.

Top Form cree que sin innovación no hay futuro, por eso el Grupo cuenta con una red de investigación sólida integrada por profesionales especializados, docentes y colaboradores asociados, con el objetivo de convertir sus conocimientos en productos de éxito, capaz de satisfacer las necesidades de nuestros clientes otorgando la máxima calidad.

Cumplimos 50 años, pero queremos seguir cumpliendo otros 50. Por ello, estamos inmersos en una enorme inversión industrial con maquinaria de última tecnología y procesos innovadores. Un gran reto, para seguir siendo líderes.

*One of the most important values is our **investigation, development and innovation** department. Our staff analyzes the market and the needs of our clients to develop new strategies and products.*

Top Form believes that without innovation there is no future. The Group has a solid research network made up of specialized professionals, teachers and associated collaborators that put their knowledge into successful products.

We are turning 50 years old, but we want to continue turning another 50. For this reason, we are immersed in a huge industrial investment with the latest technology machinery and innovative processes. A great challenge, to continue being leaders.

- El presente catálogo anula y sustituye a los anteriores, reservándose **Top Form Group** el derecho a modificarlo si las condiciones del mercado lo requieren o si existiera algún tipo de errata, siendo esta notificada al cliente y prevaleciendo ésta sobre las condiciones del catálogo.
- *The current catalogue cancels and replaces the previous ones. **Top Form Group** reserves the right to modify it if the market conditions require it or if a mistake was made. In these cases, the client will be notified and the modified condition will prevail over the one in the catalogue.*

PEDIDOS Y RECLAMACIONES / Orders and complaints:

- Sólo se aceptarán pedidos recibidos por e-mail o por fax (preferiblemente por e-mail a **pedidos@topformgroup.com**) incluyendo siempre las descripciones o códigos de la tarifa de producto.
- *Only the orders received by e-mail or fax (preferably by e-mail to **exportacion@topformgroup.com**) will be accepted, and these orders must always include the descriptions or the catalogue's codes from the Top Form's price list.*
- **Top Form Group** remitirá una confirmación por e-mail de cada pedido para su revisión. Si en un plazo de 24 horas hábiles no se hubiese recibido ninguna corrección, el pedido no podrá ser modificado. Todo cliente que quiera recibir esta confirmación de pedido, deberá pasar una solicitud a **comercial@topformgroup.com**, indicando la dirección de email donde quiere recibirla.
- ***Top Form Group** will send a confirmation e-mail for every order for the customer to review it. If after 24 hours no corrections have been received, the order will be confirmed. All the client who wants to receive this order confirmation, should send a request to **exportacion@topformgroup.com**, telling us the email address where he wants to receive it.*
- No se admitirá reclamación por diferencias en cantidades o defectos de trato severo, salvo constancia por escrito en el albarán de entrega del transportista.
- *No complaints regarding discrepancies in quantities or defects due to poor handling will be accepted unless written proof of it exists in the delivery note received from the shipper.*
- Todas las reclamaciones se remitirán por e-mail o por fax (preferiblemente por e-mail a **incidencias@topformgroup.com**) en un plazo nunca superior a 7 días naturales indicando siempre el número de pedido, albarán o factura, fecha de entrega y fotografías de los bienes dañados, para su correspondiente gestión.
- *All complaints shall be sent by e-mail or fax (preferably by e-mail to **exportacion@topformgroup.com**) before 7 calendar days, indicating the order number, the delivery note or invoice, and the date of delivery and pictures of the damaged items so that it can be properly processed.*
- No se aceptarán devoluciones de material sin que haya sido previamente autorizado.
- *No returns of material will we accepted without the Top Form's previous authorization.*
- Si se recoge material por causas ajenas a **Top Form Group**, se aplicará una penalización del 10% en concepto de gastos de gestión y transporte.
- *If our material is collected for reasons beyond **Top Form Group**, a 10% penalty will be applied for management and transportation expenses.*

GARANTIA / Warranty:

- Esta garantía cubre al comprador de cualquier producto suministrado por **Top Form Group** ante cualquier posible reclamación por defecto, no visible durante su manipulación y que pueda aparecer con el uso o con el paso del tiempo durante un período máximo de dos años desde su adquisición.
- *This warranty covers purchasers of any product supplied by **Top Form Group** against any possible claim for not visible defects during handling and which would appear after the use of the item or over time for a maximum period of two years after the purchase.*
- El comprador dirigirá la reclamación acompañada de toda la información necesaria a **Top Form Group**, el cual si reconoce defectuosa la parte afectada, y dentro de los límites de la garantía propondrá si corresponde la sustitución de la misma, siempre en las mismas condiciones originales de la compra.

En estos casos **Top Form Group** proveerá al distribuidor sin cargo alguno de:

A: Materiales nuevos de idénticas características a los originales.

B: En los casos en los cuales por fuerza mayor **(1)** esto no sea posible, **Top Form Group** ofrecerá una solución alternativa.

C: En ningún caso **Top Form Group** se hará cargo de los gastos ocasionados por el montaje/desmontaje/manipulación de ningún producto que no haya instalado.

- *The purchaser shall send its claim, along with all the necessary information, to **Top Form Group**, which, if it deems the affected part to be defective, and within the limits of the warranty, will replace the said item, always in the same original purchasing conditions. In these cases, **Top Form Group** will provide the distributor with the following, free of charge:*

A: *New materials that are identical to the original ones.*

B: *If this were not possible due to extraordinary circumstances **(1)**, Top Form will offer an alternative solution.*

C: *Under no circumstances will **Top Form Group** be responsible for expenses incurred during the assembly, disassembly, or handling of any product that they Top Form Group did not installed.*

LIMITES DE GARANTIA / Warranty limitations:

- Que usted haya comprado los productos directamente a **Top Form Group**.
- Que no hayan sido alterados desde su salida de fábrica.
- Que la reclamación no sea consecuencia de causas ajenas a **Top Form Group (2)**.
- Se excluyen de esta garantía las evoluciones normales que la laca o madera pueda sufrir con el paso del tiempo así como las diferencias de matiz de la misma.
 - (1)** Caducidad de los materiales, descatalogación de producto o imposibilidad de suministro por parte de nuestros proveedores, etc...
 - (2)** Filtraciones de agua, temperaturas demasiado elevadas, condiciones de humedad anormales, deficiencias en el montaje, golpes, usos abusivos no previstos, productos de limpieza no adecuados, cambios de tono debidos a la luz solar, caducidad del film protector (6 meses) etc...
- *The products must have been purchased directly from **Top Form Group**.*
- *The products must not have been altered since leaving the factory.*
- *The claim must not be due to reasons beyond the control of **Top Form Group (2)**.*
- *Normal changes that the lacquer or solid wood may suffer over time, as well as discolouration, are not covered by this warranty.*
 - (1)** *Discontinued materials, **Top Form Group** impossibility of being supplied etc.*
 - (2)** *Water leaks, excessively high temperatures, abnormal moisture conditions, faulty assembly, banging, unforeseen abuse, improper cleaning products, changes in tone caused by sunlight, wearing off of protective film (6 months), etc.*

CONDICIONES DE PAGO / Payment conditions:

- En todos los impagados se cargarán los gastos bancarios correspondientes y no se servirá ningún pedido si se encuentra pendiente el cobro de algún efecto devuelto o factura vencida.
- Las modificaciones de vencimiento o los vencimientos aplazados serán penalizados con un recargo del 8% anual de intereses en la demora del pago.
- El plazo máximo de pago quedara establecido por la ley 16/2009 de servicios de pago por la legislación vigente.
- *For all unpaid orders, all the bank expenses will be added to the total amount, and no order will be delivered if the payment has not been made or the invoice is past due. Past due or extended invoices will be penalised with an annual charge of 8% for interest on the delayed payment.*
- *The maximum payment period is set forth by Law 16/2009 on the payment for services under the Spanish Law.*



011 1 TABLEROS Y BANDAS / Boards and bars

- 013 A - DESLINE
- 035 B - EXTREME
- 041 C - ECO-FEEL
- 053 D - PREMIUM
- 067 E - TOP-COLLECTION

073 2 ENCIMERAS Y MOSTRADORES / Worktops and bartops

- 075 A - TOP-COLLECTION
- 087 B - GOLDEN-TOP
- 095 C - LUNION
- 101 D - CUSTOM

117 3 PUERTAS, COSTADOS Y REGLETAS / Doors, cover panels and fillers

- 119 A - DESLINE
- 169 B - EXTREME
- 195 C - ECO-FEEL
- 227 D - PREMIUM
- 239 E - SPRIGN
- 251 F - WOOD
- 259 G - GLASS

265 4 COMPLEMENTOS / Supplements

- 266 A - DESLINE
- 267 B - EXTREME
- 269 C - ECO-FEEL
- 270 D - PREMIUM
- 271 E - TOP-COLLECTION

273 5 MODULOS / Cabinets

- 275 A - MODULOS EN KIT / Flat pack cabinets
- 287 B - COMPLEMENTOS PARA MODULOS / Supplements for cabinets

291 6 HERRAJES Y ACCESORIOS / Kitchen Wardware

- 293 A - TIRADORES / Handles
- 309 B - ACCESORIOS DE MONTAJE / Mounting accessories
- 337 C - ACCESORIOS DE ACABADO / Other kitchen accessories
- 351 D - CAJONES Y CACEROLEROS / Drawers and pan drawers
- 379 E - ACCESORIOS DE INTERIOR / Interior accessories
- 399 F - FREGADEROS Y GRIFOS / Sinks and taps



1.

TABLEROS Y BANDAS

Boards and bars



TOP FORM

A.

desline mfc



TOP FORM

TABLERO

Board

■ CARACTERÍSTICAS TÉCNICAS:

Terminación: en recto.
 Soporte: tablero aglomerado.
 Recubrimiento: melamina decorativa acabada en mate.
 Contracara: similar acabado soft.
 Adhesivo: resina melaminica.
 Espesor: 19/22 mm.

■ FEATURES:

Finish: straight.
 Core: particle board.
 Covering: decorative melamine matt finish.
 Backside: similar colour soft finish.
 Adhesive: melamine resin.
 Thickness: 19/22 mm.

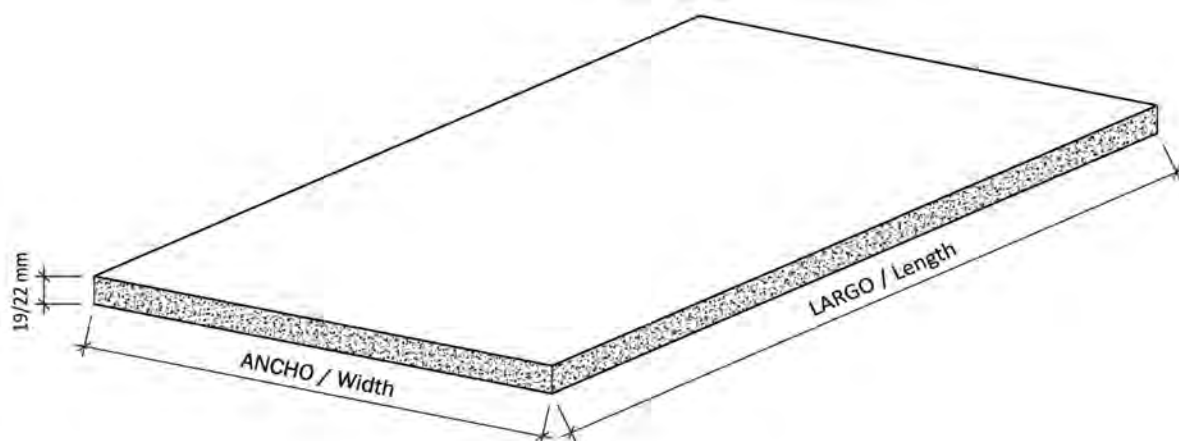
**■ CARACTERÍSTICAS TÉCNICAS:**

- Paquete estándar 10 unidades por medida y diseño.
- Por unidad, consultar condiciones.

■ FEATURES:

- Standard package 10 units per measurement and design.
- Per unit, ask about conditions.

MEDIDAS Y PESOS Dimensions and weights	
LARGO X ANCHO Length x width	PESO TABLERO Board weight
2800x2070x19 mm.	74,90 kg.
2850x2070x19 mm.	76,25 kg.
3660x2050x19 mm.	97,00 kg.
2800x2070x22 mm.	86,70 kg.

Dimensiones según diseño.
 Dimensions according to design.

DISEÑOS TABLERO 19 mm

19 mm Designs board

	REFERENCIA <i>Reference</i>
	Aguamarina AGM-834 SEF
	MEDIDA <i>Measure</i>
	2800x2070x19
CÓDIGO / <i>Code</i>	
9302846	

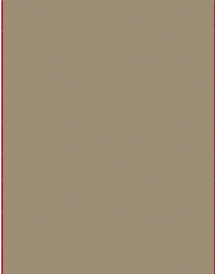
	REFERENCIA <i>Reference</i>
	Arena ARB-810 SEF
	MEDIDA <i>Measure</i>
	2850x2070x19
CÓDIGO / <i>Code</i>	
9302599	

	REFERENCIA <i>Reference</i>
	Arena claro ARC-837 SOFT
	MEDIDA <i>Measure</i>
	2800x2070x19
CÓDIGO / <i>Code</i>	
9302817	

	REFERENCIA <i>Reference</i>
	Blanco fresno BLC-853 PF
	MEDIDA <i>Measure</i>
	2800x2070x19
CÓDIGO / <i>Code</i>	
9302908	

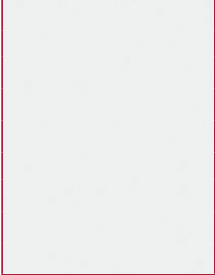
	REFERENCIA <i>Reference</i>
	Blanco polar BLP-805 SEF
	MEDIDA <i>Measure</i>
	2850x2070x19
CÓDIGO / <i>Code</i>	
9302468	

	REFERENCIA <i>Reference</i>
	Cacao chocolate CAC-839 SOFT
	MEDIDA <i>Measure</i>
	2800x2070x19
CÓDIGO / <i>Code</i>	
9302819	

	REFERENCIA <i>Reference</i>
	Nogal rústico CLC-828 SYNCH
	MEDIDA <i>Measure</i>
	3050x2070x19
CÓDIGO / <i>Code</i>	
9302836	

	REFERENCIA <i>Reference</i>
	Nogal alfil CLN-829 SYNCH
	MEDIDA <i>Measure</i>
	3050x2070x19
CÓDIGO / <i>Code</i>	
9302837	

	REFERENCIA <i>Reference</i>
	Nogal pacífico CLO-826 SYNCH
	MEDIDA <i>Measure</i>
	3050x2070x19
CÓDIGO / <i>Code</i>	
9302834	

	REFERENCIA <i>Reference</i>
	Nogal natural ELN-915 VH
	MEDIDA <i>Measure</i>
	3660x2050x19
CÓDIGO / <i>Code</i>	
8700002	

	REFERENCIA <i>Reference</i>
	Nogal negro ENC-821 SPIRIT
	MEDIDA <i>Measure</i>
	2800x2070x19
CÓDIGO / <i>Code</i>	
9302844	

	REFERENCIA <i>Reference</i>
	Nogal italiano EXP-823 SPIRIT
	MEDIDA <i>Measure</i>
	2800x2070x19
CÓDIGO / <i>Code</i>	
9302845	

	REFERENCIA <i>Reference</i>
	Gris antacita GAN-811 SEF
	MEDIDA <i>Measure</i>
	2850x2070x19
CÓDIGO / <i>Code</i>	
9302600	

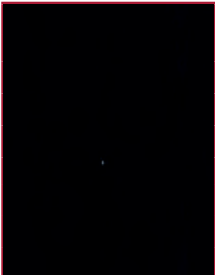
	REFERENCIA <i>Reference</i>
	Negro GLP-283 SOFT
	MEDIDA <i>Measure</i>
	2800x2070x19
CÓDIGO / <i>Code</i>	
9302818	

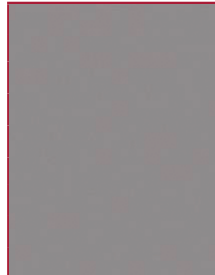
	REFERENCIA <i>Reference</i>
	Gris claro GRC-836 SOFT
	MEDIDA <i>Measure</i>
	2800x2070x19
CÓDIGO / <i>Code</i>	
9302816	

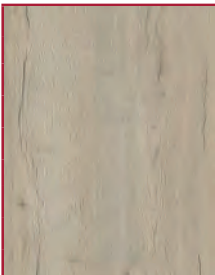
	REFERENCIA <i>Reference</i>
	Roble nudos blanco HFX-176 RG
	MEDIDA <i>Measure</i>
	2800x2070x19
CÓDIGO / <i>Code</i>	
9302759	

	REFERENCIA <i>Reference</i>
	Roble nudos natural HFX-180 RG
	MEDIDA <i>Measure</i>
	2800x2070x19
CÓDIGO / <i>Code</i>	
9302760	

	REFERENCIA <i>Reference</i>
	Roble nudos tabaco HFX-181 RG
	MEDIDA <i>Measure</i>
	2800x2070x19
CÓDIGO / <i>Code</i>	
9302761	

DISEÑOS TABLERO 19 mm

19 mm Designs board

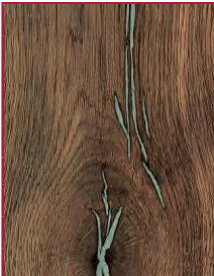
	REFERENCIA <i>Reference</i>
	Roble nudos zinc HFX-376 RG
	MEDIDA <i>Measure</i>
	2800x2070x19
CÓDIGO / <i>Code</i>	
9302812	

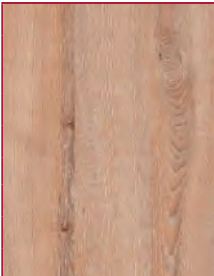
	REFERENCIA <i>Reference</i>
	Roble café MES-799 V.V
	MEDIDA <i>Measure</i>
	2850x2070x19
CÓDIGO / <i>Code</i>	
9301880	

	REFERENCIA <i>Reference</i>
	Roble claro OAC-809 PW
	MEDIDA <i>Measure</i>
	2800x2070x19
CÓDIGO / <i>Code</i>	
9302487	

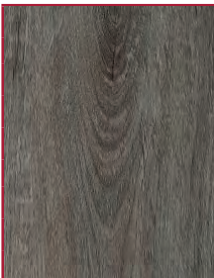
	REFERENCIA <i>Reference</i>
	Roble elegance OAD-822 FUN
	MEDIDA <i>Measure</i>
	2800x2070x19
CÓDIGO / <i>Code</i>	
9302850	

	REFERENCIA <i>Reference</i>
	Roble avellana OAM-806 FUN
	MEDIDA <i>Measure</i>
	2850x2070x19
CÓDIGO / <i>Code</i>	
9302539	

	REFERENCIA <i>Reference</i>
	Roble aneto OAN-807 FUN
	MEDIDA <i>Measure</i>
	2850x2070x19
CÓDIGO / <i>Code</i>	
9302488	

	REFERENCIA <i>Reference</i>
	Roble tostado OAT-808 PW
	MEDIDA <i>Measure</i>
	2800x2070x19
CÓDIGO / <i>Code</i>	
9302486	

	REFERENCIA <i>Reference</i>
	Olmo tostado PNH-003 RG
	MEDIDA <i>Measure</i>
	2800x2070x19
CÓDIGO / <i>Code</i>	
9302459	

	REFERENCIA <i>Reference</i>
	Olmo natural PNH-004 RG
	MEDIDA <i>Measure</i>
	2800x2070x19
CÓDIGO / <i>Code</i>	
9002460	

	REFERENCIA <i>Reference</i>
	Rojo RED-840 SOFT
	MEDIDA <i>Measure</i>
	2800x2070x19
CÓDIGO / <i>Code</i>	
9302820	

	REFERENCIA <i>Reference</i>
	Roble miel RHO-027 RG
	MEDIDA <i>Measure</i>
	2800x2070x19
CÓDIGO / <i>Code</i>	
9301742	

	REFERENCIA <i>Reference</i>
	Roble coñac RSC-833 RG
	MEDIDA <i>Measure</i>
	2800x2070x19
CÓDIGO / <i>Code</i>	
9302814	

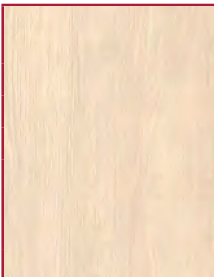
	REFERENCIA <i>Reference</i>
	Roble azúcar RSO-029 RG
	MEDIDA <i>Measure</i>
	2800x2070x19
CÓDIGO / <i>Code</i>	
9301744	

	REFERENCIA <i>Reference</i>
	Teja RTE-835 SOFT
	MEDIDA <i>Measure</i>
	2800x2070x19
CÓDIGO / <i>Code</i>	
9302815	

	REFERENCIA <i>Reference</i>
	Roble tropical SON-798 V.V
	MEDIDA <i>Measure</i>
	2850x2070x19
CÓDIGO / <i>Code</i>	
9301879	

	REFERENCIA <i>Reference</i>
	Nogal tostado TOS-824 RG
	MEDIDA <i>Measure</i>
	3050x2070x19
CÓDIGO / <i>Code</i>	
9302832	

DISEÑOS TABLERO 22 mm

22 mm Designs board

	REFERENCIA <i>Reference</i>
	Aguamarina AGM-834 SEF
	MEDIDA <i>Measure</i>
	2800x2070x22
CÓDIGO / <i>Code</i>	
9302849	

	REFERENCIA <i>Reference</i>
	Arena ARB-810 SEF
	MEDIDA <i>Measure</i>
	2800x2070x22
CÓDIGO / <i>Code</i>	
9302665	

	REFERENCIA <i>Reference</i>
	Arena claro ARC-837 SOFT
	MEDIDA <i>Measure</i>
	2800x2070x22
CÓDIGO / <i>Code</i>	
9302826	

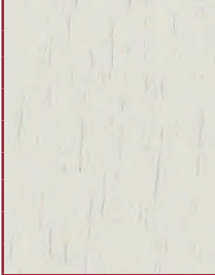
	REFERENCIA <i>Reference</i>
	Blanco fresno BLC-853 PF
	MEDIDA <i>Measure</i>
	2800x2070x22
CÓDIGO / <i>Code</i>	
9302909	

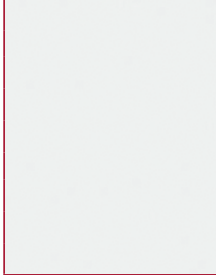
	REFERENCIA <i>Reference</i>
	Blanco polar BLP-805 SEF
	MEDIDA <i>Measure</i>
	2800x2070x22
CÓDIGO / <i>Code</i>	
9302666	

	REFERENCIA <i>Reference</i>
	Cacao chocolate CAC-839 SOFT
	MEDIDA <i>Measure</i>
	2800x2070x22
CÓDIGO / <i>Code</i>	
9302828	

	REFERENCIA <i>Reference</i>
	Nogal rústico CLC-828 SYNCH
	MEDIDA <i>Measure</i>
	3050x2070x22
CÓDIGO / <i>Code</i>	
9302842	

	REFERENCIA <i>Reference</i>
	Nogal alfil CLN-829 SYNCH
	MEDIDA <i>Measure</i>
	3050x2070x22
CÓDIGO / <i>Code</i>	
9302843	

	REFERENCIA <i>Reference</i>
	Nogal pacífico CLO-826 SYNCH
	MEDIDA <i>Measure</i>
	3050x2070x22
CÓDIGO / <i>Code</i>	
9302840	

	REFERENCIA <i>Reference</i>
	Nogal negro ENC-821 SPIRIT
	MEDIDA <i>Measure</i>
	2800x2070x22
CÓDIGO / <i>Code</i>	
9302847	

	REFERENCIA <i>Reference</i>
	Nogal italiano EXP-823 SPIRIT
	MEDIDA <i>Measure</i>
	2800x2070x22
CÓDIGO / <i>Code</i>	
9302848	

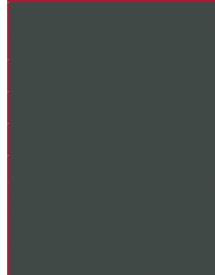
	REFERENCIA <i>Reference</i>
	Gris antacita GAN-811 SEF
	MEDIDA <i>Measure</i>
	2800x2070x22
CÓDIGO / <i>Code</i>	
9302664	

	REFERENCIA <i>Reference</i>
	Negro GLP-283 SOFT
	MEDIDA <i>Measure</i>
	2800x2070x22
CÓDIGO / <i>Code</i>	
9302827	

	REFERENCIA <i>Reference</i>
	Gris claro GRC-836 SOFT
	MEDIDA <i>Measure</i>
	2800x2070x22
CÓDIGO / <i>Code</i>	
9302825	

	REFERENCIA <i>Reference</i>
	Roble nudos blanco HFX-176 RG
	MEDIDA <i>Measure</i>
	2800x2070x22
CÓDIGO / <i>Code</i>	
93022753	

	REFERENCIA <i>Reference</i>
	Roble nudos natural HFX-180 RG
	MEDIDA <i>Measure</i>
	2800x2070x22
CÓDIGO / <i>Code</i>	
9302744	

	REFERENCIA <i>Reference</i>
	Roble nudos tabaco HFX-181 RG
	MEDIDA <i>Measure</i>
	2800x2070x22
CÓDIGO / <i>Code</i>	
9302745	

	REFERENCIA <i>Reference</i>
	Roble nudos zinc HFX-376 RG
	MEDIDA <i>Measure</i>
	2800x2070x22
CÓDIGO / <i>Code</i>	
9302821	

DISEÑOS TABLERO 22 mm

22 mm Designs board

	REFERENCIA <i>Reference</i>
	Roble café MES-799 V.V
	MEDIDA <i>Measure</i>
	2800x2070x22
CÓDIGO / <i>Code</i>	
9302659	

	REFERENCIA <i>Reference</i>
	Roble avellana OAM-806 FUN
	MEDIDA <i>Measure</i>
	2800x2070x22
CÓDIGO / <i>Code</i>	
9302661	

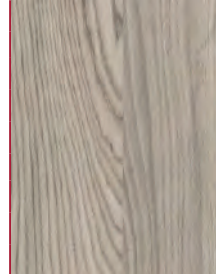
	REFERENCIA <i>Reference</i>
	Olmo tostado PNH-003 RG
	MEDIDA <i>Measure</i>
	2800x2070x22
CÓDIGO / <i>Code</i>	
9901914	

	REFERENCIA <i>Reference</i>
	Olmo natural PNH-004 RG
	MEDIDA <i>Measure</i>
	2800x2070x22
CÓDIGO / <i>Code</i>	
9901915	

	REFERENCIA <i>Reference</i>
	Rojo RED-840 SOFT
	MEDIDA <i>Measure</i>
	2800x2070x22
CÓDIGO / <i>Code</i>	
9302829	

	REFERENCIA <i>Reference</i>
	Roble miel RHO-027 RG
	MEDIDA <i>Measure</i>
	2800x2070x22
CÓDIGO / <i>Code</i>	
9302851	

	REFERENCIA <i>Reference</i>
	Roble coñac RSC-833 RG
	MEDIDA <i>Measure</i>
	2800x2070x22
CÓDIGO / <i>Code</i>	
9302823	

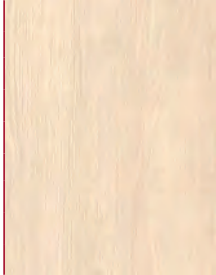
	REFERENCIA <i>Reference</i>
	Roble azúcar RSO-029 RG
	MEDIDA <i>Measure</i>
	2800x2070x22
CÓDIGO / <i>Code</i>	
9302660	

	REFERENCIA <i>Reference</i>
	Teja RTE-835 SOFT
	MEDIDA <i>Measure</i>
	2800x2070x22
CÓDIGO / <i>Code</i>	
9302824	

	REFERENCIA <i>Reference</i>
	Roble tropical SON-798 V.V
	MEDIDA <i>Measure</i>
	2800x2070x22
CÓDIGO / <i>Code</i>	
9302663	

	REFERENCIA <i>Reference</i>
	Nogal tostado TOS-824 RG
	MEDIDA <i>Measure</i>
	3050x2070x19
CÓDIGO / <i>Code</i>	
9302838	

BANDA INTEGRADA "J"

"J" Integrated bar

■ CARACTERÍSTICAS TÉCNICAS:

Terminacion: perfil tirador postformado tipo "J".
 Soporte: tablero aglomerado.
 Recubrimiento: melamina decorativa acabada en mate con diseños en horizontal y film protector.
 Contracara: similar acabado soft.
 Adhesivo: resina melaminica.
 Espesor: 19/22 mm.

■ FEATURES:

Finish: profile handle postforming type "J".
 Core: particle board.
 Covering: decorative melamine matt finish with horizontal designs and protective film.
 Backside: similar colour soft finish.
 Adhesive: melamine resin.
 Thickness: 19/22 mm.

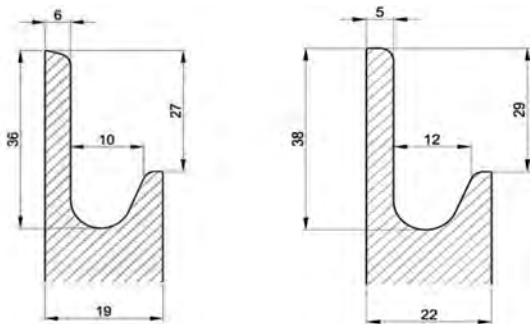
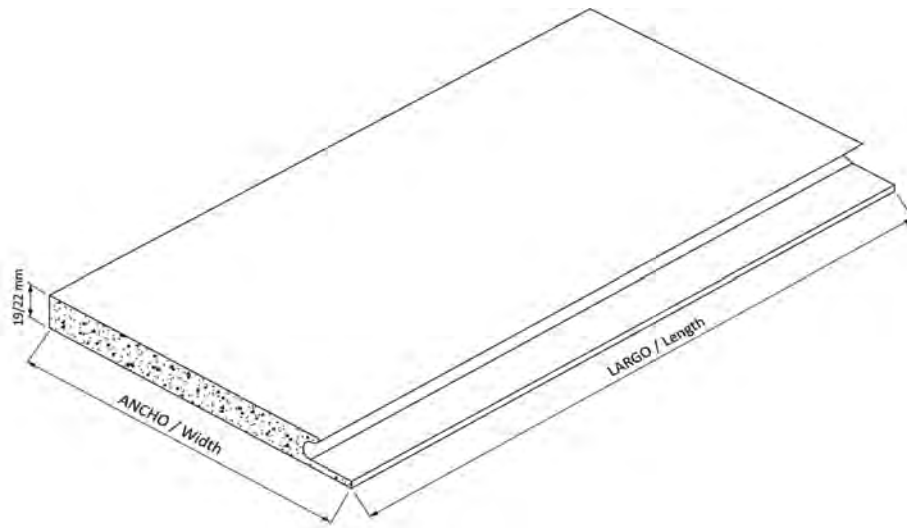

■ CARACTERÍSTICAS TÉCNICAS:

- Paquete estándar 10 unidades por medida y diseño.
- Por unidad, consultar condiciones.

■ FEATURES:

- Standard package 10 units per measurement and design.
- Per unit, ask about conditions.

MEDIDAS Y PESOS Dimensions and weights	
LARGO X ANCHO Length x width	PESO BANDA Bar weight
2800x279x19/22 mm.	9,06/10,49 kg.
2800x349x19/22 mm.	12,66/14,66 kg.
2800x430x19/22 mm.	14,98/17,35 kg.
2800x449x19/22 mm.	16,28/18,85 kg.
2800x630x19/22 mm.	21,95/25,42 kg.
2800x699x19/22 mm.	25,32/29,32 kg.
2800x730x19/22 mm.	25,43/29,45 kg.
2800x830x19/22 mm.	28,92/33,49 kg.
2800x899x19/22 mm.	32,55/37,70 kg.
2800x930x19/22 mm.	33,64/38,96 kg.
2800x1299x19/22 mm.	45,23/52,37 kg.

Dimensiones según diseño.
 Dimensions according to design.

DISEÑOS BANDA INTEGRADA "J" 19 mm

19 mm designs "J" integrated bar

REFERENCIA Reference	ANCHO Widht	CÓDIGO Code
Aguamarina AGM-834 SEF	279	81J0620
	349	81J0621
	430	81J0622
	449	81J0623
	630	81J0624
	699	81J0625
	730	81J0626
	830	81J0627
	899	81J0628
	930	81J0629
	1299	81J0630
	LARGO / Lenght	
	2800	

REFERENCIA Reference	ANCHO Widht	CÓDIGO Code
Arena ARB-810 SEF	279	81J0167
	349	81J0185
	430	81J0168
	449	81J0186
	630	81J0169
	699	81J0187
	730	81J0170
	830	81J0171
	899	81J0188
	930	81J0172
	1299	81J0174
	LARGO / Lenght	
	2850	

REFERENCIA Reference	ANCHO Widht	CÓDIGO Code
Arena claro ARC-837 SOFT	279	81J0653
	349	81J0654
	430	81J0655
	449	81J0656
	630	81J0657
	699	81J0658
	730	81J0659
	830	81J0660
	899	81J0661
	930	81J0662
	1299	81J0663
	LARGO / Lenght	
	2800	

REFERENCIA Reference	ANCHO Widht	CÓDIGO Code
Blanco fresno BLC-853 PF	279	81J0719
	349	81J0720
	430	81J0721
	449	81J0722
	630	81J0723
	699	81J0724
	730	81J0725
	830	81J0726
	899	81J0727
	930	81J0728
	1299	81J0729
	LARGO / Lenght	
	2800	

REFERENCIA Reference	ANCHO Widht	CÓDIGO Code
Blanco polar BLP-805 SEF	279	81J0129
	349	81J0130
	430	81J0131
	449	81J0132
	630	81J0133
	699	81J0134
	730	81J0135
	830	81J0136
	899	81J0137
	930	81J0138
	1299	81J0140
	LARGO / Lenght	
	2850	

REFERENCIA Reference	ANCHO Widht	CÓDIGO Code
Blanco-Nogal polar BLP-805/ELN-915 SEF	279	81J0143
	349	81J0144
	430	81J0145
	449	81J0146
	630	81J0147
	699	81J0148
	730	81J0149
	830	81J0150
	899	81J0151
	930	81J0152
	1299	81J0154
	LARGO / Lenght	
	2850	

REFERENCIA Reference	ANCHO Widht	CÓDIGO Code
Cacao chocolate CAC-839 SOFT	279	81J0675
	349	81J0676
	430	81J0677
	449	81J0678
	630	81J0679
	699	81J0680
	730	81J0681
	830	81J0682
	899	81J0683
	930	81J0684
	1299	81J0685
	LARGO / Lenght	
	2800	

REFERENCIA Reference	ANCHO Widht	CÓDIGO Code
Nogal rústico CLC-828 SYNCH	279	81J0576
	349	81J0577
	430	81J0578
	449	81J0579
	630	81J0580
	699	81J0581
	730	81J0582
	830	81J0583
	899	81J0584
	930	81J0585
	1299	81J0586
	LARGO / Lenght	
	3050	

REFERENCIA Reference	ANCHO Widht	CÓDIGO Code
Nogal alfil CLN-829 SYNCH	279	81J0587
	349	81J0588
	430	81J0589
	449	81J0590
	630	81J0591
	699	81J0592
	730	81J0593
	830	81J0594
	899	81J0595
	930	81J0596
	1299	81J0597
	LARGO / Lenght	
	3050	

REFERENCIA Reference	ANCHO Widht	CÓDIGO Code
Nogal pacífico CLO-826 SYNCH	279	81J0565
	349	81J0566
	430	81J0567
	449	81J0568
	630	81J0569
	699	81J0570
	730	81J0571
	830	81J0572
	899	81J0573
	930	81J0574
	1299	81J0575
	LARGO / Lenght	
	3050	

REFERENCIA Reference	ANCHO Widht	CÓDIGO Code
Nogal natural ELN-915 VH	279	81J0059
	349	81J0060
	430	81J0061
	449	81J0062
	630	81J0063
	699	81J0064
	730	81J0065
	830	81J0066
	899	81J0067
	930	81J0068
	1299	81J0070
	LARGO / Lenght	
	3660	

REFERENCIA Reference	ANCHO Widht	CÓDIGO Code
Nogal negro ENC-821 SPIRIT	279	81J0532
	349	81J0533
	430	81J0534
	449	81J0535
	630	81J0536
	699	81J0537
	730	81J0538
	830	81J0539
	899	81J0540
	930	81J0541
	1299	81J0542
	LARGO / Lenght	
	2800	

DISEÑOS BANDA INTEGRADA "J" 19 mm

19 mm designs "J" integrated bar

REFERENCIA Reference	ANCHO Widht	CÓDIGO Code
Nogal italiano	279	81J0543
EXP-823 SPIRIT	349	81J0544
	430	81J0545
	449	81J0546
	630	81J0547
	699	81J0548
	730	81J0549
	830	81J0550
	899	81J0551
	930	81J0552
	1299	81J0553
	LARGO / Lenght	
	2800	

REFERENCIA Reference	ANCHO Widht	CÓDIGO Code
Gris antacita	279	81J0175
GAN-811 SEF	349	81J0191
	430	81J0176
	449	81J0192
	630	81J0177
	699	81J0193
	730	81J0178
	830	81J0179
	899	81J0194
	930	81J0180
	1299	81J0182
	LARGO / Lenght	
	2850	

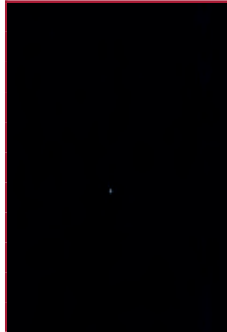
REFERENCIA Reference	ANCHO Widht	CÓDIGO Code
Negro	279	81J0664
GLP-283 SOFT	349	81J0665
	430	81J0666
	449	81J0667
	630	81J0668
	699	81J0669
	730	81J0670
	830	81J0671
	899	81J0672
	930	81J0673
	1299	81J0674
	LARGO / Lenght	
	2800	

REFERENCIA Reference	ANCHO Widht	CÓDIGO Code
Gris claro	279	81J0642
GRC-836 SOFT	349	81J0643
	430	81J0644
	449	81J0645
	630	81J0646
	699	81J0647
	730	81J0648
	830	81J0649
	899	81J0650
	930	81J0651
	1299	81J0652
	LARGO / Lenght	
	2800	

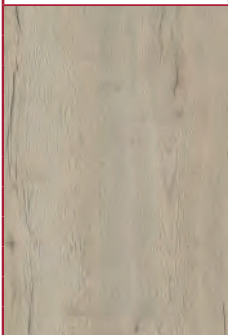
REFERENCIA Reference	ANCHO Widht	CÓDIGO Code
Roble nudos blanco	279	81J0466
HFX-176 RG	349	81J0467
	430	81J0468
	449	81J0469
	630	81J0470
	699	81J0471
	730	81J0472
	830	81J0473
	899	81J0474
	930	81J0475
	1299	81J0476
	LARGO / Lenght	
	2800	

REFERENCIA Reference	ANCHO Widht	CÓDIGO Code
Roble nudos natural	279	81J0477
HFX-180 RG	349	81J0478
	430	81J0479
	449	81J0480
	630	81J0481
	699	81J0482
	730	81J0483
	830	81J0484
	899	81J0485
	930	81J0486
	1299	81J0487
	LARGO / Lenght	
	2800	

REFERENCIA Reference	ANCHO Widht	CÓDIGO Code
Roble nudos tabaco	279	81J0488
HFX-181 RG	349	81J0489
	430	81J0490
	449	81J0491
	630	81J0492
	699	81J0493
	730	81J0494
	830	81J0495
	899	81J0496
	930	81J0497
	1299	81J0498
	LARGO / Lenght	
	2800	

REFERENCIA Reference	ANCHO Widht	CÓDIGO Code
Roble nudos zinc	279	81J0598
HFX-376 RG	349	81J0599
	430	81J0600
	449	81J0601
	630	81J0602
	699	81J0603
	730	81J0604
	830	81J0605
	899	81J0606
	930	81J0607
	1299	81J0608
	LARGO / Lenght	
	2800	

REFERENCIA Reference	ANCHO Widht	CÓDIGO Code
Roble café	279	81J0499
MES-799 V.V	349	81J0500
	430	81J0501
	449	81J0502
	630	81J0503
	699	81J0504
	730	81J0505
	830	81J0506
	899	81J0507
	930	81J0508
	1299	81J0509
	LARGO / Lenght	
	2850	

REFERENCIA Reference	ANCHO Widht	CÓDIGO Code
Roble claro	279	81J0429
OAC-809 PW	349	81J0454
	430	81J0430
	449	81J0455
	630	81J0431
	699	81J0456
	730	81J0432
	830	81J0433
	899	81J0457
	930	81J0434
	1299	81J0435
	LARGO / Lenght	
	2800	

REFERENCIA Reference	ANCHO Widht	CÓDIGO Code
Roble elegance	279	81J0708
OAD-822 FUN	349	81J0709
	430	81J0710
	449	81J0711
	630	81J0712
	699	81J0713
	730	81J0714
	830	81J0715
	899	81J0716
	930	81J0717
	1299	81J0718
	LARGO / Lenght	
	2800	

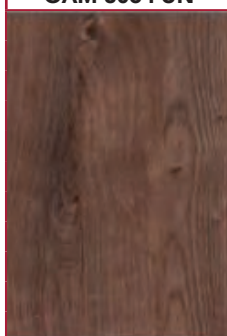
REFERENCIA Reference	ANCHO Widht	CÓDIGO Code
Roble avellana	279	81J0436
OAM-806 FUN	349	81J0458
	430	81J0437
	449	81J0459
	630	81J0438
	699	81J0460
	730	81J0439
	830	81J0440
	899	81J0461
	930	81J0441
	1299	81J0442
	LARGO / Lenght	
	2850	

DISEÑOS BANDA INTEGRADA "J" 19 mm

19 mm designs "J" integrated bar

REFERENCIA Reference	ANCHO Widht	CÓDIGO Code
Roble aneto	279	81J0708
OAN-807 FUN	349	81J0709
	430	81J0710
	449	81J0711
	630	81J0712
	699	81J0713
	730	81J0714
	830	81J0715
	899	81J0716
	930	81J0717
	1299	81J0718
	LARGO / Lenght	
	2800	

REFERENCIA Reference	ANCHO Widht	CÓDIGO Code
Roble tostado	279	81J0422
OAT-808 PW	349	81J0450
	430	81J0423
	449	81J0451
	630	81J0424
	699	81J0452
	730	81J0425
	830	81J0426
	899	81J0453
	930	81J0427
	1299	81J0428
	LARGO / Lenght	
	2800	

REFERENCIA Reference	ANCHO Widht	CÓDIGO Code
Olmo tostado	279	81J0101
PNH-003 RG	349	81J0102
	430	81J0103
	449	81J0104
	630	81J0105
	699	81J0106
	730	81J0107
	830	81J0108
	899	81J0109
	930	81J0110
	1299	81J0112
	LARGO / Lenght	
	2800	

REFERENCIA Reference	ANCHO Widht	CÓDIGO Code
Olmo natural	279	81J0115
PNH-004 RG	349	81J0116
	430	81J0117
	449	81J0118
	630	81J0119
	699	81J0120
	730	81J0121
	830	81J0122
	899	81J0123
	930	81J0124
	1299	81J0126
	LARGO / Lenght	
	2800	

REFERENCIA Reference	ANCHO Widht	CÓDIGO Code
Rojo	279	81J0686
RED-840 SOFT	349	81J0687
	430	81J0688
	449	81J0689
	630	81J0690
	699	81J0691
	730	81J0692
	830	81J0693
	899	81J0694
	930	81J0695
	1299	81J0696
	LARGO / Lenght	
	2800	

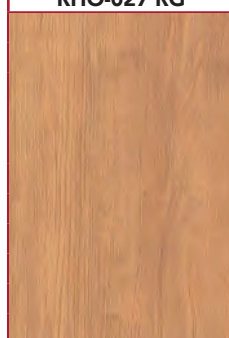
REFERENCIA Reference	ANCHO Widht	CÓDIGO Code
Roble miel	279	81J0510
RHO-027 RG	349	81J0511
	430	81J0512
	449	81J0513
	630	81J0514
	699	81J0515
	730	81J0516
	830	81J0517
	899	81J0518
	930	81J0519
	1299	81J0520
	LARGO / Lenght	
	2800	

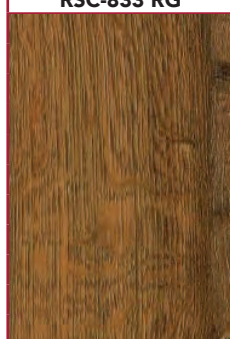
REFERENCIA Reference	ANCHO Widht	CÓDIGO Code
Roble coñac	279	81J0609
RSC-833 RG	349	81J0610
	430	81J0611
	449	81J0612
	630	81J0613
	699	81J0614
	730	81J0615
	830	81J0616
	899	81J0617
	930	81J0618
	1299	81J0619
	LARGO / Lenght	
	2800	

REFERENCIA Reference	ANCHO Widht	CÓDIGO Code
Roble azucar	279	81J0443
RSO-029 RG	349	81J0462
	430	81J0444
	449	81J0463
	630	81J0445
	699	81J0464
	730	81J0446
	830	81J0447
	899	81J0465
	930	81J0448
	1299	81J0449
	LARGO / Lenght	
	2800	

REFERENCIA Reference	ANCHO Widht	CÓDIGO Code
Teja	279	81J0631
RTE-835 SOFT	349	81J0632
	430	81J0633
	449	81J0634
	630	81J0635
	699	81J0636
	730	81J0637
	830	81J0638
	899	81J0639
	930	81J0640
	1299	81J0641
	LARGO / Lenght	
	2800	

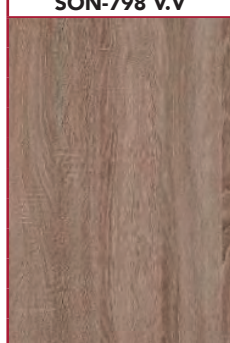
REFERENCIA Reference	ANCHO Widht	CÓDIGO Code
Roble tropical	279	81J0521
SON-798 V.V	349	81J0522
	430	81J0523
	449	81J0524
	630	81J0525
	699	81J0526
	730	81J0527
	830	81J0528
	899	81J0529
	930	81J0530
	1299	81J0531
	LARGO / Lenght	
	2850	

REFERENCIA Reference	ANCHO Widht	CÓDIGO Code
Nogal tostado	279	81J0554
TOS-824 RG	349	81J0555
	430	81J0556
	449	81J0557
	630	81J0558
	699	81J0559
	730	81J0560
	830	81J0561
	899	81J0562
	930	81J0563
	1299	81J0564
	LARGO / Lenght	
	3050	

DISEÑOS BANDA INTEGRADA "J" 22 mm
22 mm designs "J" integrated bar

REFERENCIA Reference	ANCHO Widht	CÓDIGO Code
Aguamarina	279	81J0818
AGM-834 SEF	349	81J0819
	430	81J0820
	449	81J0821
	630	81J0822
	699	81J0823
	730	81J0824
	830	81J0825
	899	81J0826
	930	81J0827
	1299	81J0828
	LARGO / Lenght	

REFERENCIA Reference	ANCHO Widht	CÓDIGO Code
Arena	279	81J0295
ARB-810 SEF	349	81J0296
	430	81J0297
	449	81J0298
	630	81J0299
	699	81J0300
	730	81J0301
	830	81J0302
	899	81J0303
	930	81J0304
	1299	81J0306
	LARGO / Lenght	

REFERENCIA Reference	ANCHO Widht	CÓDIGO Code
Arena claro	279	81J0851
ARC-837 SOFT	349	81J0852
	430	81J0853
	449	81J0854
	630	81J0855
	699	81J0856
	730	81J0857
	830	81J0858
	899	81J0859
	930	81J0860
	1299	81J0861
	LARGO / Lenght	

REFERENCIA Reference	ANCHO Widht	CÓDIGO Code
Blanco fresno	279	81J0895
BLC-853 PF	349	81J0896
	430	81J0897
	449	81J0898
	630	81J0899
	699	81J0900
	730	81J0901
	830	81J0902
	899	81J0903
	930	81J0904
	1299	81J0905
	LARGO / Lenght	

REFERENCIA Reference	ANCHO Widht	CÓDIGO Code
Blanco polar	279	81J0197
BLP-805 SEF	349	81J0198
	430	81J0199
	449	81J0200
	630	81J0201
	699	81J0202
	730	81J0203
	830	81J0204
	899	81J0205
	930	81J0206
	1299	81J0208
	LARGO / Lenght	

REFERENCIA Reference	ANCHO Widht	CÓDIGO Code
Cacao chocolate	279	81J0873
CAC-839 SOFT	349	81J0874
	430	81J0875
	449	81J0876
	630	81J0877
	699	81J0878
	730	81J0879
	830	81J0880
	899	81J0881
	930	81J0882
	1299	81J0883
	LARGO / Lenght	

REFERENCIA Reference	ANCHO Widht	CÓDIGO Code
Nogal rústico	279	81J0774
CLC-828 SYNCH	349	81J0775
	430	81J0776
	449	81J0777
	630	81J0778
	699	81J0779
	730	81J0780
	830	81J0781
	899	81J0782
	930	81J0783
	1299	81J0784
	LARGO / Lenght	

REFERENCIA Reference	ANCHO Widht	CÓDIGO Code
Nogal alfil	279	81J0785
CLN-829 SYNCH	349	81J0786
	430	81J0787
	449	81J0788
	630	81J0789
	699	81J0790
	730	81J0791
	830	81J0792
	899	81J0793
	930	81J0794
	1299	81J0795
	LARGO / Lenght	

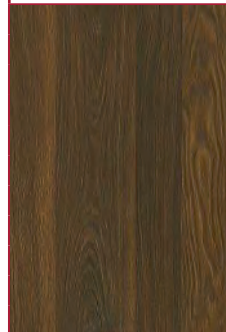
REFERENCIA Reference	ANCHO Widht	CÓDIGO Code
Nogal pacífico	279	81J0763
CLO-826 SYNCH	349	81J0764
	430	81J0765
	449	81J0766
	630	81J0767
	699	81J0768
	730	81J0769
	830	81J0770
	899	81J0771
	930	81J0772
	1299	81J0773
	LARGO / Lenght	

REFERENCIA Reference	ANCHO Widht	CÓDIGO Code
Nogal negro	279	81J0730
ENC-821 SPIRIT	349	81J0731
	430	81J0732
	449	81J0733
	630	81J0734
	699	81J0735
	730	81J0736
	830	81J0737
	899	81J0738
	930	81J0739
	1299	81J0740
	LARGO / Lenght	

REFERENCIA Reference	ANCHO Widht	CÓDIGO Code
Nogal italiano	279	81J0741
EXP-823 SPIRIT	349	81J0742
	430	81J0743
	449	81J0744
	630	81J0745
	699	81J0746
	730	81J0747
	830	81J0748
	899	81J0749
	930	81J0750
	1299	81J0751
	LARGO / Lenght	

REFERENCIA Reference	ANCHO Widht	CÓDIGO Code
Gris antacita	279	81J0281
GAN-811 SEF	349	81J0282
	430	81J0283
	449	81J0284
	630	81J0285
	699	81J0286
	730	81J0287
	830	81J0288
	899	81J0289
	930	81J0290
	1299	81J0292
	LARGO / Lenght	

DISEÑOS BANDA INTEGRADA "J" 22 mm

22 mm designs "J" integrated bar

REFERENCIA Reference	ANCHO Widht	CÓDIGO Code
Negro GLP-283 SOFT	279	81J0862
	349	81J0863
	430	81J0864
	449	81J0865
	630	81J0866
	699	81J0867
	730	81J0868
	830	81J0869
	899	81J0870
	930	81J0871
	1299	81J0872
	LARGO / Lenght	

REFERENCIA Reference	ANCHO Widht	CÓDIGO Code
Gris claro GRC-836 SOFT	279	81J0840
	349	81J0841
	430	81J0842
	449	81J0843
	630	81J0844
	699	81J0845
	730	81J0846
	830	81J0847
	899	81J0848
	930	81J0849
	1299	81J0850
	LARGO / Lenght	

REFERENCIA Reference	ANCHO Widht	CÓDIGO Code
Roble nudos blanco HFX-176 RG	279	81J0361
	349	81J1071
	430	81J0362
	449	81J0395
	630	81J0363
	699	81J0370
	730	81J0364
	830	81J0365
	899	81J0396
	930	81J0366
	1299	81J0367
	LARGO / Lenght	

REFERENCIA Reference	ANCHO Widht	CÓDIGO Code
Roble nudos natural HFX-180 RG	279	81J0347
	349	81J1072
	430	81J0348
	449	81J0397
	630	81J0349
	699	81J0368
	730	81J0350
	830	81J0351
	899	81J0398
	930	81J0352
	1299	81J0353
	LARGO / Lenght	

REFERENCIA Reference	ANCHO Widht	CÓDIGO Code
Roble nudos tabaco HFX-181 RG	279	81J0354
	349	81J1073
	430	81J0355
	449	81J0399
	630	81J0356
	699	81J0369
	730	81J0357
	830	81J0358
	899	81J0400
	930	81J0359
	1299	81J0360
	LARGO / Lenght	

REFERENCIA Reference	ANCHO Widht	CÓDIGO Code
Roble nudos zinc HFX-376 RG	279	81J0796
	349	81J0797
	430	81J0798
	449	81J0799
	630	81J0800
	699	81J0801
	730	81J0802
	830	81J0803
	899	81J0804
	930	81J0805
	1299	81J0806
	LARGO / Lenght	

REFERENCIA Reference	ANCHO Widht	CÓDIGO Code
Roble café MES-799 V.V	279	81J0267
	349	81J0268
	430	81J0269
	449	81J0270
	630	81J0271
	699	81J0272
	730	81J0273
	830	81J0274
	899	81J0275
	930	81J0276
	1299	81J0278
	LARGO / Lenght	

REFERENCIA Reference	ANCHO Widht	CÓDIGO Code
Roble avellana OAM-806 FUN	279	81J0225
	349	81J0226
	430	81J0227
	449	81J0228
	630	81J0229
	699	81J0230
	730	81J0231
	830	81J0232
	899	81J0233
	930	81J0234
	1299	81J0236
	LARGO / Lenght	

REFERENCIA Reference	ANCHO Widht	CÓDIGO Code
Olmo tostado PNH-003 RG	279	81J0155
	349	81J0156
	430	81J0308
	449	81J0157
	630	81J0309
	699	81J0158
	730	81J0310
	830	81J0311
	899	81J0159
	930	81J0312
	1299	81J0160
	LARGO / Lenght	

REFERENCIA Reference	ANCHO Widht	CÓDIGO Code
Olmo natural PNH-004 RG	279	81J0161
	349	81J0162
	430	81J0315
	449	81J0163
	630	81J0316
	699	81J0164
	730	81J0317
	830	81J0318
	899	81J0165
	930	81J0319
	1299	81J0166
	LARGO / Lenght	

REFERENCIA Reference	ANCHO Widht	CÓDIGO Code
Rojo RED-840 SOFT	279	81J0884
	349	81J0885
	430	81J0886
	449	81J0887
	630	81J0888
	699	81J0889
	730	81J0890
	830	81J0891
	899	81J0892
	930	81J0893
	1299	81J0894
	LARGO / Lenght	

REFERENCIA Reference	ANCHO Widht	CÓDIGO Code
Roble miel RHO-027 RG	279	81J1074
	349	81J1075
	430	81J1076
	449	81J1077
	630	81J1078
	699	81J1079
	730	81J1080
	830	81J1081
	899	81J1082
	930	81J1083
	1299	81J1084
	LARGO / Lenght	

DISEÑOS BANDA INTEGRADA "J" 22 mm

22 mm designs "J" integrated bar

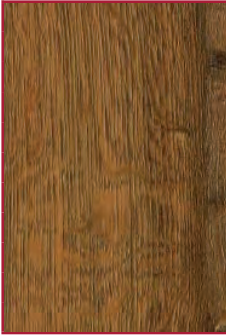
REFERENCIA Reference	ANCHO Widht	CÓDIGO Code
Roble coñac RSC-833 RG 	279	81J0807
	349	81J0808
	430	81J0809
	449	81J0810
	630	81J0811
	699	81J0812
	730	81J0813
	830	81J0814
	899	81J0815
	930	81J0816
	1299	81J0817
	LARGO / Lenght	

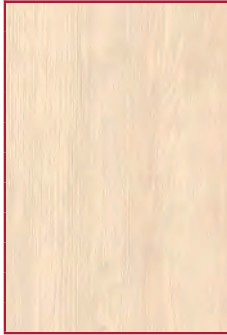
REFERENCIA Reference	ANCHO Widht	CÓDIGO Code
Roble azucar RSO-029 RG 	279	81J0211
	349	81J0212
	430	81J0213
	449	81J0214
	630	81J0215
	699	81J0216
	730	81J0217
	830	81J0218
	899	81J0219
	930	81J0220
	1299	81J0222
	LARGO / Lenght	

REFERENCIA Reference	ANCHO Widht	CÓDIGO Code
Teja RTE-835 SOFT 	279	81J0829
	349	81J0830
	430	81J0831
	449	81J0832
	630	81J0833
	699	81J0834
	730	81J0835
	830	81J0836
	899	81J0837
	930	81J0838
	1299	81J0839
	LARGO / Lenght	

REFERENCIA Reference	ANCHO Widht	CÓDIGO Code
Roble tropical SON-798 V.V 	279	81J0253
	349	81J0254
	430	81J0255
	449	81J0256
	630	81J0257
	699	81J0258
	730	81J0259
	830	81J0260
	899	81J0261
	930	81J0262
	1299	81J0264
	LARGO / Lenght	

REFERENCIA Reference	ANCHO Widht	CÓDIGO Code
Nogal tostado TOS-824 RG 	279	81J0752
	349	81J0753
	430	81J0754
	449	81J0755
	630	81J0756
	699	81J0757
	730	81J0758
	830	81J0759
	899	81J0760
	930	81J0761
	1299	81J0762
	LARGO / Lenght	

BANDA INTEGRADA "U"*"U" Integrated bar***■ CARACTERÍSTICAS TÉCNICAS:**

Terminación: perfil tirador postformado tipo "U".
 Soporte: tablero aglomerado.
 Recubrimiento: melamina decorativa acabada en mate con diseños en horizontal y film protector.
 Contracara: similar acabado soft.
 Adhesivo: resina melaminica.
 Espesor: 19/22 mm.

■ FEATURES:

Finish: profile handle postforming type "U".
 Core: particle board.
 Covering: decorative melamine matt finish with horizontal designs and protective film.
 Backside: similar colour soft finish.
 Adhesive: melamine resin.
 Thickness: 19/22 mm.

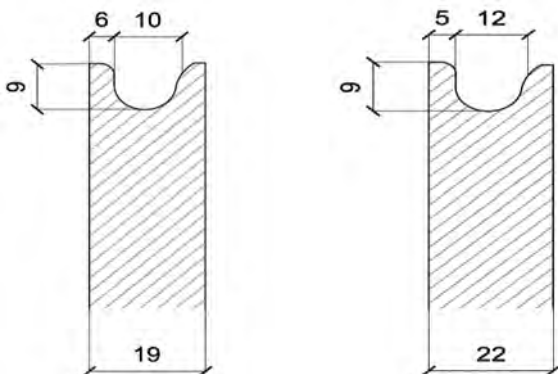
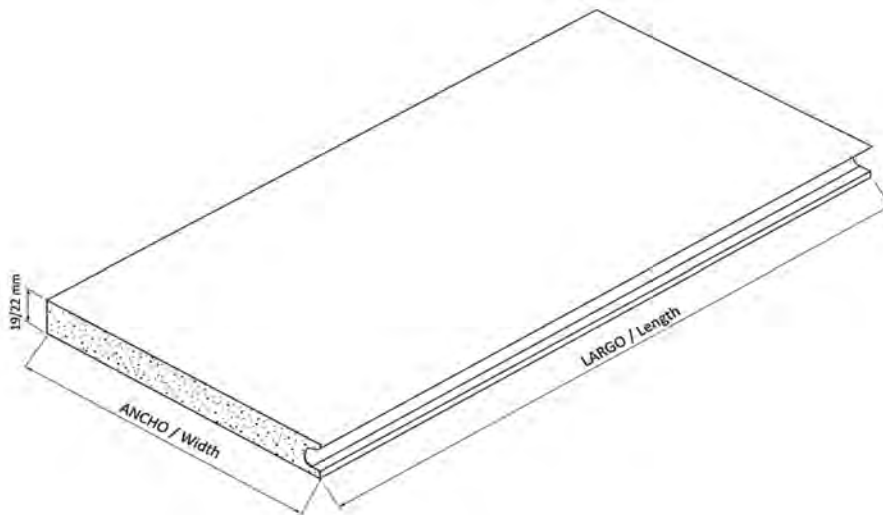
**■ CARACTERÍSTICAS TÉCNICAS:**

- Paquete estándar 10 unidades por medida y diseño.
- Por unidad, consultar condiciones.

■ FEATURES:

- Standard package 10 units per measurement and design.
- Per unit, ask about conditions.

MEDIDAS Y PESOS
Dimensions and weights

LARGO X ANCHO Length x width	PESO BANDA Bar weight
2800x279x19/22 mm.	9,06/10,49 kg.
2800x349x19/22 mm.	12,66/14,66 kg.
2800x430x19/22 mm.	14,98/17,35 kg.
2800x449x19/22 mm.	16,28/18,85 kg.
2800x630x19/22 mm.	21,95/25,42 kg.
2800x699x19/22 mm.	25,32/29,32 kg.
2800x730x19/22 mm.	25,43/29,45 kg.
2800x830x19/22 mm.	28,92/33,49 kg.
2800x899x19/22 mm.	32,55/37,70 kg.
2800x930x19/22 mm.	33,64/38,96 kg.
2800x1299x19/22 mm.	45,23/52,37 kg.

Dimensiones según diseño.
 Dimensions according to design.

DISEÑOS BANDA INTEGRADA "U" 19 mm

19 mm designs "U" integrated bar

REFERENCIA Reference	ANCHO Widht	CÓDIGO Code
Aguamarina	279	82U0606
AGM-834 SEF	349	82U0607
	430	82U0608
	449	82U0609
	630	82U0610
	699	82U0611
	730	82U0612
	830	82U0613
	899	82U0614
	930	82U0615
	1299	82U0616
	LARGO / Lenght	
	2800	

REFERENCIA Reference	ANCHO Widht	CÓDIGO Code
Arena	279	82U0386
ARB-810 SEF	349	82U0387
	430	82U0388
	449	82U0389
	630	82U0390
	699	82U0391
	730	82U0392
	830	82U0393
	899	82U0394
	930	82U0395
	1299	82U0396
	LARGO / Lenght	
	2800	

REFERENCIA Reference	ANCHO Widht	CÓDIGO Code
Arena claro	279	82U0639
ARC-837 SOFT	349	82U0640
	430	82U0641
	449	82U0642
	630	82U0643
	699	82U0644
	730	82U0645
	830	82U0646
	899	82U0647
	930	82U0648
	1299	82U0649
	LARGO / Lenght	
	2800	

REFERENCIA Reference	ANCHO Widht	CÓDIGO Code
Blanco fresno	279	82U0683
BLC-853 PF	349	82U0684
	430	82U0685
	449	82U0686
	630	82U0687
	699	82U0688
	730	82U0689
	830	82U0690
	899	82U0691
	930	82U0692
	1299	82U0693
	LARGO / Lenght	
	2800	

REFERENCIA Reference	ANCHO Widht	CÓDIGO Code
Blanco polar	279	82U0320
BLP-805 SEF	349	82U0321
	430	82U0322
	449	82U0323
	630	82U0324
	699	82U0325
	730	82U0326
	830	82U0327
	899	82U0328
	930	82U0329
	1299	82U0330
	LARGO / Lenght	
	2850	

REFERENCIA Reference	ANCHO Widht	CÓDIGO Code
Cacao chocolate	279	82U0661
CAC-839 SOFT	349	82U0662
	430	82U0663
	449	82U0664
	630	82U0665
	699	82U0666
	730	82U0667
	830	82U0668
	899	82U0669
	930	82U0670
	1299	82U0671
	LARGO / Lenght	
	2800	

REFERENCIA Reference	ANCHO Widht	CÓDIGO Code
Nogal rústico	279	82U0562
CLC-828 SYNCH	349	82U0563
	430	82U0564
	449	82U0565
	630	82U0566
	699	82U0567
	730	82U0568
	830	82U0569
	899	82U0570
	930	82U0571
	1299	82U0572
	LARGO / Lenght	
	3050	

REFERENCIA Reference	ANCHO Widht	CÓDIGO Code
Nogal alfil	279	82U0573
CLN-829 SYNCH	349	82U0574
	430	82U0575
	449	82U0576
	630	82U0577
	699	82U0578
	730	82U0579
	830	82U0580
	899	82U0581
	930	82U0582
	1299	82U0583
	LARGO / Lenght	
	3050	

REFERENCIA Reference	ANCHO Widht	CÓDIGO Code
Nogal pacífico	279	82U0551
CLO-826 SYNCH	349	82U0552
	430	82U0553
	449	82U0554
	630	82U0555
	699	82U0556
	730	82U0557
	830	82U0558
	899	82U0559
	930	82U0560
	1299	82U0561
	LARGO / Lenght	
	3050	

REFERENCIA Reference	ANCHO Widht	CÓDIGO Code
Nogal natural	279	82U0331
ELN-915 VH	349	82U0332
	430	82U0333
	449	82U0334
	630	82U0335
	699	82U0336
	730	82U0337
	830	82U0338
	899	82U0339
	930	82U0340
	1299	82U0341
	LARGO / Lenght	
	3660	

REFERENCIA Reference	ANCHO Widht	CÓDIGO Code
Nogal negro	279	82U0518
ENC-821 SPIRIT	349	82U0519
	430	82U0520
	449	82U0521
	630	82U0522
	699	82U0523
	730	82U0524
	830	82U0525
	899	82U0526
	930	82U0527
	1299	82U0528
	LARGO / Lenght	
	2800	

REFERENCIA Reference	ANCHO Widht	CÓDIGO Code
Nogal italiano	279	82U0529
EXP-823 SPIRIT	349	82U0530
	430	82U0531
	449	82U0532
	630	82U0533
	699	82U0534
	730	82U0535
	830	82U0536
	899	82U0537
	930	82U0538
	1299	82U0539
	LARGO / Lenght	
	2800	

DISEÑOS BANDA INTEGRADA "U" 19 mm

19 mm designs "U" integrated bar

REFERENCIA Reference	ANCHO Widht	CÓDIGO Code
Gris antacita	279	82U0397
GAN-811 SEF	349	82U0398
	430	82U0399
	449	82U0400
	630	82U0401
	699	82U0402
	730	82U0403
	830	82U0404
	899	82U0405
	930	82U0406
	1299	82U0407
	LARGO / Lenght	
	2800	

REFERENCIA Reference	ANCHO Widht	CÓDIGO Code
Negro	279	82U0650
GLP-283 SOFT	349	82U0651
	430	82U0652
	449	82U0653
	630	82U0654
	699	82U0655
	730	82U0656
	830	82U0657
	899	82U0658
	930	82U0659
	1299	82U0660
	LARGO / Lenght	
	2800	

REFERENCIA Reference	ANCHO Widht	CÓDIGO Code
Gris claro	279	82U0628
GRC-836 SOFT	349	82U0629
	430	82U0630
	449	82U0631
	630	82U0632
	699	82U0633
	730	82U0634
	830	82U0635
	899	82U0636
	930	82U0637
	1299	82U0638
	LARGO / Lenght	
	2800	

REFERENCIA Reference	ANCHO Widht	CÓDIGO Code
Roble nudos blanco	279	82U0408
HFX-176 RG	349	82U0409
	430	82U0410
	449	82U0411
	630	82U0412
	699	82U0413
	730	82U0414
	830	82U0415
	899	82U0416
	930	82U0417
	1299	82U0418
	LARGO / Lenght	
	2800	

REFERENCIA Reference	ANCHO Widht	CÓDIGO Code
Roble nudos natural	279	82U0419
HFX-180 RG	349	82U0420
	430	82U0421
	449	82U0422
	630	82U0423
	699	82U0424
	730	82U0425
	830	82U0426
	899	82U0427
	930	82U0428
	1299	82U0429
	LARGO / Lenght	
	2800	

REFERENCIA Reference	ANCHO Widht	CÓDIGO Code
Roble nudos tabaco	279	82U0430
HFX-181 RG	349	82U0431
	430	82U0432
	449	82U0433
	630	82U0434
	699	82U0435
	730	82U0436
	830	82U0437
	899	82U0438
	930	82U0439
	1299	82U0440
	LARGO / Lenght	
	2800	

REFERENCIA Reference	ANCHO Widht	CÓDIGO Code
Roble nudos zinc	279	82U0584
HFX-376 RG	349	82U0585
	430	82U0586
	449	82U0587
	630	82U0588
	699	82U0589
	730	82U0590
	830	82U0591
	899	82U0592
	930	82U0593
	1299	82U0594
	LARGO / Lenght	
	2800	

REFERENCIA Reference	ANCHO Widht	CÓDIGO Code
Roble café	279	82U0441
MES-799 V.V	349	82U0442
	430	82U0443
	449	82U0444
	630	82U0445
	699	82U0446
	730	82U0447
	830	82U0448
	899	82U0449
	930	82U0450
	1299	82U0451
	LARGO / Lenght	
	2800	

REFERENCIA Reference	ANCHO Widht	CÓDIGO Code
Roble claro	279	82U0342
OAC-809 PW	349	82U0343
	430	82U0344
	449	82U0345
	630	82U0346
	699	82U0347
	730	82U0348
	830	82U0349
	899	82U0350
	930	82U0351
	1299	82U0352
	LARGO / Lenght	
	2800	

REFERENCIA Reference	ANCHO Widht	CÓDIGO Code
Roble elegance	279	82U0375
OAD-822 FUN	349	82U0376
	430	82U0377
	449	82U0378
	630	82U0379
	699	82U0380
	730	82U0381
	830	82U0382
	899	82U0383
	930	82U0384
	1299	82U0385
	LARGO / Lenght	
	2800	

REFERENCIA Reference	ANCHO Widht	CÓDIGO Code
Roble avellana	279	82U0452
OAM-806 FUN	349	82U0453
	430	82U0454
	449	82U0455
	630	82U0456
	699	82U0457
	730	82U0458
	830	82U0459
	899	82U0460
	930	82U0461
	1299	82U0462
	LARGO / Lenght	
	2800	

REFERENCIA Reference	ANCHO Widht	CÓDIGO Code
Roble aneto	279	82U0353
OAN-807 FUN	349	82U0354
	430	82U0355
	449	82U0356
	630	82U0357
	699	82U0358
	730	82U0359
	830	82U0360
	899	82U0361
	930	82U0362
	1299	82U0363
	LARGO / Lenght	
	2850	

DISEÑOS BANDA INTEGRADA "U" 19 mm

19 mm designs "U" integrated bar

REFERENCIA Reference	ANCHO Widht	CÓDIGO Code
Roble tostado	279	82U0364
OAT-808 PW	349	82U0365
	430	82U0366
	449	82U0367
	630	82U0368
	699	82U0369
	730	82U0370
	830	82U0371
	899	82U0372
	930	82U0373
	1299	82U0374
	LARGO / Lenght	
	2800	

REFERENCIA Reference	ANCHO Widht	CÓDIGO Code
Olmo tostado	279	82U0463
PNH-003 RG	349	82U0464
	430	82U0465
	449	82U0466
	630	82U0467
	699	82U0468
	730	82U0469
	830	82U0470
	899	82U0471
	930	82U0472
	1299	82U0473
	LARGO / Lenght	
	2800	

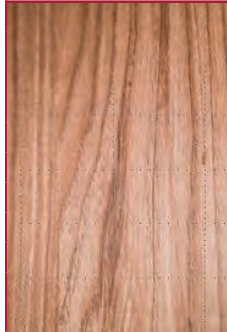
REFERENCIA Reference	ANCHO Widht	CÓDIGO Code
Olmo natural	279	82U0474
PNH-004 RG	349	82U0475
	430	82U0476
	449	82U0477
	630	82U0478
	699	82U0479
	730	82U0480
	830	82U0481
	899	82U0482
	930	82U0483
	1299	82U0484
	LARGO / Lenght	
	2800	

REFERENCIA Refece	ANCHO Widht	CÓDIGO Code
Rojo	279	82U0672
RED-840 SOFT	349	82U0673
	430	82U0674
	449	82U0675
	630	82U0676
	699	82U0677
	730	82U0678
	830	82U0679
	899	82U0680
	930	82U0681
	1299	82U0682
	LARGO / Lenght	
	2800	

REFERENCIA Reference	ANCHO Widht	CÓDIGO Code
Roble miel	279	82U0485
RHO-027 RG	349	82U0486
	430	82U0487
	449	82U0488
	630	82U0489
	699	82U0490
	730	82U0491
	830	82U0492
	899	82U0493
	930	82U0494
	1299	82U0495
	LARGO / Lenght	
	2800	

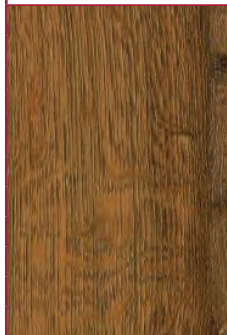
REFERENCIA Reference	ANCHO Widht	CÓDIGO Code
Roble coñac	279	82U0595
RSC-833 RG	349	82U0596
	430	82U0597
	449	82U0598
	630	82U0599
	699	82U0600
	730	82U0601
	830	82U0602
	899	82U0603
	930	82U0604
	1299	82U0605
	LARGO / Lenght	
	2800	

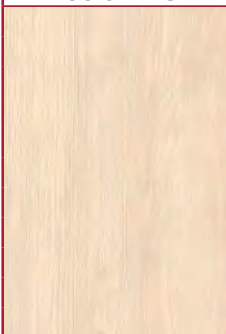
REFERENCIA Reference	ANCHO Widht	CÓDIGO Code
Roble azucar	279	82U0496
RSO-029 RG	349	82U0497
	430	82U0498
	449	82U0499
	630	82U0500
	699	82U0501
	730	82U0502
	830	82U0503
	899	82U0504
	930	82U0505
	1299	82U0506
	LARGO / Lenght	
	2800	

REFERENCIA Reference	ANCHO Widht	CÓDIGO Code
Teja	279	82U0617
RTE-835 SOFT	349	82U0618
	430	82U0619
	449	82U0620
	630	82U0621
	699	82U0622
	730	82U0623
	830	82U0624
	899	82U0625
	930	82U0626
	1299	82U0627
	LARGO / Lenght	
	2800	

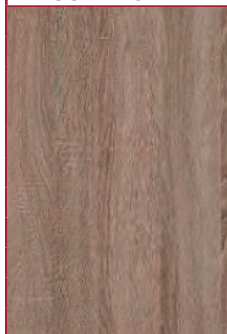
REFERENCIA Reference	ANCHO Widht	CÓDIGO Code
Roble tropical	279	82U0507
SON-798 V.V	349	82U0508
	430	82U0509
	449	82U0510
	630	82U0511
	699	82U0512
	730	82U0513
	830	82U0514
	899	82U0515
	930	82U0516
	1299	82U0517
	LARGO / Lenght	
	2800	

REFERENCIA Reference	ANCHO Widht	CÓDIGO Code
Nogal tostado	279	82U0540
TOS-824 RG	349	82U0541
	430	82U0542
	449	82U0543
	630	82U0544
	699	82U0545
	730	82U0546
	830	82U0547
	899	82U0548
	930	82U0549
	1299	82U0550
	LARGO / Lenght	
	3050	

DISEÑOS BANDA INTEGRADA "U" 22 mm

22 mm designs "U" integrated bar

REFERENCIA Reference	ANCHO Widht	CÓDIGO Code
Aguamarina AGM-834 SEF	279	82U0221
	349	82U0222
	430	82U0223
	449	82U0224
	630	82U0225
	699	82U0226
	730	82U0227
	830	82U0228
	899	82U0229
	930	82U0230
	1299	82U0231
	LARGO / Lenght	
	2800	

REFERENCIA Reference	ANCHO Widht	CÓDIGO Code
Arena ARB-810 SEF	279	82U0001
	349	82U0002
	430	82U0003
	449	82U0004
	630	82U0005
	699	82U0006
	730	82U0007
	830	82U0008
	899	82U0009
	930	82U0010
	1299	82U0011
	LARGO / Lenght	
	2800	

REFERENCIA Reference	ANCHO Widht	CÓDIGO Code
Arena claro ARC-837 SOFT	279	82U0254
	349	82U0255
	430	82U0256
	449	82U0257
	630	82U0258
	699	82U0259
	730	82U0260
	830	82U0261
	899	82U0262
	930	82U0263
	1299	82U0264
	LARGO / Lenght	
	2800	

REFERENCIA Reference	ANCHO Widht	CÓDIGO Code
Blanco fresno BLC-853 PF	279	82U0298
	349	82U0299
	430	82U0300
	449	82U0301
	630	82U0302
	699	82U0303
	730	82U0304
	830	82U0305
	899	82U0306
	930	82U0307
	1299	82U0308
	LARGO / Lenght	
	2800	

REFERENCIA Reference	ANCHO Widht	CÓDIGO Code
Blanco polar BLP-805 SEF	279	82U0309
	349	82U0310
	430	82U0311
	449	82U0312
	630	82U0313
	699	82U0314
	730	82U0315
	830	82U0316
	899	82U0317
	930	82U0318
	1299	82U0319
	LARGO / Lenght	
	2800	

REFERENCIA Reference	ANCHO Widht	CÓDIGO Code
Cacao chocolate CAC-839 SOFT	279	82U0276
	349	82U0277
	430	82U0278
	449	82U0279
	630	82U0280
	699	82U0281
	730	82U0282
	830	82U0283
	899	82U0284
	930	82U0285
	1299	82U0286
	LARGO / Lenght	
	2800	

REFERENCIA Reference	ANCHO Widht	CÓDIGO Code
Nogal rústico CLC-828 SYNCH	279	82U0177
	349	82U0178
	430	82U0179
	449	82U0180
	630	82U0181
	699	82U0182
	730	82U0183
	830	82U0184
	899	82U0185
	930	82U0186
	1299	82U0187
	LARGO / Lenght	
	3050	

REFERENCIA Reference	ANCHO Widht	CÓDIGO Code
Nogal alfil CLN-829 SYNCH	279	82U0188
	349	82U0189
	430	82U0190
	449	82U0191
	630	82U0192
	699	82U0193
	730	82U0194
	830	82U0195
	899	82U0196
	930	82U0197
	1299	82U0198
	LARGO / Lenght	
	3050	

REFERENCIA Reference	ANCHO Widht	CÓDIGO Code
Nogal pacífico CLO-826 SYNCH	279	82U0166
	349	82U0167
	430	82U0168
	449	82U0169
	630	82U0170
	699	82U0171
	730	82U0172
	830	82U0173
	899	82U0174
	930	82U0175
	1299	82U0176
	LARGO / Lenght	
	3050	

REFERENCIA Reference	ANCHO Widht	CÓDIGO Code
Nogal negro ENC-821 SPIRIT	279	82U0133
	349	82U0134
	430	82U0135
	449	82U0136
	630	82U0137
	699	82U0138
	730	82U0139
	830	82U0140
	899	82U0141
	930	82U0142
	1299	82U0143
	LARGO / Lenght	
	2800	

REFERENCIA Reference	ANCHO Widht	CÓDIGO Code
Nogal italiano EXP-823 SPIRIT	279	82U0144
	349	82U0145
	430	82U0146
	449	82U0147
	630	82U0148
	699	82U0149
	730	82U0150
	830	82U0151
	899	82U0152
	930	82U0153
	1299	82U0154
	LARGO / Lenght	
	2800	

REFERENCIA Reference	ANCHO Widht	CÓDIGO Code
Gris antacita GAN-811 SEF	279	82U0012
	349	82U0013
	430	82U0014
	449	82U0015
	630	82U0016
	699	82U0017
	730	82U0018
	830	82U0019
	899	82U0020
	930	82U0021
	1299	82U0022
	LARGO / Lenght	
	2800	

DISEÑOS BANDA INTEGRADA "U" 22 mm

22 mm designs "U" integrated bar

REFERENCIA Reference	ANCHO Widht	CÓDIGO Code	
Negro GLP-283 SOFT	279	82U0265	
	349	82U0266	
	430	82U0267	
	449	82U0268	
	630	82U0269	
	699	82U0270	
	730	82U0271	
	830	82U0272	
	899	82U0273	
	930	82U0274	
	1299	82U0275	
	LARGO / Lenght		2800

REFERENCIA Reference	ANCHO Widht	CÓDIGO Code	
Gris claro GRC-836 SOFT	279	82U0243	
	349	82U0244	
	430	82U0245	
	449	82U0246	
	630	82U0247	
	699	82U0248	
	730	82U0249	
	830	82U0250	
	899	82U0251	
	930	82U0252	
	1299	82U0253	
	LARGO / Lenght		2800

REFERENCIA Reference	ANCHO Widht	CÓDIGO Code	
Roble nudos blanco HFX-176 RG	279	82U0023	
	349	82U0024	
	430	82U0025	
	449	82U0026	
	630	82U0027	
	699	82U0028	
	730	82U0029	
	830	82U0030	
	899	82U0031	
	930	82U0032	
	1299	82U0033	
	LARGO / Lenght		2800

REFERENCIA Reference	ANCHO Widht	CÓDIGO Code	
Roble nudos natural HFX-180 RG	279	82U0034	
	349	82U0035	
	430	82U0036	
	449	82U0037	
	630	82U0038	
	699	82U0039	
	730	82U0040	
	830	82U0041	
	899	82U0042	
	930	82U0043	
	1299	82U0044	
	LARGO / Lenght		2800

REFERENCIA Reference	ANCHO Widht	CÓDIGO Code	
Roble nudos tabaco HFX-181 RG	279	82U0045	
	349	82U0046	
	430	82U0047	
	449	82U0048	
	630	82U0049	
	699	82U0050	
	730	82U0051	
	830	82U0052	
	899	82U0053	
	930	82U0054	
	1299	82U0055	
	LARGO / Lenght		2800

REFERENCIA Reference	ANCHO Widht	CÓDIGO Code	
Roble nudos zinc HFX-376 RG	279	82U0199	
	349	82U0200	
	430	82U0201	
	449	82U0202	
	630	82U0203	
	699	82U0204	
	730	82U0205	
	830	82U0206	
	899	82U0207	
	930	82U0208	
	1299	82U0209	
	LARGO / Lenght		2800

REFERENCIA Reference	ANCHO Widht	CÓDIGO Code	
Roble café MES-799 V.V	279	82U0056	
	349	82U0057	
	430	82U0058	
	449	82U0059	
	630	82U0060	
	699	82U0061	
	730	82U0062	
	830	82U0063	
	899	82U0064	
	930	82U0065	
	1299	82U0066	
	LARGO / Lenght		2800

REFERENCIA Reference	ANCHO Widht	CÓDIGO Code	
Roble avellana OAM-806 FUN	279	82U0067	
	349	82U0068	
	430	82U0069	
	449	82U0070	
	630	82U0071	
	699	82U0072	
	730	82U0073	
	830	82U0074	
	899	82U0075	
	930	82U0076	
	1299	82U0077	
	LARGO / Lenght		2800

REFERENCIA Reference	ANCHO Widht	CÓDIGO Code	
Olmo tostado PNH-003 RG	279	82U0078	
	349	82U0079	
	430	82U0080	
	449	82U0081	
	630	82U0082	
	699	82U0083	
	730	82U0084	
	830	82U0085	
	899	82U0086	
	930	82U0087	
	1299	82U0088	
	LARGO / Lenght		2800

REFERENCIA Reference	ANCHO Widht	CÓDIGO Code	
Olmo natural PNH-004 RG	279	82U0089	
	349	82U0090	
	430	82U0091	
	449	82U0092	
	630	82U0093	
	699	82U0094	
	730	82U0095	
	830	82U0096	
	899	82U0097	
	930	82U0098	
	1299	82U0099	
	LARGO / Lenght		2800

REFERENCIA Reference	ANCHO Widht	CÓDIGO Code	
Rojo RED-840 SOFT	279	82U0287	
	349	82U0288	
	430	82U0289	
	449	82U0290	
	630	82U0291	
	699	82U0292	
	730	82U0293	
	830	82U0294	
	899	82U0295	
	930	82U0296	
	1299	82U0297	
	LARGO / Lenght		2800

REFERENCIA Reference	ANCHO Widht	CÓDIGO Code	
Roble miel RHO-027 RG	279	82U0100	
	349	82U0101	
	430	82U0102	
	449	82U0103	
	630	82U0104	
	699	82U0105	
	730	82U0106	
	830	82U0107	
	899	82U0108	
	930	82U0109	
	1299	82U0110	
	LARGO / Lenght		2800

DISEÑOS BANDA INTEGRADA "U" 22 mm

22 mm designs "U" integrated bar

REFERENCIA Reference	ANCHO Widht	CÓDIGO Code
Roble coñac RSC-833 RG 	279	82U0210
	349	82U0211
	430	82U0212
	449	82U0213
	630	82U0214
	699	82U0215
	730	82U0216
	830	82U0217
	899	82U0218
	930	82U0219
	1299	82U0220
	LARGO / Lenght	

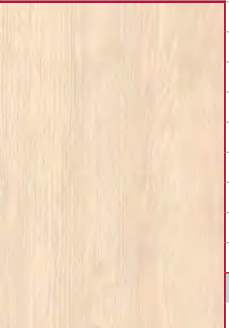
REFERENCIA Reference	ANCHO Widht	CÓDIGO Code
Roble azucar RSO-029 RG 	279	82U0111
	349	82U0112
	430	82U0113
	449	82U0114
	630	82U0115
	699	82U0116
	730	82U0117
	830	82U0118
	899	82U0119
	930	82U0120
	1299	82U0121
	LARGO / Lenght	

REFERENCIA Reference	ANCHO Widht	CÓDIGO Code
Teja RTE-835 SOFT 	279	82U0232
	349	82U0233
	430	82U0234
	449	82U0235
	630	82U0236
	699	82U0237
	730	82U0238
	830	82U0239
	899	82U0240
	930	82U0241
	1299	82U0242
	LARGO / Lenght	

REFERENCIA Reference	ANCHO Widht	CÓDIGO Code
Roble tropical SON-798 V.V 	279	82U0122
	349	82U0123
	430	82U0124
	449	82U0125
	630	82U0126
	699	82U0127
	730	82U0128
	830	82U0129
	899	82U0130
	930	82U0131
	1299	82U0132
	LARGO / Lenght	

REFERENCIA Reference	ANCHO Widht	CÓDIGO Code
Nogal tostado TOS-824 RG 	279	82U0155
	349	82U0156
	430	82U0157
	449	82U0158
	630	82U0159
	699	82U0160
	730	82U0161
	830	82U0162
	899	82U0163
	930	82U0164
	1299	82U0165
	LARGO / Lenght	

BANDA POSTFORMADA

Postformed bar

■ **CARACTERÍSTICAS TÉCNICAS:**

Terminacion: postformado con radio 4 mm.
 Soporte: tablero aglomerado.
 Recubrimiento: melamina decorativa acabada en mate y film protector.
 Contracara: similar acabado soft.
 Adhesivo: resina melaminica.
 Espesor: 19 mm.

■ **FEATURES:**

Finish: 4 mm radius postformed.
 Core: particle board.
 Covering: decorative melamine matt finish with and protective film.
 Backside: similar colour soft finish.
 Adhesive: melamine resin.
 Thickness: 19 mm.

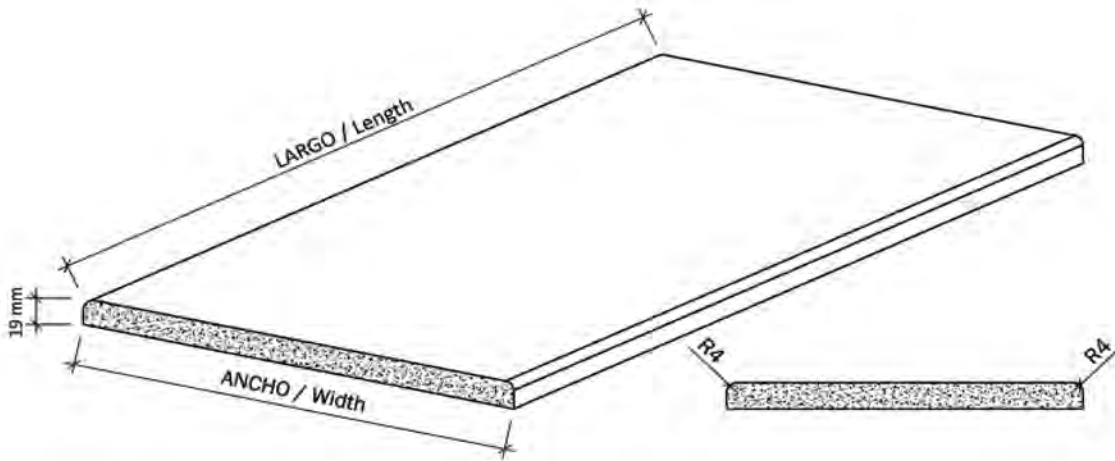

■ **CARACTERÍSTICAS TÉCNICAS:**

- Paquete estándar 10 unidades por medida y diseño.
- Por unidad, consultar condiciones.

■ **FEATURES:**

- Standard package 10 units per measurement and design.
- Per unit, ask about conditions.

MEDIDAS Y PESOS Dimensions and weights	
LARGO X ANCHO Length x width	PESO BANDA Bar weight
2850x147x19 mm	5,85 kg
2850x247x19 mm	9,70 kg.
2850x297x19 mm	11,65 kg.
2850x347x19 mm	13,60 kg.
2850x397x19 mm	15,50 kg.
2850x447x19 mm	17,45 kg.
2850x497x19 mm	19,40 kg.
2850x597x19 mm	23,25 kg.
2850x697x19 mm	27,20 kg.
2850x897x19 mm	34,90 kg.

Dimensiones según diseño.
 Dimensions according to design.

DISEÑOS BANDA POSTFORMADA 19 mm

19 mm designs postformed bar

REFERENCIA <i>Reference</i>	ANCHO <i>Widht</i>	CÓDIGO <i>Code</i>
Blanco polar BLP-805 SEF	147	8802675
	247	8802676
	297	8802677
	347	8802678
	397	8802679
	447	8802680
	497	8802681
	597	8802682
	697	8802683
	897	8802684
	LARGO / <i>Lenght</i>	
2850		

B.

extreme hpl



TOP FORM

TABLERO

Board

■ CARACTERÍSTICAS TÉCNICAS:

Terminación: en recto.

Soporte: tablero aglomerado.

Recubrimiento: laminado decorativo HPL de 0,7 mm de espesor y film protector.

Contracara: idem, mismo color.

Adhesivo: cola PUR, poliuretano reactivo prensado en frío.

Espesor: 19 mm más laminado.

■ FEATURES:

Finish in straight.

Core: particle board.

Covering: 0.7 mm thick decorative HPL laminate and protective film.

Backside: Idem, same colour.

Adhesive: old press reactive polyurethane (PUR) glue.

Thickness: 19 mm plus laminate.

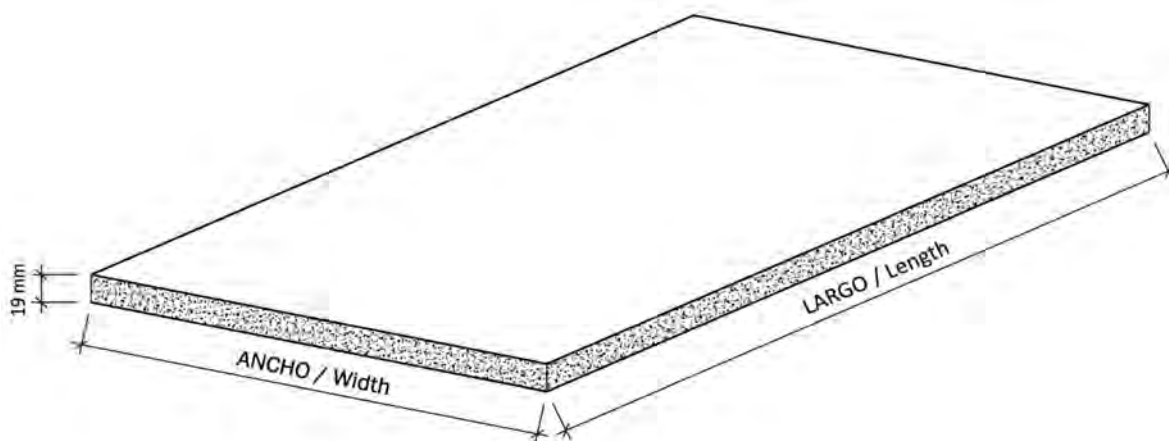
**■ CARACTERÍSTICAS TÉCNICAS:**

- Paquete estándar 10 unidades por medida y diseño.
- Por unidad, consultar condiciones.

■ FEATURES:

- Standard package 10 units per measurement and design.
- Per unit, ask about conditions.

MEDIDAS Y PESOS Dimensions and weights	
LARGO X ANCHO Length x width	PESO TABLERO Board weight
3600x1380x19 mm.	69,75 kg.
3600x1510x19 mm.	75,40 kg.

Dimensiones según diseño.

Dimensions according to design.

DISEÑOS TABLERO 19 mm

19 mm Designs board

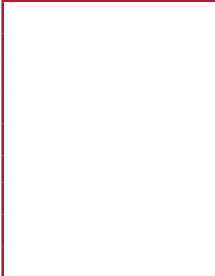
	REFERENCIA <i>Reference</i>
	Blanco 3091 BRILLO
	MEDIDA <i>Measure</i>
	3600x1510x19
CÓDIGO / <i>Code</i>	
3301177	

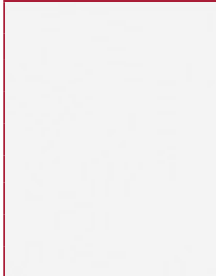
	REFERENCIA <i>Reference</i>
	Blanco Islandia 3091 SEF
	MEDIDA <i>Measure</i>
	3600x1380x19
CÓDIGO / <i>Code</i>	
3301735	

	REFERENCIA <i>Reference</i>
	Pistacho COV-222 BRILLO
	MEDIDA <i>Measure</i>
	3600x1510x19
CÓDIGO / <i>Code</i>	
3300687	

	REFERENCIA <i>Reference</i>
	Burdeos GLB-247 BRILLO
	MEDIDA <i>Measure</i>
	3600x1510x19
CÓDIGO / <i>Code</i>	
3300543	

	REFERENCIA <i>Reference</i>
	Crema Suave GLC-158 BRILLO
	MEDIDA <i>Measure</i>
	3600x1380x19
CÓDIGO / <i>Code</i>	
3301549	

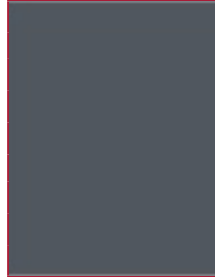
	REFERENCIA <i>Reference</i>
	Gris GLG-400 BRILLO
	MEDIDA <i>Measure</i>
	3600x1510x19
CÓDIGO / <i>Code</i>	
3300562	

	REFERENCIA <i>Reference</i>
	Aluminio GLI-159 BRILLO
	MEDIDA <i>Measure</i>
	3600x1380x19
CÓDIGO / <i>Code</i>	
3301618	

	REFERENCIA <i>Reference</i>
	Berenjena GLK-401 BRILLO
	MEDIDA <i>Measure</i>
	3600x1380x19
CÓDIGO / <i>Code</i>	
3301620	

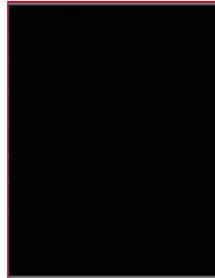
	REFERENCIA <i>Reference</i>
	Negro GLP-283 BRILLO
	MEDIDA <i>Measure</i>
	3600x1510x19
CÓDIGO / <i>Code</i>	
3300547	

	REFERENCIA <i>Reference</i>
	Rojo escarlata GLR-244 BRILLO
	MEDIDA <i>Measure</i>
	3600x1380x19
CÓDIGO / <i>Code</i>	
3302180	

	REFERENCIA <i>Reference</i>
	Café GLS-248 BRILLO
	MEDIDA <i>Measure</i>
	3600x1380x19
CÓDIGO / <i>Code</i>	
3300573	

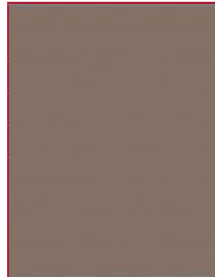
	REFERENCIA <i>Reference</i>
	Cacao maní INA-814 NDF
	MEDIDA <i>Measure</i>
	3600x1380x19
CÓDIGO / <i>Code</i>	
3303679	

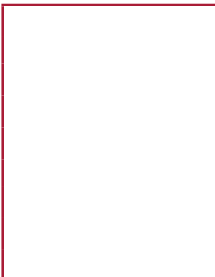
	REFERENCIA <i>Reference</i>
	Blanco Groenlandia INB-812 NDF
	MEDIDA <i>Measure</i>
	3600x1380x19
CÓDIGO / <i>Code</i>	
3301514	

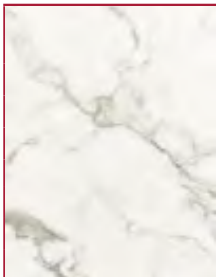
	REFERENCIA <i>Reference</i>
	Calacatta INC-818 NDF
	MEDIDA <i>Measure</i>
	3600x1380x19
CÓDIGO / <i>Code</i>	
3303683	

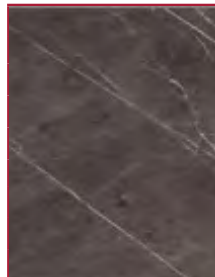
	REFERENCIA <i>Reference</i>
	Marquina gris INM-817 NDF
	MEDIDA <i>Measure</i>
	3600x1380x19
CÓDIGO / <i>Code</i>	
3303682	

	REFERENCIA <i>Reference</i>
	Negro profundo INN-816 NDF
	MEDIDA <i>Measure</i>
	3600x1380x19
CÓDIGO / <i>Code</i>	
3303681	

	REFERENCIA <i>Reference</i>
	Café mokachino INP-813 NDF
	MEDIDA <i>Measure</i>
	3600x1380x19
CÓDIGO / <i>Code</i>	
3302293	

	REFERENCIA <i>Reference</i>
	Grafito INT-815 NDF
	MEDIDA <i>Measure</i>
	3600x1380x19
CÓDIGO / <i>Code</i>	
3303680	

DISEÑOS TABLERO 19 mm

19 mm Designs board

	REFERENCIA <i>Reference</i>
	Talco LAR-770 SOFT
	MEDIDA <i>Measure</i>
	3600x1510x19
CÓDIGO / <i>Code</i>	
3301704	

	REFERENCIA <i>Reference</i>
	Mármol marquina MAC-820 STUCCO
	MEDIDA <i>Measure</i>
	3600x1380x19
CÓDIGO / <i>Code</i>	
3302107	

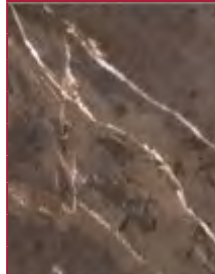
	REFERENCIA <i>Reference</i>
	Mármol emperador MAY-819 STUCCO
	MEDIDA <i>Measure</i>
	3600x1380x19
CÓDIGO / <i>Code</i>	
3302106	

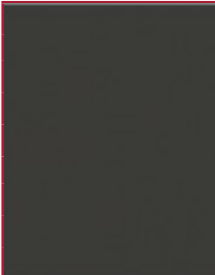
	REFERENCIA <i>Reference</i>
	Gris metálico MTG-765 BRILLO
	MEDIDA <i>Measure</i>
	3600x1380x19
CÓDIGO / <i>Code</i>	
3301630	

	REFERENCIA <i>Reference</i>
	Óxido azul OXA-445 WAX
	MEDIDA <i>Measure</i>
	3600x1380x19
CÓDIGO / <i>Code</i>	
3301761	

	REFERENCIA <i>Reference</i>
	Óxido marrón OXM-444 WAX
	MEDIDA <i>Measure</i>
	3600x1380x19
CÓDIGO / <i>Code</i>	
3301703	

	REFERENCIA <i>Reference</i>
	Pino kenia PIR-022 SOFT
	MEDIDA <i>Measure</i>
	3600x1380x19
CÓDIGO / <i>Code</i>	
3301945	

	REFERENCIA <i>Reference</i>
	Pino viejo PIV-023 SOFT
	MEDIDA <i>Measure</i>
	3600x1380x19
CÓDIGO / <i>Code</i>	
3301499	

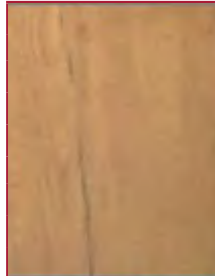
	REFERENCIA <i>Reference</i>
	Roble natural RON-803 OP
	MEDIDA <i>Measure</i>
	3600x1510x19
CÓDIGO / <i>Code</i>	
3302230	

	REFERENCIA <i>Reference</i>
	Cemento TRC-443 WAX
	MEDIDA <i>Measure</i>
	3600x1380x19
CÓDIGO / <i>Code</i>	
3301702	

BANDA POSTFORMADA

Postformed bar

■ **CARACTERÍSTICAS TÉCNICAS:**

Terminacion: postformado con radio 2 mm.
 Soporte: tablero aglomerado.
 Recubrimiento: laminado decorativo HPL de 0,7 mm de espesor y film protector.
 Contracara: idem, mismo color.
 Adhesivo: cola PUR, poliuretano reactivo prensado en frío.
 Espesor: 19 mm más laminado.

■ **FEATURES:**

Finish: 2 mm radius postformed.
 Core: particle board.
 Covering: 0.7 mm thick decorative HPL laminate and protective film.
 Backside: Idem, same colour.
 Adhesive: old press reactive polyurethane (PUR) glue.
 Thickness: 19 mm plus laminate.

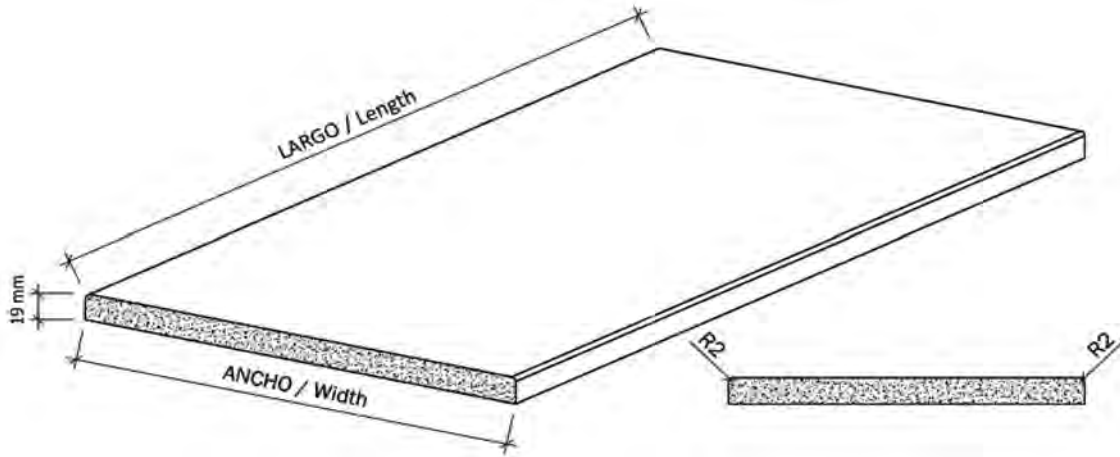

■ **CARACTERÍSTICAS TÉCNICAS:**

- Paquete estándar 10 unidades por medida y diseño.
- Por unidad, consultar condiciones.

■ **FEATURES:**

- Standard package 10 units per measurement and design.
- Per unit, ask about conditions.

MEDIDAS Y PESOS Dimensions and weights	
LARGO X ANCHO Length x width	PESO BANDA Bar weight
3600x147x19 mm	8,45 kg.
3600x247x19 mm	13,61 kg.
3600x297x19 mm	16,08 kg.
3600x347x19 mm	18,55 kg.
3600x397x19 mm	21,25 kg.
3600x447x19 mm	23,71 kg.
3600x497x19 mm	26,18 kg.
3600x597x19 mm	31,34 kg.
3600x697x19 mm	36,28 kg.
3600x897x19 mm	46,37 kg.

Dimensiones según diseño.
 Dimensions according to design.

DISEÑOS BANDA POSTFORMADA 19 mm

19 mm designs postformed bar

REFERENCIA Reference	ANCHO Widht	CÓDIGO Code
Blanco 3091 BRILLO	147	2301338
	247	2301340
	297	2301341
	347	2301342
	397	2301343
	447	2301344
	497	2301345
	597	2301346
	697	2301347
	897	2301350
LARGO / Lenght		
3600		

REFERENCIA Reference	ANCHO Widht	CÓDIGO Code
Blanco Islandia 3091 SEF	147	2301989
	247	2301991
	297	2301992
	347	2301993
	397	2301994
	447	2301995
	497	2301996
	597	2301997
	697	2301998
	897	2301999
LARGO / Lenght		
3600		

C.



TOP FORM

TABLERO

Board

■ CARACTERÍSTICAS TÉCNICAS:

Terminación: en recto.

Soporte: tablero aglomerado.

Recubrimiento: capa melamínica interna prensada, más laminado sintético PET/TSL externo acabado en súper brillo o súper mate (SP) y film protector.

Contracara: simil.

Adhesivo: cola PUR (poliuretano reactivo prensado en frío).

Espesor: 19 mm.

■ FEATURES:

Finish in straight.

Core: particle board.

Covering: internal melaminica cape press plus synthetic decorative laminate PET/TSL finish super-shiny or super-matte (SP) and protective film.

Backside: similar

Adhesive: PUR glue (old press reactive polyurethane).

Thickness: 19 mm.

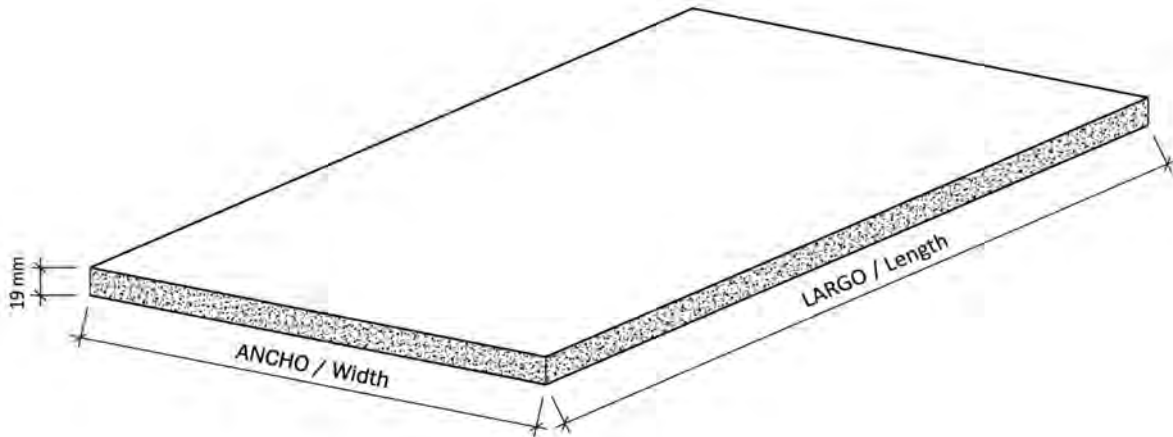
**■ CARACTERÍSTICAS TÉCNICAS:**

- Paquete estándar 15 unidades por medida y diseño.
- Por unidad, consultar condiciones.

■ FEATURES:

- Standard package 15 units per measurement and design.
- Per unit, ask about conditions.

MEDIDAS Y PESOS Dimensions and weights	
LARGO X ANCHO Length x width	PESO TABLERO Board weight
2800x730x19 mm.	26,40 kg.
2800x1310x19 mm.	47,40 kg.
2850x1220x19 mm.	45,00 kg.

Dimensiones según diseño.

Dimensions according to design.

DISEÑOS TABLERO 19 mm

19 mm Designs board

	REFERENCIA <i>Reference</i>
	Blanco Finlandia PEB-070 BRILLO
	MEDIDA <i>Measure</i>
	2850x1220x19
CÓDIGO / <i>Code</i>	
4800864	

	REFERENCIA <i>Reference</i>
	Crema PEB-071 BRILLO
	MEDIDA <i>Measure</i>
	2850x1220x19
CÓDIGO / <i>Code</i>	
4800865	

	REFERENCIA <i>Reference</i>
	Lava PEB-072 BRILLO
	MEDIDA <i>Measure</i>
	2850x1220x19
CÓDIGO / <i>Code</i>	
4800866	

	REFERENCIA <i>Reference</i>
	Gris oscuro PEB-073 BRILLO
	MEDIDA <i>Measure</i>
	2850x1220x19
CÓDIGO / <i>Code</i>	
4800867	

	REFERENCIA <i>Reference</i>
	Rojo cherry PEB-077 BRILLO
	MEDIDA <i>Measure</i>
	2850x1220x19
CÓDIGO / <i>Code</i>	
4800868	

	REFERENCIA <i>Reference</i>
	Negro Madagascar PEB-078 BRILLO
	MEDIDA <i>Measure</i>
	2850x1220x19
CÓDIGO / <i>Code</i>	
4800869	

	REFERENCIA <i>Reference</i>
	Café Latte PEB-080 BRILLO
	MEDIDA <i>Measure</i>
	2850x1220x19
CÓDIGO / <i>Code</i>	
4800870	

	REFERENCIA <i>Reference</i>
	Ceniza PEB-081 BRILLO
	MEDIDA <i>Measure</i>
	2850x1220x19
CÓDIGO / <i>Code</i>	
4800871	

	REFERENCIA <i>Reference</i>
	Burdeos teja PEB-085 BRILLO
	MEDIDA <i>Measure</i>
	2850x1220x19
CÓDIGO / <i>Code</i>	
4800872	

	REFERENCIA <i>Reference</i>
	Aguamarina urban PEB-086 BRILLO
	MEDIDA <i>Measure</i>
	2850x1220x19
CÓDIGO / <i>Code</i>	
4800873	

	REFERENCIA <i>Reference</i>
	Roble claro OAC-809 BRILLO
	MEDIDA <i>Measure</i>
	2800x1310+730x19
CÓDIGO / <i>Code</i>	
P49OAC809HG19	

	REFERENCIA <i>Reference</i>
	Roble elegance OAD-822 BRILLO
	MEDIDA <i>Measure</i>
	2800x1310+730x19
CÓDIGO / <i>Code</i>	
P49OAD822HG19	

	REFERENCIA <i>Reference</i>
	Roble avellana OAM-806 BRILLO
	MEDIDA <i>Measure</i>
	2800x1310+730x19
CÓDIGO / <i>Code</i>	
P49OAM806HG19	

	REFERENCIA <i>Reference</i>
	Roble aneto OAN-807 BRILLO
	MEDIDA <i>Measure</i>
	2800x1310+730x19
CÓDIGO / <i>Code</i>	
P49OAN807HG19	

	REFERENCIA <i>Reference</i>
	Roble tostado OAT-808 BRILLO
	MEDIDA <i>Measure</i>
	2800x1310+730x19
CÓDIGO / <i>Code</i>	
P49OAT808HG19	

	REFERENCIA <i>Reference</i>
	Aguamarina urban PEM-051 SP
	MEDIDA <i>Measure</i>
	2850x1220x19
CÓDIGO / <i>Code</i>	
4800855	

	REFERENCIA <i>Reference</i>
	Burdeos teja PEM-052 SP
	MEDIDA <i>Measure</i>
	2850x1220x19
CÓDIGO / <i>Code</i>	
4800856	

	REFERENCIA <i>Reference</i>
	Cacao PEM-055 SP
	MEDIDA <i>Measure</i>
	2850x1220x19
CÓDIGO / <i>Code</i>	
4800874	

DISEÑOS TABLERO 19 mm

19 mm Designs board

	REFERENCIA Reference
	Ceniza PEM-056 SP
	MEDIDA Measure
	2850x1220x19
	CÓDIGO / Code 4800875

	REFERENCIA Reference
	Gris oscuro PEM-057 SP
	MEDIDA Measure
	2850x1220x19
	CÓDIGO / Code 4800876

	REFERENCIA Reference
	Café Latte PEM-058 SP
	MEDIDA Measure
	2850x1220x19
	CÓDIGO / Code 4800877

	REFERENCIA Reference
	Blanco Finlandia PEM-060 SP
	MEDIDA Measure
	2850x1220x19
	CÓDIGO / Code 4800604

	REFERENCIA Reference
	Capuchino PEM-061 SP
	MEDIDA Measure
	2850x1220x19
	CÓDIGO / Code 4800878

	REFERENCIA Reference
	Rojo cherry PEM-063 SP
	MEDIDA Measure
	2850x1220x19
	CÓDIGO / Code 4800879

	REFERENCIA Reference
	Negro Madagascar PEM-064 SP
	MEDIDA Measure
	2850x1220x19
	CÓDIGO / Code 4800880

	REFERENCIA Reference
	Roble claro OAC-809 SP
	MEDIDA Measure
	2800x1310+730x19
	CÓDIGO / Code P49OAC809SM19

	REFERENCIA Reference
	Roble elegance OAD-822 SP
	MEDIDA Measure
	2800x1310+730x19
	CÓDIGO / Code P49OAD822SM19

	REFERENCIA Reference
	Roble avellana OAM-806 SP
	MEDIDA Measure
	2800x1310+730x19
	CÓDIGO / Code P49OAM806SM19

	REFERENCIA Reference
	Roble aneto OAN-807 SP
	MEDIDA Measure
	2800x1310+730x19
	CÓDIGO / Code P49OAN807SM19

	REFERENCIA Reference
	Roble tostado OAT-808 SP
	MEDIDA Measure
	2800x1310+730x19
	CÓDIGO / Code P49OAT808SM19

	REFERENCIA Reference
	Blanco Suecia PER-001 GRAIN
	MEDIDA Measure
	2850x1220x19
	CÓDIGO / Code 4800857

	REFERENCIA Reference
	Arena Sahara PER-002 GRAIN
	MEDIDA Measure
	2850x1220x19
	CÓDIGO / Code 4800858

	REFERENCIA Reference
	Gris Londres PER-003 GRAIN
	MEDIDA Measure
	2850x1220x19
	CÓDIGO / Code 4800859

	REFERENCIA Reference
	Bronce PEW-100 METALLIC
	MEDIDA Measure
	2850x1220x19
	CÓDIGO / Code 4800881

BANDA INTEGRADA "J"

"J" Integrated bar

■ CARACTERÍSTICAS TÉCNICAS:

Terminación: perfil tirador postformado tipo "J".
 Soporte: tablero aglomerado.
 Recubrimiento: capa melaminica interna prensada, más laminado sintético PET/TSL externo acabado en súper mate (SP) y film protector.
 Contracara: simil.
 Adhesivo: cola PUR (poliuretano reactivo prensado en frio).
 Espesor: 19 mm.



■ FEATURES:

Finish: profile handle postforming type "J"
 Core: particle board.
 Covering: internal melaminica cape press plus synthetic decorative laminate PET/TSL finish super-matte (SP) and protective film.
 Backside: similar
 Adhesive: PUR glue (old press reactive polyurethane).
 Thickness: 19 mm.

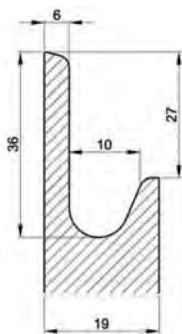
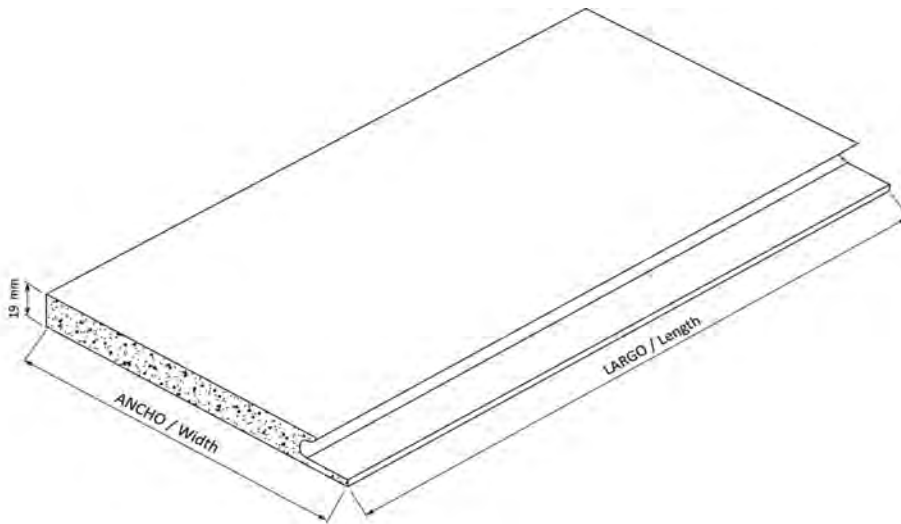

■ CARACTERÍSTICAS TÉCNICAS:

- Paquete estándar 15 unidades por medida y diseño.
- Por unidad, consultar condiciones.

■ FEATURES:

- Standard package 15 units per measurement and design.
- Per unit, ask about conditions.

MEDIDAS Y PESOS Dimensions and weights	
LARGO X ANCHO Length x width	PESO BANDA Bar weight
2850x279x19 mm.	10,31 kg.
2850x349x19 mm.	12,89 kg.
2850x430x19 mm.	15,83 kg.
2850x449x19 mm.	16,57 kg.
2850x630x19 mm.	22,95 kg.
2850x699x19 mm.	25,77 kg.
2850x730x19 mm.	26,88 kg.
2850x830x19 mm.	30,56 kg.
2850x899x19 mm.	33,14 kg.
2850x930x19 mm.	32,24 kg.
2850x1185x19 mm.	43,18 kg.
2800x1299x19 mm.	47,03 kg.

Dimensiones según diseño.
 Dimensions according to design.

DISEÑOS BANDA INTEGRADA "J" 19 mm

19 mm designs "J" integrated bar

REFERENCIA Reference	ANCHO Widht	CÓDIGO Code
Aguamarina urban PEM-051 SP 	279	81J0906
	349	81J0907
	430	81J0908
	449	81J0909
	630	81J0910
	699	81J0911
	730	81J0912
	830	81J0913
	899	81J0914
	930	81J0915
	1185	81J0916
	LARGO / Lenght	

REFERENCIA Reference	ANCHO Widht	CÓDIGO Code
Burdeos teja PEM-052 SP 	279	81J0917
	349	81J0918
	430	81J0919
	449	81J0920
	630	81J0921
	699	81J0922
	730	81J0923
	830	81J0924
	899	81J0925
	930	81J0926
	1185	81J0927
	LARGO / Lenght	

REFERENCIA Reference	ANCHO Widht	CÓDIGO Code
Cacao PEM-055 SP 	279	81J0928
	349	81J0929
	430	81J0930
	449	81J0931
	630	81J0932
	699	81J0933
	730	81J0934
	830	81J0935
	899	81J0936
	930	81J0937
	1299	81J1095
	LARGO / Lenght	

REFERENCIA Reference	ANCHO Widht	CÓDIGO Code
Ceniza PEM-056 SP 	279	81J0939
	349	81J0940
	430	81J0941
	449	81J0942
	630	81J0943
	699	81J0944
	730	81J0945
	830	81J0946
	899	81J0947
	930	81J0948
	1299	81J1096
	LARGO / Lenght	

REFERENCIA Reference	ANCHO Widht	CÓDIGO Code
Gris oscuro PEM-057 SP 	279	81J0950
	349	81J0951
	430	81J0952
	449	81J0953
	630	81J0954
	699	81J0955
	730	81J0956
	830	81J0957
	899	81J0958
	930	81J0959
	1299	81J1097
	LARGO / Lenght	

REFERENCIA Reference	ANCHO Widht	CÓDIGO Code
Café Latte PEM-058 SP 	279	81J0961
	349	81J0962
	430	81J0963
	449	81J0964
	630	81J0965
	699	81J0966
	730	81J0967
	830	81J0968
	899	81J0969
	930	81J0970
	1299	81J1098
	LARGO / Lenght	

REFERENCIA Reference	ANCHO Widht	CÓDIGO Code
Blanco Finlandia PEM-060 SP 	279	81J0972
	349	81J0973
	430	81J0974
	449	81J0975
	630	81J0976
	699	81J0977
	730	81J0978
	830	81J0979
	899	81J0980
	930	81J0981
	1299	81J1099
	LARGO / Lenght	

REFERENCIA Reference	ANCHO Widht	CÓDIGO Code
Capuchino PEM-061 SP 	279	81J0983
	349	81J0984
	430	81J0985
	449	81J0986
	630	81J0987
	699	81J0988
	730	81J0989
	830	81J0990
	899	81J0991
	930	81J0992
	1299	81J1100
	LARGO / Lenght	

REFERENCIA Reference	ANCHO Widht	CÓDIGO Code
Rojo cherry PEM-063 SP 	279	81J0994
	349	81J0995
	430	81J0996
	449	81J0997
	630	81J0998
	699	81J0999
	730	81J1000
	830	81J1001
	899	81J1002
	930	81J1003
	1299	81J1101
	LARGO / Lenght	

REFERENCIA Reference	ANCHO Widht	CÓDIGO Code
Negro Madagascar PEM-064 SP 	279	81J1005
	349	81J1006
	430	81J1007
	449	81J1008
	630	81J1009
	699	81J1010
	730	81J1011
	830	81J1012
	899	81J1013
	930	81J1014
	1299	81J1102
	LARGO / Lenght	

REFERENCIA Reference	ANCHO Widht	CÓDIGO Code
Roble claro OAC-809 SP 	279	81J1049
	349	81J1050
	430	81J1051
	449	81J1052
	630	81J1053
	699	81J1054
	730	81J1055
	830	81J1056
	899	81J1057
	930	81J1058
	1299	81J1059
	LARGO / Lenght	

REFERENCIA Reference	ANCHO Widht	CÓDIGO Code
Roble elegance OAD-822 SP 	279	81J1060
	349	81J1061
	430	81J1062
	449	81J1063
	630	81J1064
	699	81J1065
	730	81J1066
	830	81J1067
	899	81J1068
	930	81J1069
	1299	81J1070
	LARGO / Lenght	

DISEÑOS BANDA INTEGRADA "J" 19 mm

19 mm designs "J" integrated bar

REFERENCIA Reference	ANCHO Widht	CÓDIGO Code
Roble avellana	279	81J1016
OAM-806 SP	349	81J1017
	430	81J1018
	449	81J1019
	630	81J1020
	699	81J1021
	730	81J1022
	830	81J1023
	899	81J1024
	930	81J1025
	1299	81J1026
	LARGO / Lenght	

REFERENCIA Reference	ANCHO Widht	CÓDIGO Code
Roble aneto	279	81J1027
OAN-807 SP	349	81J1028
	430	81J1029
	449	81J1030
	630	81J1031
	699	81J1032
	730	81J1033
	830	81J1034
	899	81J1035
	930	81J1036
	1299	81J1037
	LARGO / Lenght	

REFERENCIA Reference	ANCHO Widht	CÓDIGO Code
Roble tostado	279	81J1038
OAT-808 SP	349	81J1039
	430	81J1040
	449	81J1041
	630	81J1042
	699	81J1043
	730	81J1044
	830	81J1045
	899	81J1046
	930	81J1047
	1299	81J1048
	LARGO / Lenght	

BANDA INTEGRADA "U"*"U" Integrated bar***■ CARACTERÍSTICAS TÉCNICAS:**

Terminación: perfil tirador postformado tipo "U".
 Soporte: tablero aglomerado.
 Recubrimiento: capa melamínica interna prensada, más laminado sintético PET/TSL externo acabado en súper mate (SP) y film protector.
 Contracara: simil.
 Adhesivo: cola PUR (poliuretano reactivo prensado en frío).
 Espesor: 19 mm.

■ FEATURES:

Finish: profile handle postforming type "U".
 Core: particle board.
 Covering: internal melaminica cape press plus synthetic decorative laminate PET/TSL finish super-matte (SP) and protective film.
 Backside: similar
 Adhesive: PUR glue (old press reactive polyurethane).
 Thickness: 19 mm.

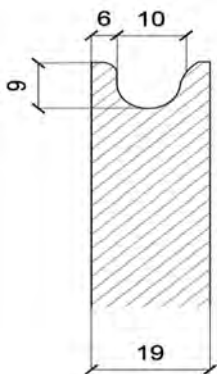
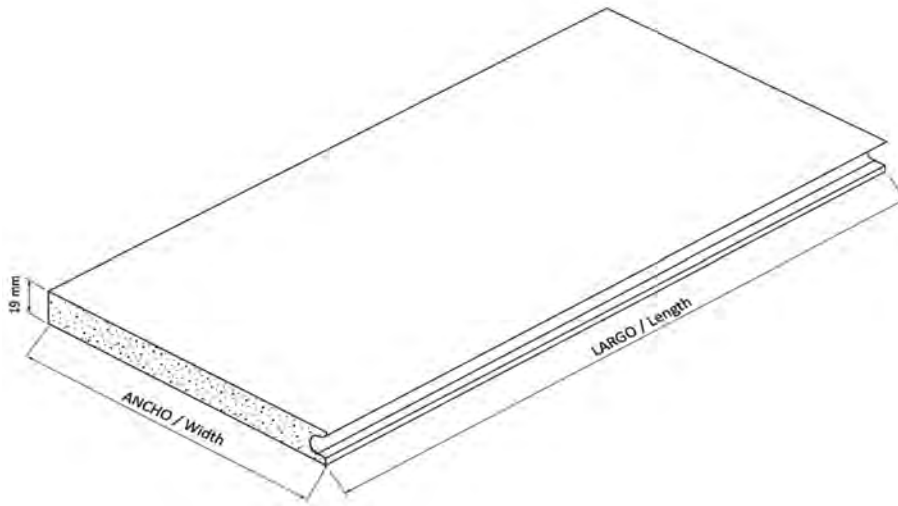
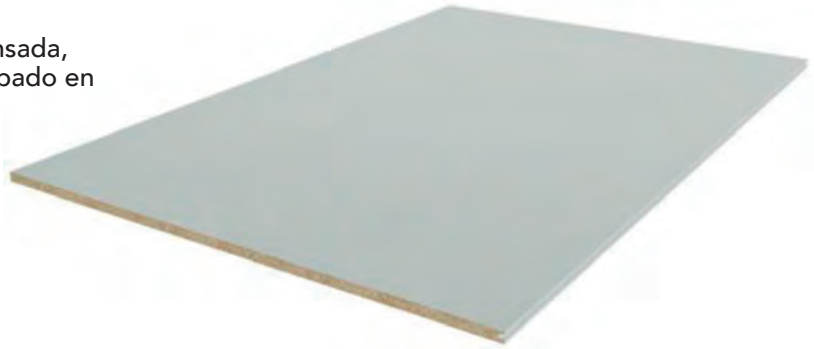
**■ CARACTERÍSTICAS TÉCNICAS:**

- Paquete estándar 15 unidades por medida y diseño.
- Por unidad, consultar condiciones.

■ FEATURES:

- Standard package 15 units per measurement and design.
- Per unit, ask about conditions.

MEDIDAS Y PESOS Dimensions and weights	
LARGO X ANCHO Length x width	PESO BANDA Bar weight
2850x279x19 mm.	10,31 kg.
2850x349x19 mm.	12,89 kg.
2850x430x19 mm.	15,83 kg.
2850x449x19 mm.	16,57 kg.
2850x630x19 mm.	22,95 kg.
2850x699x19 mm.	25,77 kg.
2850x730x19 mm.	26,88 kg.
2850x830x19 mm.	30,56 kg.
2850x899x19 mm.	33,14 kg.
2850x930x19 mm.	32,24 kg.
2850x1185x19 mm.	43,18 kg.
2800x1299x19 mm.	47,03 kg.

Dimensiones según diseño.*Dimensions according to design.*

DISEÑOS BANDA INTEGRADA "U" 19 mm

19 mm designs "U" integrated bar

REFERENCIA Reference	ANCHO Widht	CÓDIGO Code
Aguamarina urban PEM-051 SP 	279	82U0694
	349	82U0695
	430	82U0696
	449	82U0697
	630	82U0698
	699	82U0699
	730	82U0700
	830	82U0701
	899	82U0702
	930	82U0703
	1185	82U0704
LARGO / Lenght		2850

REFERENCIA Reference	ANCHO Widht	CÓDIGO Code
Burdeos teja PEM-052 SP 	279	82U0705
	349	82U0706
	430	82U0707
	449	82U0708
	630	82U0709
	699	82U0710
	730	82U0711
	830	82U0712
	899	82U0713
	930	82U0714
	1185	82U0715
LARGO / Lenght		2850

REFERENCIA Reference	ANCHO Widht	CÓDIGO Code
Cacao PEM-055 SP 	279	82U0716
	349	82U0717
	430	82U0718
	449	82U0719
	630	82U0720
	699	82U0721
	730	82U0722
	830	82U0723
	899	82U0724
	930	82U0725
	1299	82U0859
LARGO / Lenght		2850

REFERENCIA Reference	ANCHO Widht	CÓDIGO Code
Ceniza PEM-056 SP 	279	82U0727
	349	82U0728
	430	82U0729
	449	82U0730
	630	82U0731
	699	82U0732
	730	82U0733
	830	82U0734
	899	82U0735
	930	82U0736
	1299	82U0860
LARGO / Lenght		2850

REFERENCIA Reference	ANCHO Widht	CÓDIGO Code
Gris oscuro PEM-057 SP 	279	82U0738
	349	82U0739
	430	82U0740
	449	82U0741
	630	82U0742
	699	82U0743
	730	82U0744
	830	82U0745
	899	82U0746
	930	82U0747
	1299	82U0861
LARGO / Lenght		2850

REFERENCIA Reference	ANCHO Widht	CÓDIGO Code
Café Latte PEM-058 SP 	279	82U0749
	349	82U0750
	430	82U0751
	449	82U0752
	630	82U0753
	699	82U0754
	730	82U0755
	830	82U0756
	899	82U0757
	930	82U0758
	1299	82U0862
LARGO / Lenght		2850

REFERENCIA Reference	ANCHO Widht	CÓDIGO Code
Blanco Finlandia PEM-060 SP 	279	82U0760
	349	82U0761
	430	82U0762
	449	82U0763
	630	82U0764
	699	82U0765
	730	82U0766
	830	82U0767
	899	82U0768
	930	82U0769
	1299	82U0863
LARGO / Lenght		2850

REFERENCIA Reference	ANCHO Widht	CÓDIGO Code
Capuchino PEM-061 SP 	279	82U0771
	349	82U0772
	430	82U0773
	449	82U0774
	630	82U0775
	699	82U0776
	730	82U0777
	830	82U0778
	899	82U0779
	930	82U0780
	1299	82U0864
LARGO / Lenght		2850

REFERENCIA Reference	ANCHO Widht	CÓDIGO Code
Rojo cherry PEM-063 SP 	279	82U0782
	349	82U0783
	430	82U0784
	449	82U0785
	630	82U0786
	699	82U0787
	730	82U0788
	830	82U0789
	899	82U0790
	930	82U0791
	1299	82U0865
LARGO / Lenght		2850

REFERENCIA Reference	ANCHO Widht	CÓDIGO Code
Negro Madagascar PEM-064 SP 	279	82U0793
	349	82U0794
	430	82U0795
	449	82U0796
	630	82U0797
	699	82U0798
	730	82U0799
	830	82U0800
	899	82U0801
	930	82U0802
	1299	82U0866
LARGO / Lenght		2850

REFERENCIA Reference	ANCHO Widht	CÓDIGO Code
Roble claro OAC-809 SP 	279	82U0837
	349	82U0838
	430	82U0839
	449	82U0840
	630	82U0841
	699	82U0842
	730	82U0843
	830	82U0844
	899	82U0845
	930	82U0846
	1299	82U0847
LARGO / Lenght		2800

REFERENCIA Reference	ANCHO Widht	CÓDIGO Code
Roble elegance OAD-822 SP 	279	82U0848
	349	82U0849
	430	82U0850
	449	82U0851
	630	82U0852
	699	82U0853
	730	82U0854
	830	82U0855
	899	82U0856
	930	82U0857
	1299	82U0858
LARGO / Lenght		2800

DISEÑOS BANDA INTEGRADA "U" 19 mm

19 mm designs "U" integrated bar

REFERENCIA Reference	ANCHO Widht	CÓDIGO Code
Roble avellana	279	82U0804
OAM-806 SP	349	82U0805
	430	82U0806
	449	82U0807
	630	82U0808
	699	82U0809
	730	82U0810
	830	82U0811
	899	82U0812
	930	82U0813
	1299	82U0814
	LARGO / Lenght	

REFERENCIA Reference	ANCHO Widht	CÓDIGO Code
Roble aneto	279	82U0815
OAN-807 SP	349	82U0816
	430	82U0817
	449	82U0818
	630	82U0819
	699	82U0820
	730	82U0821
	830	82U0822
	899	82U0823
	930	82U0824
	1299	82U0825
	LARGO / Lenght	

REFERENCIA Reference	ANCHO Widht	CÓDIGO Code
Roble tostado	279	82U0826
OAT-808 SP	349	82U0827
	430	82U0828
	449	82U0829
	630	82U0830
	699	82U0831
	730	82U0832
	830	82U0833
	899	82U0834
	930	82U0835
	1299	82U0836
	LARGO / Lenght	

BANDA POSTFORMADA

Postformed bar

■ CARACTERÍSTICAS TÉCNICAS:

Terminación: postformado con radio 1 mm.
 Soporte: tablero aglomerado.
 Recubrimiento: capa melaminica interna prensada, más laminado sintético PET/TSL externo acabado en súper mate (SP) y film protector.
 Contracara: simil.
 Adhesivo: cola PUR (poliuretano reactivo prensado en frio).
 Espesor: 19 mm.



■ FEATURES:

Finish: 1 mm radius postformed.
 Core: particle board.
 Covering: internal melaminica cape press plus synthetic decorative laminate PET/TSL finish super-matte (SP) and protective film.
 Backside: similar
 Adhesive: PUR glue (old press reactive polyurethane).
 Thickness: 19 mm.

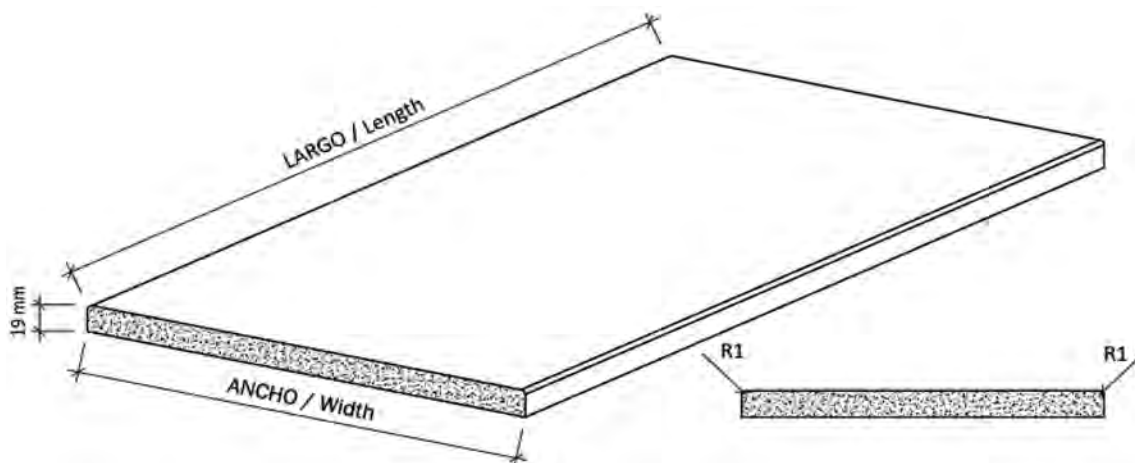

■ CARACTERÍSTICAS TÉCNICAS:

- Paquete estándar 15 unidades por medida y diseño.
- Por unidad, consultar condiciones.

■ FEATURES:

- Standard package 15 units per measurement and design.
- Per unit, ask about conditions.

MEDIDAS Y PESOS Dimensions and weights	
LARGO X ANCHO Length x width	PESO BANDA Bar weight
2850x147x19 mm	5,85 kg
2850x247x19 mm	9,70 kg.
2850x297x19 mm	11,65 kg.
2850x347x19 mm	13,60 kg.
2850x397x19 mm	15,50 kg.
2850x447x19 mm	17,45 kg.
2850x497x19 mm	19,40 kg.
2850x597x19 mm	23,25 kg.
2850x697x19 mm	27,20 kg.
2850x897x19 mm	34,90 kg.

Dimensiones según diseño.
 Dimensions according to design.

DISEÑOS BANDA POSTFORMADA 19 mm

19 mm designs postformed bar

REFERENCIA Reference	ANCHO Widht	CÓDIGO Code	
Blanco Finlandia	147	2800346	
	247	2800348	
PEM-060 SP 	297	2800349	
	347	2800350	
	397	2800351	
	447	2800352	
	497	2800353	
	597	2800354	
	697	2800355	
	897	2800356	
	LARGO / Lenght		
	2850		

D.

premium pet



TABLERO

Board

■ CARACTERÍSTICAS TÉCNICAS:

Terminación: en recto.
 Soporte: tablero MDF.
 Recubrimiento: capa melaminica interna prensada, más laminado decorativo sintético PET externo acabado súper brillo, súper mate (SP) y texturados con film protector.
 Contracara: símil.
 Adhesivo: cola PUR (poliuretano reactivo prensado en frio).
 Espesor: 22 mm.

■ FEATURES:

Finish in straight.
 Core: MDF board.
 Covering: internal melaminica cape press plus synthetic decorative laminate PET finish super-shiny, super-matte (SP) and textured with protective film.
 Backside: similar
 Adhesive: PUR glue (old press reactive polyurethane).
 Thickness: 22 mm.

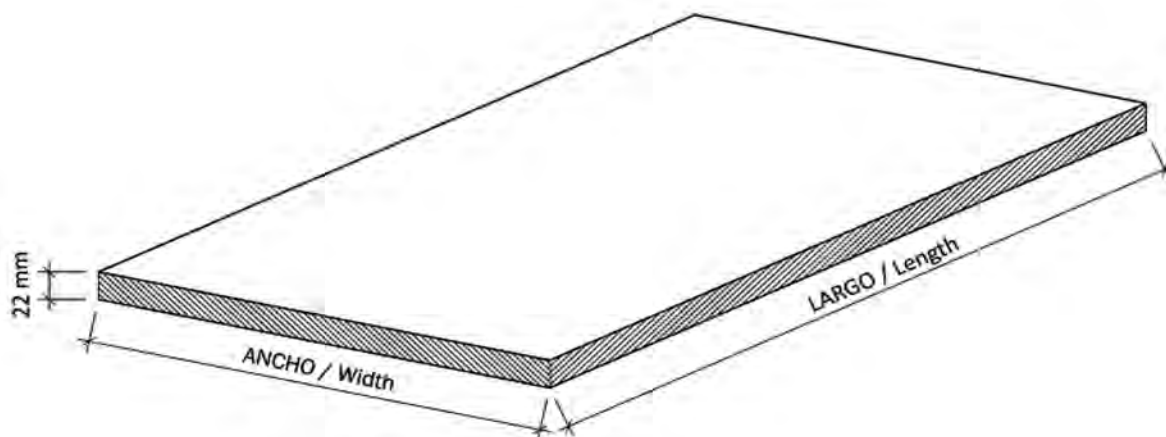
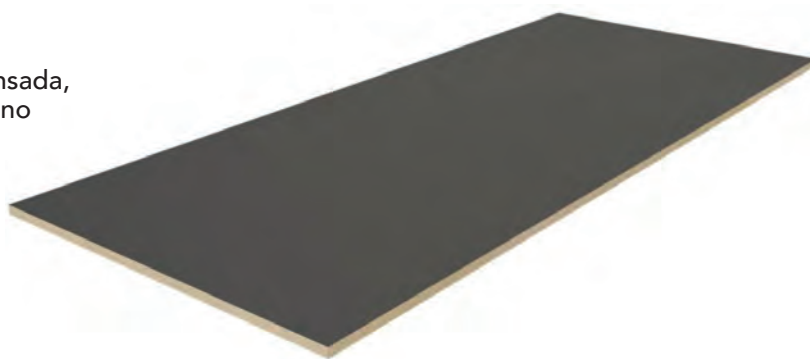
**■ CARACTERÍSTICAS TÉCNICAS:**

- Paquete estándar 15 unidades por medida y diseño.
- Por unidad, consultar condiciones.

■ FEATURES:

- Standard package 15 units per measurement and design.
- Per unit, ask about conditions.

MEDIDAS Y PESOS Dimensions and weights	
LARGO X ANCHO Length x width	PESO TABLERO Board weight
2850x1220x22 mm.	52,00 kg.

Dimensiones según diseño.
 Dimensions according to design.

DISEÑOS TABLERO 22 mm

22 mm Designs board

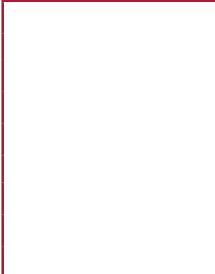
	REFERENCIA Reference
	Blanco Finlandia PEB-070 BRILLO
	MEDIDA Measure
	2850x1220x22
CÓDIGO / Code	
4700878	

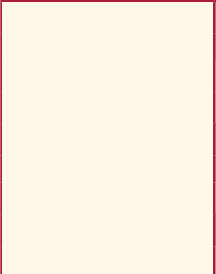
	REFERENCIA Reference
	Crema PEB-071 BRILLO
	MEDIDA Measure
	2850x1220x22
CÓDIGO / Code	
4700879	

	REFERENCIA Reference
	Lava PEB-072 BRILLO
	MEDIDA Measure
	2850x1220x22
CÓDIGO / Code	
4700880	

	REFERENCIA Reference
	Gris oscuro PEB-073 BRILLO
	MEDIDA Measure
	2850x1220x22
CÓDIGO / Code	
4700882	

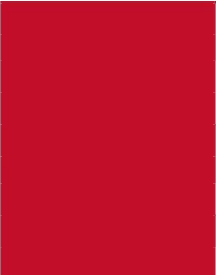
	REFERENCIA Reference
	Rojo cherry PEB-077 BRILLO
	MEDIDA Measure
	2850x1220x22
CÓDIGO / Code	
4700883	

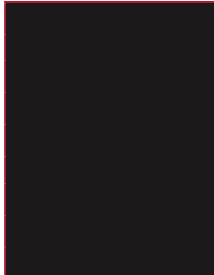
	REFERENCIA Reference
	Negro Madagascar PEB-078 BRILLO
	MEDIDA Measure
	2850x1220x22
CÓDIGO / Code	
4700888	

	REFERENCIA Reference
	Café Latte PEB-080 BRILLO
	MEDIDA Measure
	2850x1220x22
CÓDIGO / Code	
4700885	

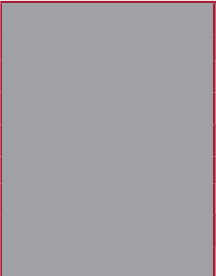
	REFERENCIA Reference
	Ceniza PEB-081 BRILLO
	MEDIDA Measure
	2850x1220x22
CÓDIGO / Code	
4700886	

	REFERENCIA Reference
	Burdeos teja PEB-085 BRILLO
	MEDIDA Measure
	2850x1220x22
CÓDIGO / Code	
4701570	

	REFERENCIA Reference
	Aguamarina urban PEB-086 BRILLO
	MEDIDA Measure
	2850x1220x22
CÓDIGO / Code	
4701571	

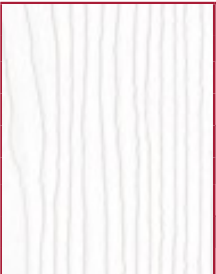
	REFERENCIA Reference
	Blanco Suecia PER-001 GRAIN
	MEDIDA Measure
	2850x1220x22
CÓDIGO / Code	
4701574	

	REFERENCIA Reference
	Arena Sahara PER-002 GRAIN
	MEDIDA Measure
	2850x1220x22
CÓDIGO / Code	
4701575	

	REFERENCIA Reference
	Gris Londres PER-003 GRAIN
	MEDIDA Measure
	2850x1220x22
CÓDIGO / Code	
4701576	

	REFERENCIA Reference
	Bronce PEW-100 METALLIC
	MEDIDA Measure
	2850x1220x22
CÓDIGO / Code	
4701577	

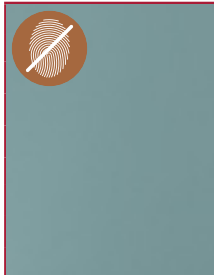
	REFERENCIA Reference
	Aguamarina urban PEM-051 SP
	MEDIDA Measure
	2850x1220x22
CÓDIGO / Code	
4701572	

	REFERENCIA Reference
	Burdeos teja PEM-052 SP
	MEDIDA Measure
	2850x1220x22
CÓDIGO / Code	
4701573	

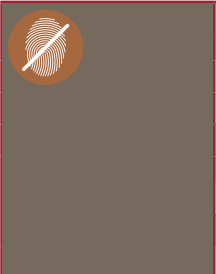
	REFERENCIA Reference
	Cacao PEM-055 SP
	MEDIDA Measure
	2850x1220x22
CÓDIGO / Code	
4700887	

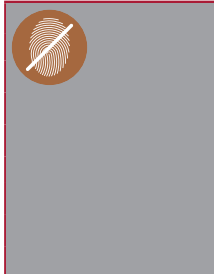
	REFERENCIA Reference
	Ceniza PEM-056 SP
	MEDIDA Measure
	2850x1220x22
CÓDIGO / Code	
4700889	

DISEÑOS TABLERO 22 mm

22 mm Designs board

	REFERENCIA <i>Reference</i>
	Gris oscuro PEM-057 SP
	MEDIDA <i>Measure</i>
	2850x1220x22
	CÓDIGO / <i>Code</i>
	4700890

	REFERENCIA <i>Reference</i>
	Café Latte PEM-058 SP
	MEDIDA <i>Measure</i>
	2850x1220x22
	CÓDIGO / <i>Code</i>
	4700891

	REFERENCIA <i>Reference</i>
	Blanco Finlandia PEM-060 SP
	MEDIDA <i>Measure</i>
	2850x1220x22
	CÓDIGO / <i>Code</i>
	4700892

	REFERENCIA <i>Reference</i>
	Capuchino PEM-061 SP
	MEDIDA <i>Measure</i>
	2850x1220x22
	CÓDIGO / <i>Code</i>
	4700893

	REFERENCIA <i>Reference</i>
	Rojo cherry PEM-063 SP
	MEDIDA <i>Measure</i>
	2850x1220x22
	CÓDIGO / <i>Code</i>
	4700895

	REFERENCIA <i>Reference</i>
	Negro Madagascar PEM-064 SP
	MEDIDA <i>Measure</i>
	2850x1220x22
	CÓDIGO / <i>Code</i>
	4701089

BANDA INTEGRADA "J"

"J" Integrated bar

■ CARACTERÍSTICAS TÉCNICAS:

Terminación: perfil tirador postformado tipo "J".

Soporte: tablero MDF.

Recubrimiento: capa melaminica interna prensada, más laminado decorativo sintético PET externo acabado en súper brillo, súper mate (SP) y texturados con film protector.

Contracara: simil.

Adhesivo: cola PUR (poliuretano reactivo prensado en frio).

Espesor: 22 mm.

■ FEATURES:

Finish: profile handle postforming type "J"

Core: MDF board.

Covering: internal melaminica cape press plus synthetic decorative laminate PET finish super-shiny, super-matte (SP) and textured with protective film.

Backside: similar

Adhesive: PUR glue (old press reactive polyurethane).

Thickness: 22 mm.

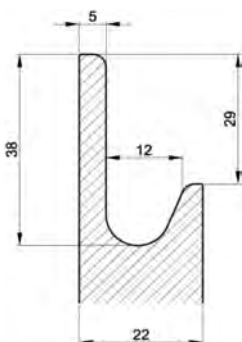
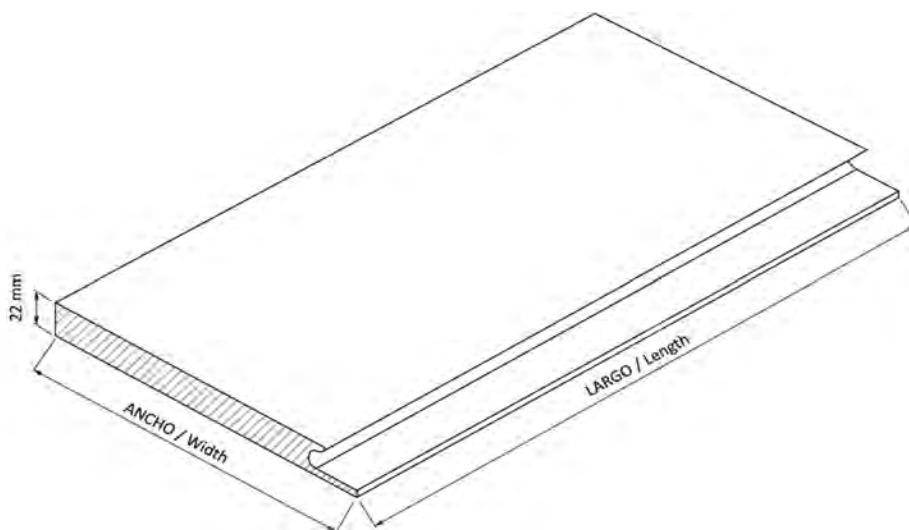
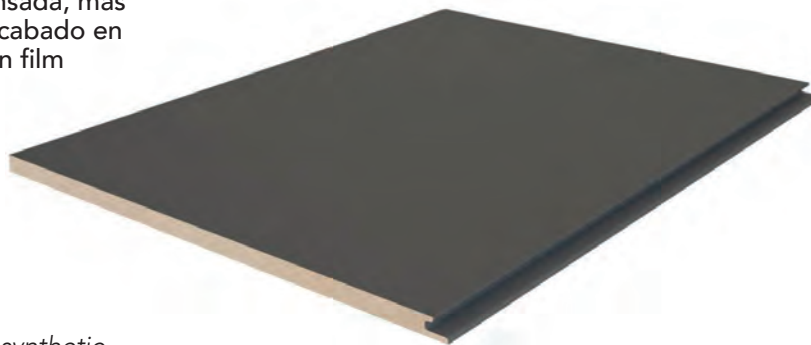

■ CARACTERÍSTICAS TÉCNICAS:

- Paquete estándar 15 unidades por medida y diseño.
- Por unidad, consultar condiciones.

■ FEATURES:

- Standard package 15 units per measurement and design.
- Per unit, ask about conditions.

MEDIDAS Y PESOS Dimensions and weights	
LARGO X ANCHO Length x width	PESO BANDA Bar weight
2850x0260x22 mm.	11,10 kg.
2850x0279x22 mm.	11,95 kg.
2850x0349x22 mm.	14,95 kg.
2850x0430x22 mm.	18,35 kg.
2850x0449x22 mm.	19,20 kg.
2850x0630x22 mm.	26,90 kg.
2850x0699x22 mm.	29,85 kg.
2850x0730x22 mm.	31,15 kg.
2850x0799x22 mm.	34,10 kg.
2850x0830x22 mm.	35,40 kg.
2850x0899x22 mm.	38,40 kg.
2850x0930x22 mm.	39,65 kg.
2850x1185x22 mm.	50,55 kg.
2850x1299x22 mm.	54,45 kg.

Dimensiones según diseño.

Dimensions according to design.

DISEÑOS BANDA INTEGRADA "J" 22 mm

22 mm designs "J" integrated bar

REFERENCIA Reference	ANCHO Widht	CÓDIGO Code
Blanco Finlandia	260	21P0085
PEB-070 BRILLO	279	21P0002
	349	21P0003
	430	21P0086
	449	21P0004
	630	21P0087
	699	21P0005
	730	21P0088
	799	21P0225
	830	21P0089
	899	21P0006
	930	21P0090
	LARGO/Lenght 2850	1299

REFERENCIA Reference	ANCHO Widht	CÓDIGO Code
Crema	260	21P0092
PEB-071 BRILLO	279	21P0008
	349	21P0009
	430	21P0093
	449	21P0010
	630	21P0094
	699	21P0011
	730	21P0095
	799	21P0407
	830	21P0096
	899	21P0012
	930	21P0097
	LARGO/Lenght 2850	1299

REFERENCIA Reference	ANCHO Widht	CÓDIGO Code
Lava	260	21P0099
PEB-072 BRILLO	279	21P0014
	349	21P0015
	430	21P0100
	449	21P0016
	630	21P0101
	699	21P0017
	730	21P0102
	799	21P0408
	830	21P0103
	899	21P0018
	930	21P0104
	LARGO/Lenght 2850	1299

REFERENCIA Reference	ANCHO Widht	CÓDIGO Code
Gris oscuro	260	21P0106
PEB-073 BRILLO	279	21P0020
	349	21P0021
	430	21P0107
	449	21P0022
	630	21P0108
	699	21P0023
	730	21P0109
	799	21P0409
	830	21P0110
	899	21P0024
	930	21P0111
	LARGO/Lenght 2850	1299

REFERENCIA Reference	ANCHO Widht	CÓDIGO Code
Rojo cherry	260	21P0113
PEB-077 BRILLO	279	21P0026
	349	21P0027
	430	21P0114
	449	21P0028
	630	21P0115
	699	21P0029
	730	21P0116
	799	21P0410
	830	21P0117
	899	21P0030
	930	21P0118
	LARGO/Lenght 2850	1299

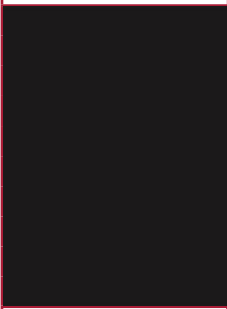
REFERENCIA Reference	ANCHO Widht	CÓDIGO Code
Negro Madagascar	260	21P0184
PEB-078 BRILLO	279	21P0185
	349	21P0186
	430	21P0187
	449	21P0188
	630	21P0189
	699	21P0190
	730	21P0191
	799	21P0411
	830	21P0192
	899	21P0193
	930	21P0194
	LARGO/Lenght 2850	1299

REFERENCIA Reference	ANCHO Widht	CÓDIGO Code
Café Latte	260	21P0120
PEB-080 BRILLO	279	21P0032
	349	21P0033
	430	21P0121
	449	21P0034
	630	21P0122
	699	21P0035
	730	21P0123
	799	21P0412
	830	21P0124
	899	21P0036
	930	21P0125
	LARGO/Lenght 2850	1299

REFERENCIA Reference	ANCHO Widht	CÓDIGO Code
Ceniza	260	21P0127
PEB-081 BRILLO	279	21P0038
	349	21P0039
	430	21P0128
	449	21P0040
	630	21P0129
	699	21P0041
	730	21P0130
	799	21P0413
	830	21P0131
	899	21P0042
	930	21P0132
	LARGO/Lenght 2850	1299

REFERENCIA Reference	ANCHO Widht	CÓDIGO Code
Burdeos teja	260	21P0228
PEB-085 BRILLO	279	21P0229
	349	21P0230
	430	21P0231
	449	21P0232
	630	21P0233
	699	21P0234
	730	21P0235
	799	21P0236
	830	21P0237
	899	21P0238
	930	21P0239
	LARGO/Lenght 2850	1185

REFERENCIA Reference	ANCHO Widht	CÓDIGO Code
Aguamarina urban	260	21P0243
PEB-086 BRILLO	279	21P0244
	349	21P0245
	430	21P0246
	449	21P0247
	630	21P0248
	699	21P0249
	730	21P0250
	799	21P0251
	830	21P0252
	899	21P0253
	930	21P0254
	LARGO/Lenght 2850	1299

REFERENCIA Reference	ANCHO Widht	CÓDIGO Code
Blanco Suecia	260	21P0288
PER-001 GRAIN	279	21P0289
	349	21P0290
	430	21P0291
	449	21P0292
	630	21P0293
	699	21P0294
	730	21P0295
	799	21P0296
	830	21P0297
	899	21P0298
	930	21P0299
	LARGO/Lenght 2850	1299

REFERENCIA Reference	ANCHO Widht	CÓDIGO Code
Arena Sahara	260	21P0303
PER-002 GRAIN	279	21P0304
	349	21P0305
	430	21P0306
	449	21P0307
	630	21P0308
	699	21P0309
	730	21P0310
	799	21P0311
	830	21P0312
	899	21P0313
	930	21P0314
	LARGO/Lenght 2850	1299

DISEÑOS BANDA INTEGRADA "J" 22 mm

22 mm designs "J" integrated bar

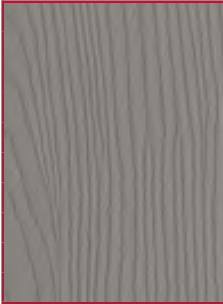
REFERENCIA Reference	ANCHO Widht	CÓDIGO Code
Gris Londres	260	21P0318
PER-003 GRAIN	279	21P0319
	349	21P0320
	430	21P0321
	449	21P0322
	630	21P0323
	699	21P0324
	730	21P0325
	799	21P0326
	830	21P0327
	899	21P0328
	930	21P0329
	LARGO/Lenght 2850	1299

REFERENCIA Reference	ANCHO Widht	CÓDIGO Code
Bronce	260	21P0333
PEW-100 METALLIC	279	21P0334
	349	21P0335
	430	21P0336
	449	21P0337
	630	21P0338
	699	21P0339
	730	21P0340
	799	21P0341
	830	21P0342
	899	21P0343
	930	21P0344
	LARGO/Lenght 2850	1185

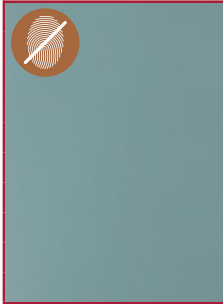
REFERENCIA Reference	ANCHO Widht	CÓDIGO Code
Aguamarina urban	260	21P0258
PEM-051 SP	279	21P0259
	349	21P0260
	430	21P0261
	449	21P0262
	630	21P0263
	699	21P0264
	730	21P0265
	799	21P0266
	830	21P0267
	899	21P0268
	930	21P0269
	LARGO/Lenght 2850	1185

REFERENCIA Reference	ANCHO Widht	CÓDIGO Code
Burdeos teja	260	21P0273
PEM-052 SP	279	21P0274
	349	21P0275
	430	21P0276
	449	21P0277
	630	21P0278
	699	21P0279
	730	21P0280
	799	21P0281
	830	21P0282
	899	21P0283
	930	21P0284
	LARGO/Lenght 2850	1185

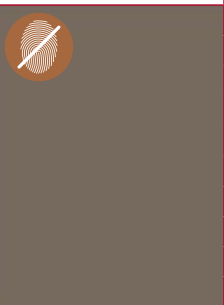
REFERENCIA Reference	ANCHO Widht	CÓDIGO Code
Cacao	260	21P0134
PEM-055 SP	279	21P0044
	349	21P0045
	430	21P0135
	449	21P0046
	630	21P0136
	699	21P0047
	730	21P0137
	799	21P0414
	830	21P0138
	899	21P0048
	930	21P0139
	LARGO/Lenght 2850	1299

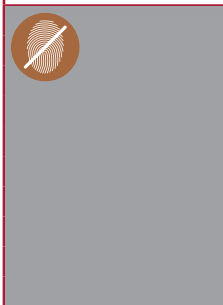
REFERENCIA Reference	ANCHO Widht	CÓDIGO Code
Ceniza	260	21P0141
PEM-056 SP	279	21P0050
	349	21P0051
	430	21P0142
	449	21P0052
	630	21P0143
	699	21P0053
	730	21P0144
	799	21P0415
	830	21P0145
	899	21P0054
	930	21P0146
	LARGO/Lenght 2850	1299

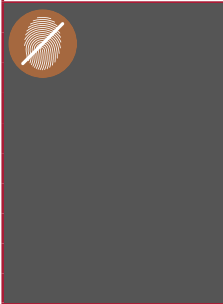
REFERENCIA Reference	ANCHO Widht	CÓDIGO Code
Gris oscuro	260	21P0148
PEM-057 SP	279	21P0056
	349	21P0057
	430	21P0149
	449	21P0058
	630	21P0150
	699	21P0059
	730	21P0151
	799	21P0416
	830	21P0152
	899	21P0060
	930	21P0153
	LARGO/Lenght 2850	1299

REFERENCIA Reference	ANCHO Widht	CÓDIGO Code
Café Latte	260	21P0155
PEM-058 SP	279	21P0062
	349	21P0063
	430	21P0156
	449	21P0064
	630	21P0157
	699	21P0065
	730	21P0158
	799	21P0417
	830	21P0159
	899	21P0066
	930	21P0160
	LARGO/Lenght 2850	1299

REFERENCIA Reference	ANCHO Widht	CÓDIGO Code
Blanco Finlandia	260	21P0162
PEM-060 SP	279	21P0068
	349	21P0069
	430	21P0163
	449	21P0070
	630	21P0164
	699	21P0071
	730	21P0165
	799	21P0226
	830	21P0166
	899	21P0072
	930	21P0167
	LARGO/Lenght 2850	1299

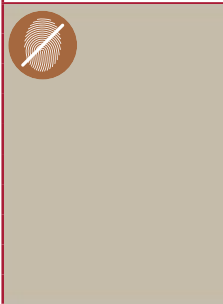
REFERENCIA Reference	ANCHO Widht	CÓDIGO Code
Capuchino	260	21P0169
PEM-061 SP	279	21P0074
	349	21P0075
	430	21P0170
	449	21P0076
	630	21P0171
	699	21P0077
	730	21P0172
	799	21P0418
	830	21P0173
	899	21P0078
	930	21P0174
	LARGO/Lenght 2850	1299

REFERENCIA Reference	ANCHO Widht	CÓDIGO Code
Rojo cherry	260	21P0176
PEM-063 SP	279	21P0080
	349	21P0081
	430	21P0177
	449	21P0082
	630	21P0178
	699	21P0083
	730	21P0179
	799	21P0419
	830	21P0180
	899	21P0084
	930	21P0181
	LARGO/Lenght 2850	1299

REFERENCIA Reference	ANCHO Widht	CÓDIGO Code
Negro Madagascar	260	21P0197
PEM-064 SP	279	21P0198
	349	21P0199
	430	21P0200
	449	21P0201
	630	21P0202
	699	21P0203
	730	21P0204
	799	21P0420
	830	21P0205
	899	21P0206
	930	21P0207
	LARGO/Lenght 2850	1299

BANDA INTEGRADA "U"*"U" Integrated bar***■ CARACTERÍSTICAS TÉCNICAS:**

Terminación: perfil tirador postformado tipo "U".

Soporte: tablero MDF.

Recubrimiento: capa melaminica interna prensada, más laminado decorativo sintético PET externo acabado en súper brillo, súper mate (SP) y texturados con film protector.

Contracara: simil.

Adhesivo: cola PUR (poliuretano reactivo prensado en frio).

Espesor: 22 mm.

■ FEATURES:

Finish: profile handle postforming type "U"

Core: MDF board.

Covering: internal melaminica cape press plus synthetic decorative laminate PET finish super-shiny, super-matte (SP) and textured with protective film.

Backside: similar

Adhesive: PUR glue (old press reactive polyurethane).

Thickness: 22 mm.

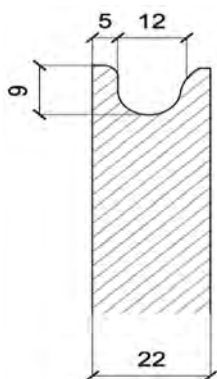
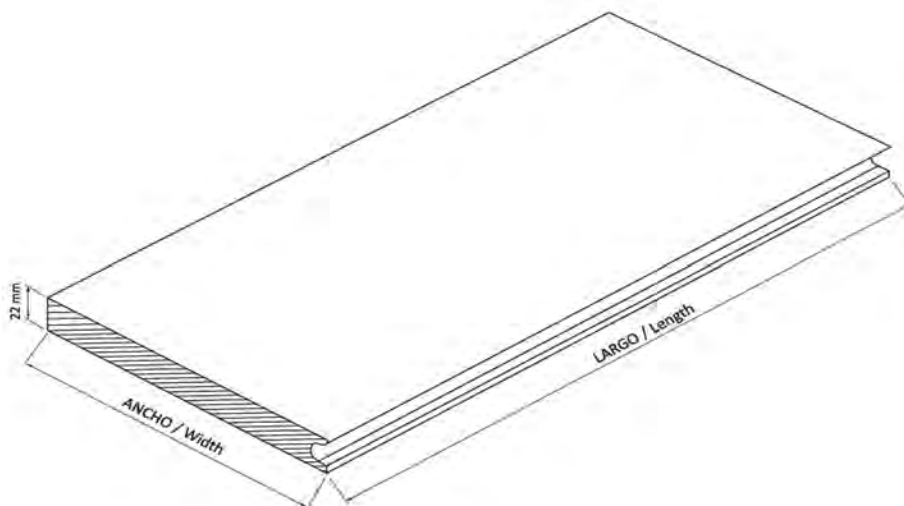
**■ CARACTERÍSTICAS TÉCNICAS:**

- Paquete estándar 15 unidades por medida y diseño.
- Por unidad, consultar condiciones.

■ FEATURES:

- Standard package 15 units per measurement and design.
- Per unit, ask about conditions.

MEDIDAS Y PESOS Dimensions and weights	
LARGO X ANCHO Length x width	PESO BANDA Bar weight
2850x0260x22 mm.	11,10 kg.
2850x0279x22 mm.	11,95 kg.
2850x0349x22 mm.	14,95 kg.
2850x0430x22 mm.	18,35 kg.
2850x0449x22 mm.	19,20 kg.
2850x0630x22 mm.	26,90 kg.
2850x0699x22 mm.	29,85 kg.
2850x0730x22 mm.	31,15 kg.
2850x0799x22 mm.	34,10 kg.
2850x0830x22 mm.	35,40 kg.
2850x0899x22 mm.	38,40 kg.
2850x0930x22 mm.	39,65 kg.
2850x1185x22 mm.	50,55 kg.
2850x1299x22 mm.	54,45 kg.

Dimensiones según diseño.

Dimensions according to design.

DISEÑOS BANDA INTEGRADA "U" 22 mm

22 mm designs "U" integrated bar

REFERENCIA Reference	ANCHO Widht	CÓDIGO Code
Blanco Finlandia	279	22U0181
PEB-070 BRILLO	349	22U0182
	430	22U0183
	449	22U0184
	630	22U0185
	699	22U0186
	730	22U0187
	799	22U0188
	830	22U0189
	899	22U0190
	930	22U0191
LARGO/Lenght 2850	1299	22U0192

REFERENCIA Reference	ANCHO Widht	CÓDIGO Code
Crema	279	22U0097
PEB-071 BRILLO	349	22U0098
	430	22U0099
	449	22U0100
	630	22U0101
	699	22U0102
	730	22U0103
	799	22U0104
	830	22U0105
	899	22U0106
	930	22U0107
LARGO/Lenght 2850	1299	22U0108

REFERENCIA Reference	ANCHO Widht	CÓDIGO Code
Lava	279	22U0109
PEB-072 BRILLO	349	22U0110
	430	22U0111
	449	22U0112
	630	22U0113
	699	22U0114
	730	22U0115
	799	22U0116
	830	22U0117
	899	22U0118
	930	22U0119
LARGO/Lenght 2850	1299	22U0120

REFERENCIA Reference	ANCHO Widht	CÓDIGO Code
Gris oscuro	279	22U0121
PEB-073 BRILLO	349	22U0122
	430	22U0123
	449	22U0124
	630	22U0125
	699	22U0126
	730	22U0127
	799	22U0128
	830	22U0129
	899	22U0130
	930	22U0131
LARGO/Lenght 2850	1299	22U0132

REFERENCIA Reference	ANCHO Widht	CÓDIGO Code
Rojo cherry	279	22U0133
PEB-077 BRILLO	349	22U0134
	430	22U0135
	449	22U0136
	630	22U0137
	699	22U0138
	730	22U0139
	799	22U0140
	830	22U0141
	899	22U0142
	930	22U0143
LARGO/Lenght 2850	1299	22U0144

REFERENCIA Reference	ANCHO Widht	CÓDIGO Code
Negro Madagascar	279	22U0145
PEB-078 BRILLO	349	22U0146
	430	22U0147
	449	22U0148
	630	22U0149
	699	22U0150
	730	22U0151
	799	22U0152
	830	22U0153
	899	22U0154
	930	22U0155
LARGO/Lenght 2850	1299	22U0156

REFERENCIA Reference	ANCHO Widht	CÓDIGO Code
Café Latte	279	22U0157
PEB-080 BRILLO	349	22U0158
	430	22U0159
	449	22U0160
	630	22U0161
	699	22U0162
	730	22U0163
	799	22U0164
	830	22U0165
	899	22U0166
	930	22U0167
LARGO/Lenght 2850	1299	22U0168

REFERENCIA Reference	ANCHO Widht	CÓDIGO Code
Ceniza	279	22U0169
PEB-081 BRILLO	349	22U0170
	430	22U0171
	449	22U0172
	630	22U0173
	699	22U0174
	730	22U0175
	799	22U0176
	830	22U0177
	899	22U0178
	930	22U0179
LARGO/Lenght 2850	1299	22U0180

REFERENCIA Reference	ANCHO Widht	CÓDIGO Code
Burdeos teja	279	22U0001
PEB-085 BRILLO	349	22U0002
	430	22U0003
	449	22U0004
	630	22U0005
	699	22U0006
	730	22U0007
	799	22U0008
	830	22U0009
	899	22U0010
	930	22U0011
LARGO/Lenght 2850	1185	22U0289

REFERENCIA Reference	ANCHO Widht	CÓDIGO Code
Aguamarina urban	279	22U0013
PEB-086 BRILLO	349	22U0014
	430	22U0015
	449	22U0016
	630	22U0017
	699	22U0018
	730	22U0019
	799	22U0020
	830	22U0021
	899	22U0022
	930	22U0023
LARGO/Lenght 2850	1299	22U0024

REFERENCIA Reference	ANCHO Widht	CÓDIGO Code
Blanco Suecia	279	22U0049
PER-001 GRAIN	349	22U0050
	430	22U0051
	449	22U0052
	630	22U0053
	699	22U0054
	730	22U0055
	799	22U0056
	830	22U0057
	899	22U0058
	930	22U0059
LARGO/Lenght 2850	1299	22U0060

REFERENCIA Reference	ANCHO Widht	CÓDIGO Code
Arena Sahara	279	22U0061
PER-002 GRAIN	349	22U0062
	430	22U0063
	449	22U0064
	630	22U0065
	699	22U0066
	730	22U0067
	799	22U0068
	830	22U0069
	899	22U0070
	930	22U0071
LARGO/Lenght 2850	1299	22U0072

DISEÑOS BANDA INTEGRADA "U" 22 mm

22 mm designs "U" integrated bar

REFERENCIA Reference	ANCHO Widht	CÓDIGO Code
Gris Londres	279	22U0073
PER-003 GRAIN	349	22U0074
	430	22U0075
	449	22U0076
	630	22U0077
	699	22U0078
	730	22U0079
	799	22U0080
	830	22U0081
	899	22U0082
	930	22U0083
	LARGO/Lenght 2850	1299

REFERENCIA Reference	ANCHO Widht	CÓDIGO Code
Bronce	279	22U0085
PEW-100 METALLIC	349	22U0086
	430	22U0087
	449	22U0088
	630	22U0089
	699	22U0090
	730	22U0091
	799	22U0092
	830	22U0093
	899	22U0094
	930	22U0095
	LARGO/Lenght 2850	1185

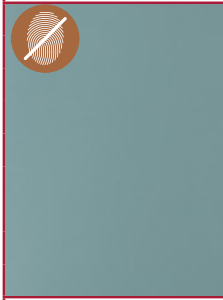
REFERENCIA Reference	ANCHO Widht	CÓDIGO Code
Aguamarina urban	279	22U0025
PEM-051 SP	349	22U0026
	430	22U0027
	449	22U0028
	630	22U0029
	699	22U0030
	730	22U0031
	799	22U0032
	830	22U0033
	899	22U0034
	930	22U0035
	LARGO/Lenght 2850	1185

REFERENCIA Reference	ANCHO Widht	CÓDIGO Code
Burdeos teja	279	22U0037
PEM-052 SP	349	22U0038
	430	22U0039
	449	22U0040
	630	22U0041
	699	22U0042
	730	22U0043
	799	22U0044
	830	22U0045
	899	22U0046
	930	22U0047
	LARGO/Lenght 2850	1185

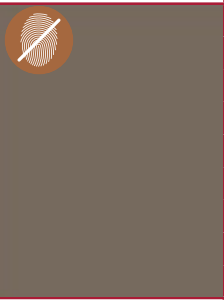
REFERENCIA Reference	ANCHO Widht	CÓDIGO Code
Cacao	279	22U0193
PEM-055 SP	349	22U0194
	430	22U0195
	449	22U0196
	630	22U0197
	699	22U0198
	730	22U0199
	799	22U0200
	830	22U0201
	899	22U0202
	930	22U0203
	LARGO/Lenght 2850	1299

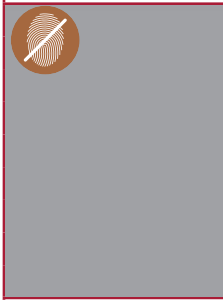
REFERENCIA Reference	ANCHO Widht	CÓDIGO Code
Ceniza	279	22U0205
PEM-056 SP	349	22U0206
	430	22U0207
	449	22U0208
	630	22U0209
	699	22U0210
	730	22U0211
	799	22U0212
	830	22U0213
	899	22U0214
	930	22U0215
	LARGO/Lenght 2850	1299

REFERENCIA Reference	ANCHO Widht	CÓDIGO Code
Gris oscuro	279	22U0217
PEM-057 SP	349	22U0218
	430	22U0219
	449	22U0220
	630	22U0221
	699	22U0222
	730	22U0223
	799	22U0224
	830	22U0225
	899	22U0226
	930	22U0227
	LARGO/Lenght 2850	1299

REFERENCIA Reference	ANCHO Widht	CÓDIGO Code
Café Latte	279	22U0229
PEM-058 SP	349	22U0230
	430	22U0231
	449	22U0232
	630	22U0233
	699	22U0234
	730	22U0235
	799	22U0236
	830	22U0237
	899	22U0238
	930	22U0239
	LARGO/Lenght 2850	1299

REFERENCIA Reference	ANCHO Widht	CÓDIGO Code
Blanco Finlandia	279	22U0277
PEM-060 SP	349	22U0278
	430	22U0279
	449	22U0280
	630	22U0281
	699	22U0282
	730	22U0283
	799	22U0284
	830	22U0285
	899	22U0286
	930	22U0287
	LARGO/Lenght 2850	1299

REFERENCIA Reference	ANCHO Widht	CÓDIGO Code
Capuchino	279	22U0241
PEM-061 SP	349	22U0242
	430	22U0243
	449	22U0244
	630	22U0245
	699	22U0246
	730	22U0247
	799	22U0248
	830	22U0249
	899	22U0250
	930	22U0251
	LARGO/Lenght 2850	1299

REFERENCIA Reference	ANCHO Widht	CÓDIGO Code
Rojo cherry	279	22U0253
PEM-063 SP	349	22U0254
	430	22U0255
	449	22U0256
	630	22U0257
	699	22U0258
	730	22U0259
	799	22U0260
	830	22U0261
	899	22U0262
	930	22U0263
	LARGO/Lenght 2850	1299

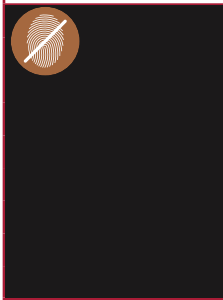
REFERENCIA Reference	ANCHO Widht	CÓDIGO Code
Negro Madagascar	279	22U0265
PEM-064 SP	349	22U0266
	430	22U0267
	449	22U0268
	630	22U0269
	699	22U0270
	730	22U0271
	799	22U0272
	830	22U0273
	899	22U0274
	930	22U0275
	LARGO/Lenght 2850	1299

BANDA INTEGRADA 45°

45° Integrated bar

■ CARACTERÍSTICAS TÉCNICAS:

Terminación: perfil tirador postformado tipo "45°".
 Soporte: tablero MDF.
 Recubrimiento: capa melaminica interna prensada, más laminado decorativo sintético PET externo acabado en súper brillo, súper mate (SP) y texturados con film protector.
 Contracara: simil.
 Adhesivo: cola PUR (poliuretano reactivo prensado en frio).
 Espesor: 22 mm.

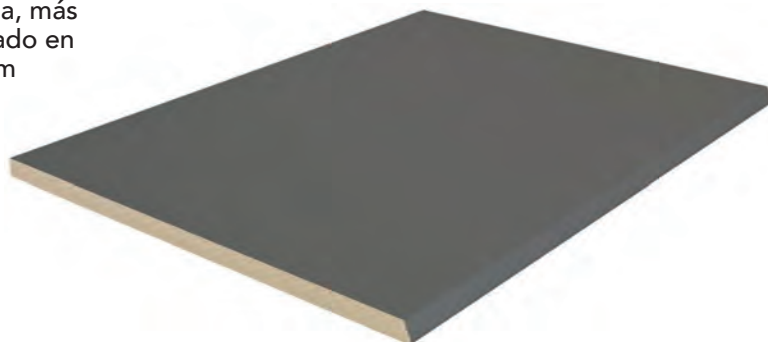

■ FEATURES:

Finish: profile handle postforming type "45°"
 Core: MDF board.
 Covering: internal melaminica cape press plus synthetic decorative laminate PET finish super-shiny, super-matte (SP) and textured with protective film.
 Backside: similar
 Adhesive: PUR glue (old press reactive polyurethane).
 Thickness: 22 mm.

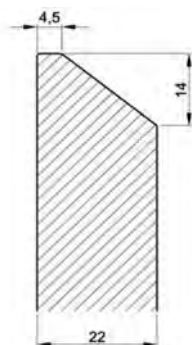
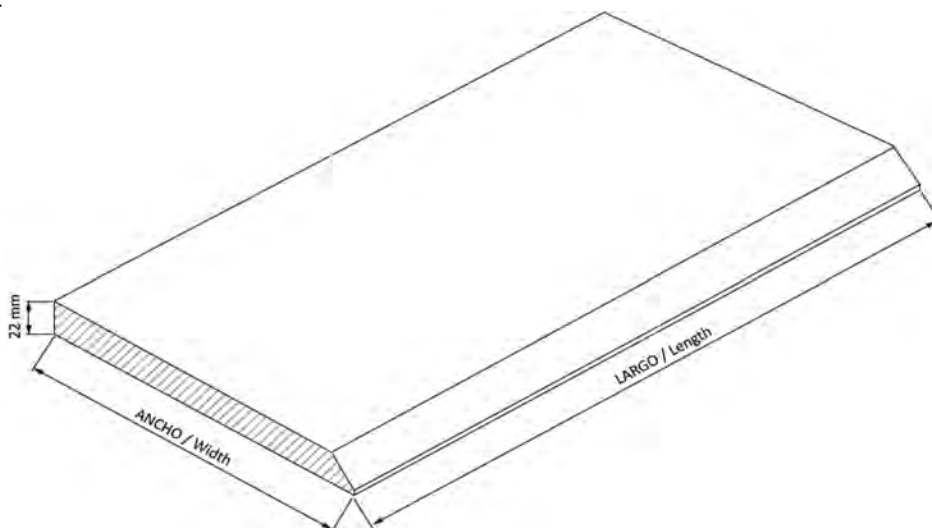

■ CARACTERÍSTICAS TÉCNICAS:

- Paquete estándar 15 unidades por medida y diseño.
- Por unidad, consultar condiciones.

■ FEATURES:

- Standard package 15 units per measurement and design.
- Per unit, ask about conditions.

MEDIDAS Y PESOS Dimensions and weights	
LARGO X ANCHO Length x width	PESO BANDA Bar weight
2850x0260x22 mm.	11,10 kg.
2850x0279x22 mm.	11,95 kg.
2850x0349x22 mm.	14,95 kg.
2850x0430x22 mm.	18,35 kg.
2850x0449x22 mm.	19,20 kg.
2850x0630x22 mm.	26,90 kg.
2850x0699x22 mm.	29,85 kg.
2850x0730x22 mm.	31,15 kg.
2850x0830x22 mm.	35,40 kg.
2850x0899x22 mm.	38,40 kg.
2850x0930x22 mm.	39,65 kg.
2850x1185x22 mm.	50,55 kg.

Dimensiones según diseño.
 Dimensions according to design.

DISEÑOS BANDA INTEGRADA "45°" 22 mm

22 mm designs "45°" integrated bar

REFERENCIA Reference	ANCHO Widht	CÓDIGO Code
Blanco Finlandia	260	24P0085
PEB-070 BRILLO	279	24P0002
	349	24P0003
	430	24P0086
	449	24P0004
	630	24P0087
	699	24P0005
	730	24P0088
	830	24P0089
	899	24P0006
	930	24P0090
	LARGO/Lenght 2850	1185

REFERENCIA Reference	ANCHO Widht	CÓDIGO Code
Crema	260	24P0092
PEB-071 BRILLO	279	24P0008
	349	24P0009
	430	24P0093
	449	24P0010
	630	24P0094
	699	24P0011
	730	24P0095
	830	24P0096
	899	24P0012
	930	24P0097
	LARGO/Lenght 2850	1185

REFERENCIA Reference	ANCHO Widht	CÓDIGO Code
Lava	260	24P0099
PEB-072 BRILLO	279	24P0014
	349	24P0015
	430	24P0100
	449	24P0016
	630	24P0101
	699	24P0017
	730	24P0102
	830	24P0103
	899	24P0018
	930	24P0104
	LARGO/Lenght 2850	1185

REFERENCIA Reference	ANCHO Widht	CÓDIGO Code
Gris oscuro	260	24P0106
PEB-073 BRILLO	279	24P0020
	349	24P0021
	430	24P0107
	449	24P0022
	630	24P0108
	699	24P0023
	730	24P0109
	830	24P0110
	899	24P0024
	930	24P0111
	LARGO/Lenght 2850	1185

REFERENCIA Reference	ANCHO Widht	CÓDIGO Code
Rojo cherry	260	24P0113
PEB-077 BRILLO	279	24P0026
	349	24P0027
	430	24P0114
	449	24P0028
	630	24P0115
	699	24P0029
	730	24P0116
	830	24P0117
	899	24P0030
	930	24P0118
	LARGO/Lenght 2850	1185

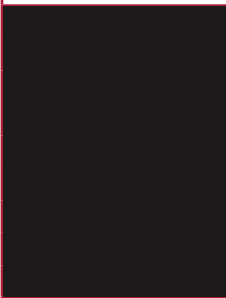
REFERENCIA Reference	ANCHO Widht	CÓDIGO Code
Negro Madagascar	260	24P0184
PEB-078 BRILLO	279	24P0185
	349	24P0186
	430	24P0187
	449	24P0188
	630	24P0189
	699	24P0190
	730	24P0191
	830	24P0192
	899	24P0193
	930	24P0194
	LARGO/Lenght 2850	1185

REFERENCIA Reference	ANCHO Widht	CÓDIGO Code
Café Latte	260	24P0120
PEB-080 BRILLO	279	24P0032
	349	24P0033
	430	24P0121
	449	24P0034
	630	24P0122
	699	24P0035
	730	24P0123
	830	24P0124
	899	24P0036
	930	24P0125
	LARGO/Lenght 2850	1185

REFERENCIA Reference	ANCHO Widht	CÓDIGO Code
Ceniza	260	24P0127
PEB-081 BRILLO	279	24P0038
	349	24P0039
	430	24P0128
	449	24P0040
	630	24P0129
	699	24P0041
	730	24P0130
	830	24P0131
	899	24P0042
	930	24P0132
	LARGO/Lenght 2850	1185

REFERENCIA Reference	ANCHO Widht	CÓDIGO Code
Burdeos teja	260	24P0210
PEB-085 BRILLO	279	24P0211
	349	24P0212
	430	24P0213
	449	24P0214
	630	24P0215
	699	24P0216
	730	24P0217
	830	24P0218
	899	24P0219
	930	24P0220
	LARGO/Lenght 2850	1185

REFERENCIA Reference	ANCHO Widht	CÓDIGO Code
Aguamarina urban	260	24P0223
PEB-086 BRILLO	279	24P0224
	349	24P0225
	430	24P0226
	449	24P0227
	630	24P0228
	699	24P0229
	730	24P0230
	830	24P0231
	899	24P0232
	930	24P0233
	LARGO/Lenght 2850	1185

REFERENCIA Reference	ANCHO Widht	CÓDIGO Code
Blanco Suecia	260	24P0262
PER-001 GRAIN	279	24P0263
	349	24P0264
	430	24P0265
	449	24P0266
	630	24P0267
	699	24P0268
	730	24P0269
	830	24P0270
	899	24P0271
	930	24P0272
	LARGO/Lenght 2850	1185

REFERENCIA Reference	ANCHO Widht	CÓDIGO Code
Arena Sahara	260	24P0275
PER-002 GRAIN	279	24P0276
	349	24P0277
	430	24P0278
	449	24P0279
	630	24P0280
	699	24P0281
	730	24P0282
	830	24P0283
	899	24P0284
	930	24P0285
	LARGO/Lenght 2850	1185

DISEÑOS BANDA INTEGRADA "45°" 22 mm

22 mm designs "45°" integrated bar

REFERENCIA Reference	ANCHO Widht	CÓDIGO Code
Gris Londres PER-003 GRAIN 	260	24P0288
	279	24P0289
	349	24P0290
	430	24P0291
	449	24P0292
	630	24P0293
	699	24P0294
	730	24P0295
	830	24P0296
	899	24P0297
930	24P0298	
LARGO / Lenght	2850	1185 24P0299

REFERENCIA Reference	ANCHO Widht	CÓDIGO Code
Bronce PEW-100 METALLIC 	260	24P0301
	279	24P0302
	349	24P0303
	430	24P0304
	449	24P0305
	630	24P0306
	699	24P0307
	730	24P0308
	830	24P0309
	899	24P0310
930	24P0311	
LARGO / Lenght	2850	1185 24P0312

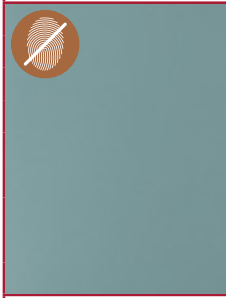
REFERENCIA Reference	ANCHO Widht	CÓDIGO Code
Aguamarina urban PEM-051 SP 	260	24P0236
	279	24P0237
	349	24P0238
	430	24P0239
	449	24P0240
	630	24P0241
	699	24P0242
	730	24P0243
	830	24P0244
	899	24P0245
930	24P0246	
LARGO / Lenght	2850	1185 24P0247

REFERENCIA Reference	ANCHO Widht	CÓDIGO Code
Burdeos teja PEM-052 SP 	260	24P0249
	279	24P0250
	349	24P0251
	430	24P0252
	449	24P0253
	630	24P0254
	699	24P0255
	730	24P0256
	830	24P0257
	899	24P0258
930	24P0259	
LARGO / Lenght	2850	1185 24P0260

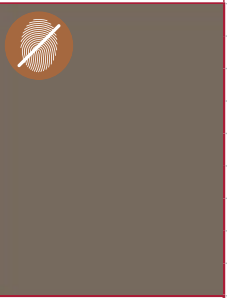
REFERENCIA Reference	ANCHO Widht	CÓDIGO Code
Cacao PEM-055 SP 	260	24P0134
	279	24P0044
	349	24P0045
	430	24P0135
	449	24P0046
	630	24P0136
	699	24P0047
	730	24P0137
	830	24P0138
	899	24P0048
930	24P0139	
LARGO / Lenght	2850	1185 24P0140

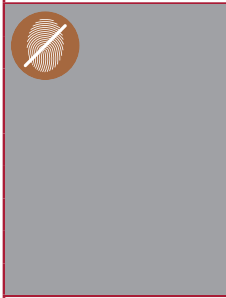
REFERENCIA Reference	ANCHO Widht	CÓDIGO Code
Ceniza PEM-056 SP 	260	24P0141
	279	24P0050
	349	24P0051
	430	24P0142
	449	24P0052
	630	24P0143
	699	24P0053
	730	24P0144
	830	24P0145
	899	24P0054
930	24P0146	
LARGO / Lenght	2850	1185 24P0147

REFERENCIA Reference	ANCHO Widht	CÓDIGO Code
Gris oscuro PEM-057 SP 	260	24P0148
	279	24P0056
	349	24P0057
	430	24P0149
	449	24P0058
	630	24P0150
	699	24P0059
	730	24P0151
	830	24P0152
	899	24P0060
930	24P0153	
LARGO / Lenght	2850	1185 24P0154

REFERENCIA Reference	ANCHO Widht	CÓDIGO Code
Café Latte PEM-058 SP 	260	24P0155
	279	24P0062
	349	24P0063
	430	24P0156
	449	24P0064
	630	24P0157
	699	24P0065
	730	24P0158
	830	24P0159
	899	24P0066
930	24P0160	
LARGO / Lenght	2850	1185 24P0161

REFERENCIA Reference	ANCHO Widht	CÓDIGO Code
Blanco Finlandia PEM-060 SP 	260	24P0162
	279	24P0068
	349	24P0069
	430	24P0163
	449	24P0070
	630	24P0164
	699	24P0071
	730	24P0165
	830	24P0166
	899	24P0072
930	24P0167	
LARGO / Lenght	2850	1185 24P0168

REFERENCIA Reference	ANCHO Widht	CÓDIGO Code
Capuchino PEM-061 SP 	260	24P0169
	279	24P0074
	349	24P0075
	430	24P0170
	449	24P0076
	630	24P0171
	699	24P0077
	730	24P0172
	830	24P0173
	899	24P0078
930	24P0174	
LARGO / Lenght	2850	1185 24P0175

REFERENCIA Reference	ANCHO Widht	CÓDIGO Code
Rojo cherry PEM-063 SP 	260	24P0176
	279	24P0080
	349	24P0081
	430	24P0177
	449	24P0082
	630	24P0178
	699	24P0083
	730	24P0179
	830	24P0180
	899	24P0084
930	24P0181	
LARGO / Lenght	2850	1185 24P0182

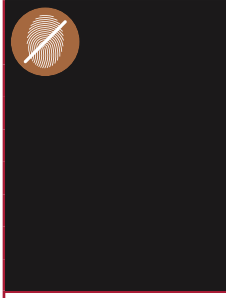
REFERENCIA Reference	ANCHO Widht	CÓDIGO Code
Negro Madagascar PEM-064 SP 	260	24P0197
	279	24P0198
	349	24P0199
	430	24P0200
	449	24P0201
	630	24P0202
	699	24P0203
	730	24P0204
	830	24P0205
	899	24P0206
930	24P0207	
LARGO / Lenght	2850	1185 24P0208

E.

top-collection



TABLERO

Board

■ CARACTERÍSTICAS TÉCNICAS:

Terminación: en recto.

Soporte: tablero aglomerado.

Recubrimiento: laminado decorativo HPL de 0,7 mm de espesor y film protector.

Contracara: idem, mismo color.

Adhesivo: cola PUR, poliuretano reactivo prensado en frío.

Espesor: 19 mm más laminado.

■ FEATURES:

Finish in straight.

Core: particle board.

Covering: 0.7 mm thick decorative HPL laminate and protective film.

Backside: Idem, same colour.

Adhesive: old press reactive polyurethane (PUR) glue.

Thickness: 19 mm plus laminate.

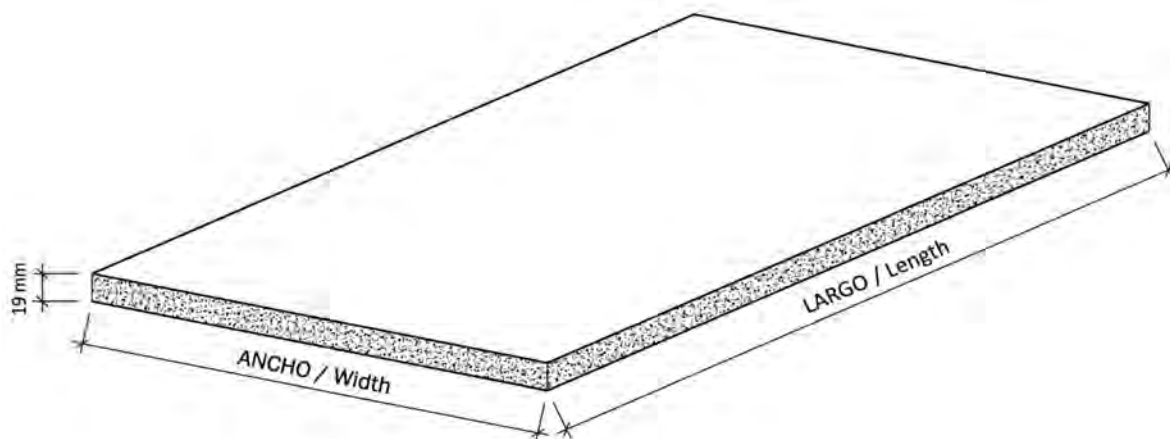
**■ CARACTERÍSTICAS TÉCNICAS:**

- Paquete estándar 10 unidades por medida y diseño.
- Por unidad, consultar condiciones.

■ FEATURES:

- Standard package 10 units per measurement and design.
- Per unit, ask about conditions.

MEDIDAS Y PESOS Dimensions and weights	
LARGO X ANCHO Length x width	PESO TABLERO Board weight
3600x1380x19 mm.	69,75 kg.
3600x1510x19 mm.	75,40 kg.

Dimensiones según diseño.
Dimensions according to design.

DISEÑOS TABLERO 19 mm

19 mm Designs board

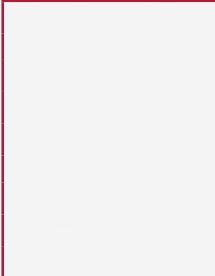
	REFERENCIA <i>Reference</i>
	Blanco Islandia 3091 SEF
	MEDIDA <i>Measure</i>
	3600x1380x19
CÓDIGO / <i>Code</i>	
3301735	

	REFERENCIA <i>Reference</i>
	Negro nieve 3306 BRILLO
	MEDIDA <i>Measure</i>
	3600x1380x19
CÓDIGO / <i>Code</i>	
3303764	

	REFERENCIA <i>Reference</i>
	Blanco nieve 3308 BRILLO
	MEDIDA <i>Measure</i>
	3600x1380x19
CÓDIGO / <i>Code</i>	
3303765	

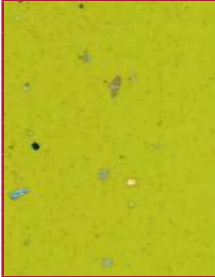
	REFERENCIA <i>Reference</i>
	Lima nieve 3309 BRILLO
	MEDIDA <i>Measure</i>
	3600x1380x19
CÓDIGO / <i>Code</i>	
3303766	

	REFERENCIA <i>Reference</i>
	Blanco antique nieve 3314 BRILLO
	MEDIDA <i>Measure</i>
	3600x1380x19
CÓDIGO / <i>Code</i>	
3303767	

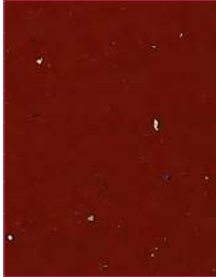
	REFERENCIA <i>Reference</i>
	Burdeos nieve 3315 BRILLO
	MEDIDA <i>Measure</i>
	3600x1380x19
CÓDIGO / <i>Code</i>	
3303768	

	REFERENCIA <i>Reference</i>
	Rojo nieve 3316 BRILLO
	MEDIDA <i>Measure</i>
	3600x1380x19
CÓDIGO / <i>Code</i>	
3303769	

	REFERENCIA <i>Reference</i>
	Gris metalizado 8001 TF
	MEDIDA <i>Measure</i>
	3600x1380x19
CÓDIGO / <i>Code</i>	
3303770	

	REFERENCIA <i>Reference</i>
	Annapurna lava ANA-043 ANNAPURN
	MEDIDA <i>Measure</i>
	3600x1380x19
CÓDIGO / <i>Code</i>	
3303676	

	REFERENCIA <i>Reference</i>
	Annapurna gris ANC-042 ANNAPURN
	MEDIDA <i>Measure</i>
	3600x1380x19
CÓDIGO / <i>Code</i>	
3303666	

	REFERENCIA <i>Reference</i>
	Annapurna grafito ANG-044 ANNAPURN
	MEDIDA <i>Measure</i>
	3600x1380x19
CÓDIGO / <i>Code</i>	
3303678	

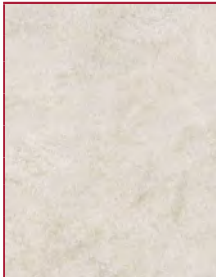
	REFERENCIA <i>Reference</i>
	Annapurna crema ANM-047 ANNAPURN
	MEDIDA <i>Measure</i>
	3600x1380x19
CÓDIGO / <i>Code</i>	
3302088	

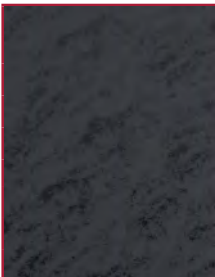
	REFERENCIA <i>Reference</i>
	Annapurna negro ANN-048 ANNAPURN
	MEDIDA <i>Measure</i>
	3600x1380x19
CÓDIGO / <i>Code</i>	
3303771	

	REFERENCIA <i>Reference</i>
	Marmol Calacatta CAL-800 FEEL
	MEDIDA <i>Measure</i>
	3600x1380x19
CÓDIGO / <i>Code</i>	
3303772	

	REFERENCIA <i>Reference</i>
	Tablillas CAT-178 SOFT
	MEDIDA <i>Measure</i>
	3600x1380x19
CÓDIGO / <i>Code</i>	
3303773	

	REFERENCIA <i>Reference</i>
	Cemento plata CEM-849 FEEL
	MEDIDA <i>Measure</i>
	3600x1380x19
CÓDIGO / <i>Code</i>	
3303774	

	REFERENCIA <i>Reference</i>
	Mineral Apollo DEA-843 OLYMPUS
	MEDIDA <i>Measure</i>
	3600x1380x19
CÓDIGO / <i>Code</i>	
3303775	

	REFERENCIA <i>Reference</i>
	Cantera Hermes DEN-841 OLYMPUS
	MEDIDA <i>Measure</i>
	3600x1380x19
CÓDIGO / <i>Code</i>	
3303776	

DISEÑOS TABLERO 19 mm

19 mm Designs board

	REFERENCIA Reference
	Mineral Zeus DEZ-842 OLYMPUS
	MEDIDA Measure
	3600x1380x19
CÓDIGO / Code	
3303761	

	REFERENCIA Reference
	Roble vintage EVE-801 FEEL
	MEDIDA Measure
	3600x1380x19
CÓDIGO / Code	
3302067	

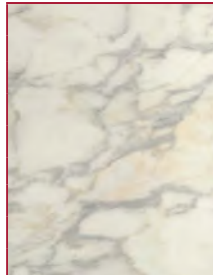
	REFERENCIA Reference
	Calacatta natural F-271 BRILLO
	MEDIDA Measure
	3600x1380x19
CÓDIGO / Code	
3303777	

	REFERENCIA Reference
	Granito negro F-281 BRILLO
	MEDIDA Measure
	3600x1380x19
CÓDIGO / Code	
3303778	

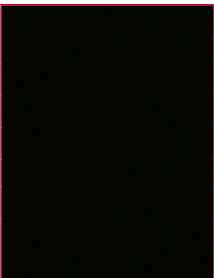
	REFERENCIA Reference
	Negro encerado GLP-283 ROCK
	MEDIDA Measure
	3600x1380x19
CÓDIGO / Code	
—	

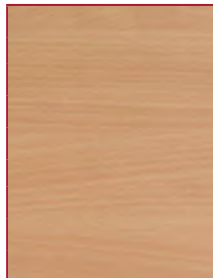
	REFERENCIA Reference
	Haya H-203 SOFT
	MEDIDA Measure
	3600x1380x19
CÓDIGO / Code	
3303779	

	REFERENCIA Reference
	Cacao maní INA-814 NDF
	MEDIDA Measure
	3600x1380x19
CÓDIGO / Code	
3303679	

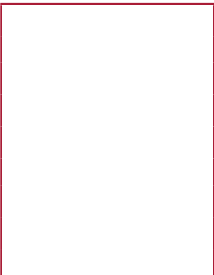
	REFERENCIA Reference
	Blanco Groenlandia INB-812 NDF
	MEDIDA Measure
	3600x1380x19
CÓDIGO / Code	
3301514	

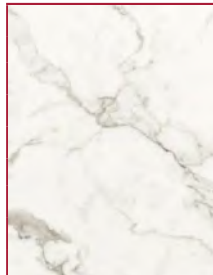
	REFERENCIA Reference
	Calacatta INC-818 NDF
	MEDIDA Measure
	3600x1380x19
CÓDIGO / Code	
3303683	

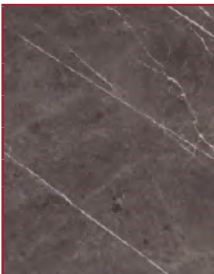
	REFERENCIA Reference
	Marquina gris INM-817 NDF
	MEDIDA Measure
	3600x1380x19
CÓDIGO / Code	
3303682	

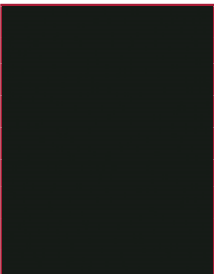
	REFERENCIA Reference
	Negro profundo INN-816 NDF
	MEDIDA Measure
	3600x1380x19
CÓDIGO / Code	
3303681	

	REFERENCIA Reference
	Café mokachino INP-813 NDF
	MEDIDA Measure
	3600x1380x19
CÓDIGO / Code	
3302293	

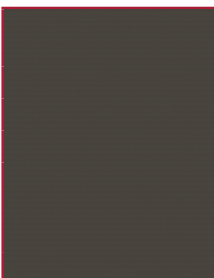
	REFERENCIA Reference
	Grafito INT-815 NDF
	MEDIDA Measure
	3600x1380x19
CÓDIGO / Code	
3303680	

	REFERENCIA Reference
	Arena duna KMM-740 WAX
	MEDIDA Measure
	3600x1380x19
CÓDIGO / Code	
—	

	REFERENCIA Reference
	Pino Talco LAR-770 SOFT
	MEDIDA Measure
	3600x1510x19
CÓDIGO / Code	
3301704	

	REFERENCIA Reference
	Mármol marquina MAC-820 STUCCO
	MEDIDA Measure
	3600x1380x19
CÓDIGO / Code	
3302107	

	REFERENCIA Reference
	Mármol emperador MAY-819 STUCCO
	MEDIDA Measure
	3600x1380x19
CÓDIGO / Code	
3302106	

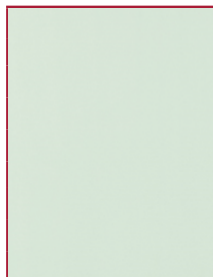
	REFERENCIA Reference
	Azul metálico MTA-768 BRILLO
	MEDIDA Measure
	3600x1380x19
CÓDIGO / Code	
3301626	

DISEÑOS TABLERO 19 mm

19 mm Designs board

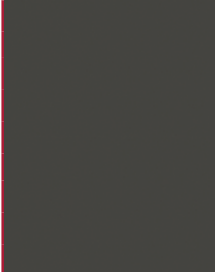
	REFERENCIA Reference
	Gris metálico MTG-765 BRILLO
	MEDIDA Measure
	3600x1380x19
CÓDIGO / Code	
3301630	

	REFERENCIA Reference
	Marquina NMN-744 BRILLO
	MEDIDA Measure
	3600x1380x19
CÓDIGO / Code	
3303780	

	REFERENCIA Reference
	Marmol paraíso OAS-278 STONE
	MEDIDA Measure
	3600x1380x19
CÓDIGO / Code	
3303781	

	REFERENCIA Reference
	Óxido azulado OXA-445 WAX
	MEDIDA Measure
	3600x1380x19
CÓDIGO / Code	
3301761	

	REFERENCIA Reference
	Óxido marrón OXM-444 WAX
	MEDIDA Measure
	3600x1380x19
CÓDIGO / Code	
3301703	

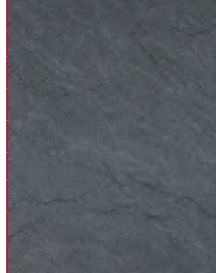
	REFERENCIA Reference
	Pizarra PIZ-224 SOFT
	MEDIDA Measure
	3600x1380x19
CÓDIGO / Code	
3303782	

	REFERENCIA Reference
	Granito salmón PP-5564 BRILLO
	MEDIDA Measure
	3600x1380x19
CÓDIGO / Code	
3303783	

	REFERENCIA Reference
	Granito labrador PP-5568 BRILLO
	MEDIDA Measure
	3600x1380x19
CÓDIGO / Code	
3303784	

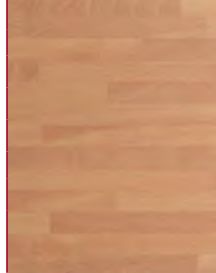
	REFERENCIA Reference
	Haya alistonada PP-7581 SOFT
	MEDIDA Measure
	3600x1380x19
CÓDIGO / Code	
3303785	

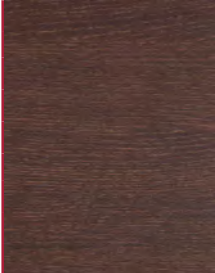
	REFERENCIA Reference
	Wengue PSF-143 SOFT
	MEDIDA Measure
	3600x1380x19
CÓDIGO / Code	
3303786	

	REFERENCIA Reference
	Granito gala RG-102 BRILLO
	MEDIDA Measure
	3600x1380x19
CÓDIGO / Code	
3303787	

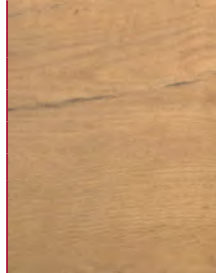
	REFERENCIA Reference
	Roble natural RON-803 OPEN PORE
	MEDIDA Measure
	3600x1510x19
CÓDIGO / Code	
3302230	

	REFERENCIA Reference
	Roble tostado ROS-804 OPEN PORE
	MEDIDA Measure
	3600x1510x19
CÓDIGO / Code	
3303665	

	REFERENCIA Reference
	Pizarra negra SLN-440 ROCK
	MEDIDA Measure
	3600x1380x19
CÓDIGO / Code	
3303788	

	REFERENCIA Reference
	Marquina elegant STE-848 TOUCH
	MEDIDA Measure
	3600x1380x19
CÓDIGO / Code	
3303789	

	REFERENCIA Reference
	Marmol Atenea STG-846 BRILLO
	MEDIDA Measure
	3600x1380x19
CÓDIGO / Code	
3303760	

	REFERENCIA Reference
	Marmol Onyx STM-847 BRILLO
	MEDIDA Measure
	3600x1380x19
CÓDIGO / Code	
3303790	

	REFERENCIA Reference
	Terrazo claro TEC-844 OLYMPUS
	MEDIDA Measure
	3600x1380x19
CÓDIGO / Code	
3303791	

DISEÑOS TABLERO 19 mm

19 mm Designs board

	REFERENCIA <i>Reference</i>
	Terrazo oscuro TEO-845 OLYMPUS
	MEDIDA <i>Measure</i>
	3600x1380x19
	CÓDIGO / <i>Code</i>
	3303792

	REFERENCIA <i>Reference</i>
	Travertino TRA-260 STONE
	MEDIDA <i>Measure</i>
	3600x1380x19
	CÓDIGO / <i>Code</i>
	3303793

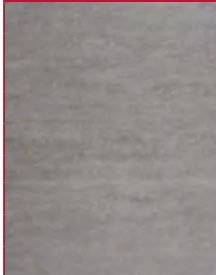
	REFERENCIA <i>Reference</i>
	Cemento TRC-443 WAX
	MEDIDA <i>Measure</i>
	3600x1380x19
	CÓDIGO / <i>Code</i>
	3301702

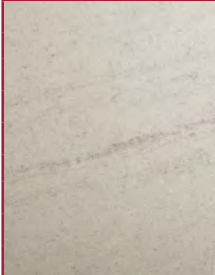
	REFERENCIA <i>Reference</i>
	Cemento claro VEC-773 WAX
	MEDIDA <i>Measure</i>
	3600x1380x19
	CÓDIGO / <i>Code</i>
	—

	REFERENCIA <i>Reference</i>
	Cemento oscuro VEO-774 WAX
	MEDIDA <i>Measure</i>
	3600x1380x19
	CÓDIGO / <i>Code</i>
	3301760

2. ENCIMERAS Y MOSTRADORES

Worktops and bartops



TOP FORM

A. top-collection

ENCIMERAS Y MOSTRADORES / Worktops and bartops



TOP FORM

ENCIMERA POSTFORMADA RADIO 3 mm / Postformed radius 3 mm worktop**■ CARACTERÍSTICAS TÉCNICAS:**

Terminación: postformado con radio 3 mm perfilado.

Espesor: 30/38 mm.

Soporte: tablero aglomerado con tratamiento estándar o hidrófugo.

Recubrimiento: laminado decorativo HPL de 0,7 mm de espesor y film protector.

Dorsal: acabado ECO o SUPRA.

Supra: junta de estanqueidad, canto trasero de protección y recubrimiento melamínico KRAFT.

Adhesivo para el plano: cola PVA (acetato de polivinilo).

Adhesivo para el postformado: poliamida.

Adhesivo para el canto (Supra): cola PUR, poliuretano reactivo prensado en frío.

■ FEATURES:

Finish: 3 mm radius postformed with profiling.

Thickness: 30/38 mm.

Core: particle board standard or moisture resistant treatment.

Covering: 0.7 mm thick decorative HPL laminate and protective film.

Back: ECO or SUPRA finish.

Supra: sealing joint, back edge protection and KRAFT melamine coating.

Flat adhesive: polyvinyl acetate PVA glue.

Postformed adhesive: polyamide.

Edge adhesive (Supra): old press reactive polyurethane (PUR) glue.

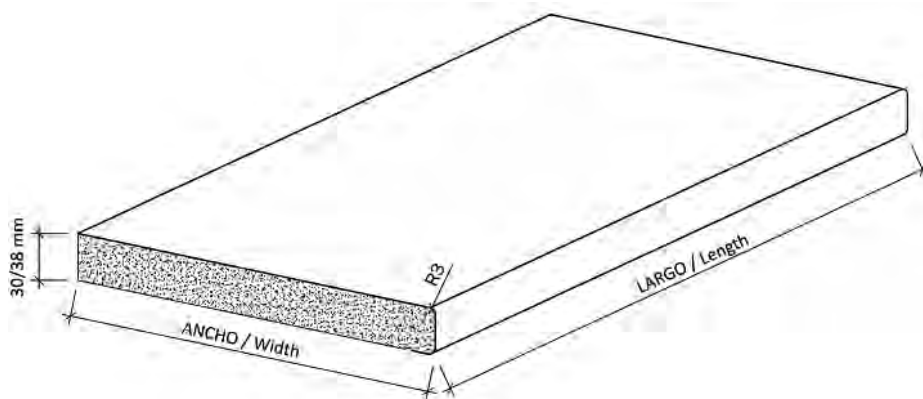
**■ CONDICIONES DE SUMINISTRO:**

- Paquete estándar 10 unidades por medida y diseño.
- Por unidad, consultar condiciones.

■ PURCHASING CONDITIONS:

- Standard package 10 units per measurement and design.
- Per unit, ask about conditions.

MEDIDAS Y PESOS Dimensions and weights	
LARGO X ANCHO Length x width	PESO ENCIMERA Worktop weight
3600x630x30 mm.	46,30 kg.
3600x620x38 mm.	60,70 kg.

ENCIMERA POSTFORMADA RADIO 8 mm / Postformed radius 8 mm worktop

■ CARACTERISTICAS TECNICAS:

Terminación: postformado con radio 8 mm perfilado.
Espesor: 30/38 mm.
Soporte: tablero aglomerado con tratamiento estándar o hidrófugo.
Recubrimiento: laminado decorativo HPL de 0,7 mm de espesor y film protector.
Dorsal: acabado ECO o SUPRA.
Supra: junta de estanqueidad, canto trasero de protección y recubrimiento melaminico KRAFT.
Adhesivo para el plano: cola PVA (acetato de polivinilo).
Adhesivo para el postformado: poliamida.
Adhesivo para el canto (Supra): cola PUR, poliuretano reactivo prensado en frío.



■ FEATURES:

Finish: 8 mm radius postformed with profiling.
Thickness: 30/38 mm.
Core: particle board standard or moisture resistant treatment.
Covering: 0.7 mm thick decorative HPL laminate and protective film.
Back: ECO or SUPRA finish.
Supra: sealing joint, back edge protection and KRAFT melamine coating.
Flat adhesive: polyvinyl acetate PVA glue.
Postformed adhesive: polyamide.
Edge adhesive (Supra): old press reactive polyurethane (PUR) glue.

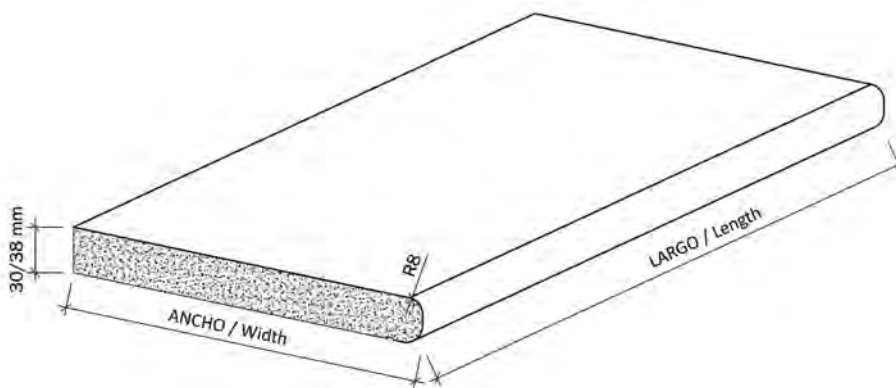

■ CONDICIONES DE SUMINISTRO:

- Paquete estándar 10 unidades por medida y diseño.
- Por unidad, consultar condiciones.

■ PURCHASING CONDITIONS:

- Standard package 10 units per measurement and design.
- Per unit, ask about conditions.

MEDIDAS Y PESOS Dimensions and weights	
LARGO X ANCHO Length x width	PESO ENCIMERA Worktop weight
3600x630x30 mm.	46,30 kg.
3600x620x38 mm.	60,70 kg.

ENCIMERA RECTA CANTEADA / Straight edged worktop**■ CARACTERÍSTICAS TÉCNICAS:**

Terminación: recto canteado.

Espesor: 30/38 mm.

Soporte: tablero aglomerado con tratamiento hidrófugo.

Recubrimiento: laminado decorativo HPL de 0,7 mm

de espesor y film protector.

Dorsal: acabado SUPRA.

Supra: junta de estanqueidad, canto trasero de protección y recubrimiento melamínico KRAFT.

Adhesivo para el plano: cola PVA (acetato de polivinilo).

Adhesivo para el canto: cola PUR, poliuretano reactivo prensado en frío.

■ FEATURES:

Finish: straight edged.

Thickness: 30/38 mm.

Core: particle board moisture resistant treatment.

Covering: 0.7 mm thick decorative HPL laminate and protective film.

Back: SUPRA finish.

Supra: sealing joint, back edge protection and KRAFT melamine coating.

Flat adhesive: polyvinyl acetate PVA glue.

Edge adhesive: old press reactive polyurethane (PUR) glue.

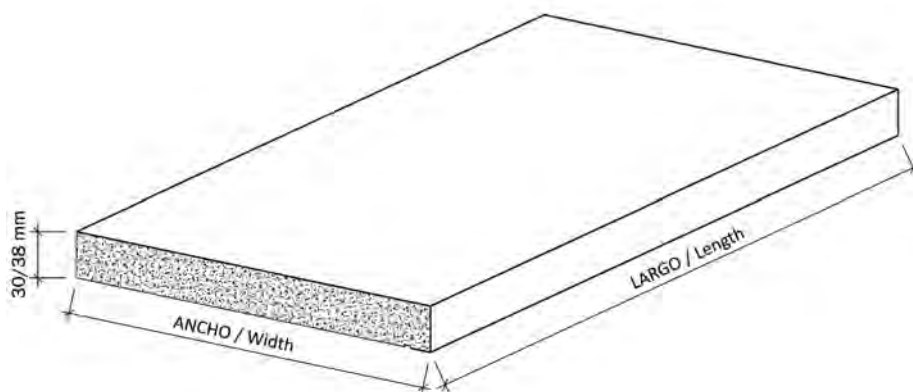
**■ CONDICIONES DE SUMINISTRO:**

- Paquete estándar 10 unidades por medida y diseño.
- Por unidad, consultar condiciones.

■ PURCHASING CONDITIONS:

- Standard package 10 units per measurement and design.
- Per unit, ask about conditions.

MEDIDAS Y PESOS <i>Dimensions and weights</i>	
LARGO X ANCHO <i>Length x width</i>	PESO ENCIMERA <i>Worktop weight</i>
3600x630x30 mm.	46,30 kg.
3600x620x38 mm.	60,70 kg.

MOSTRADOR POSTFORMADO RADIO 3 mm / Postformed radius 3 mm bartop

■ **CARACTERISTICAS TECNICAS:**

- Terminación: postformado con radio 3 mm perfilado.
- Espesor: 30/38 mm.
- Soporte: tablero aglomerado con tratamiento estándar.
- Recubrimiento: laminado decorativo HPL de 0,7 mm de espesor y film protector.
- Dorsal: acabado SUPRA.
- Supra: junta de estanqueidad y recubrimiento melaminico KRAFT.
- Adhesivo para el plano: cola PVA (acetato de polivinilo).
- Adhesivo para el postformado: poliamida.



■ **FEATURES:**

- Finish: 3 mm radius postformed with profiling.
- Thickness: 30/38 mm.
- Core: particle board standard treatment.
- Covering: 0.7 mm thick decorative HPL laminate and protective film.
- Back: SUPRA finish.
- Supra: sealing joint and KRAFT melamine coating.
- Flat adhesive: polyvinyl acetate PVA glue.
- Postformed adhesive: polyamide..

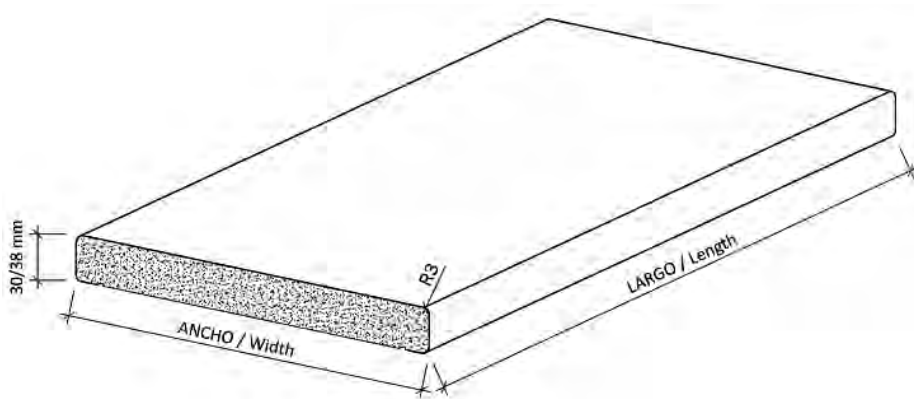

■ **CONDICIONES DE SUMINISTRO:**

- Por unidad.

■ **PURCHASING CONDITIONS:**

- Per unit.

MEDIDAS Y PESOS <i>Dimensions and weights</i>	
DIMENSIONES <i>Dimensions</i>	PESO MOSTRADOR <i>Bartop weight</i>
3600x(400→1240)x30 mm.	19,60 kg./m ²
3600x(400→1240)x38 mm.	24,70 kg./m ²

MOSTRADOR POSTFORMADO RADIO 8 mm / Postformed radius 8 mm bartop**■ CARACTERÍSTICAS TÉCNICAS:**

Terminación: postformado con radio 8 mm perfilado.
Espesor: 30/38 mm.
Soporte: tablero aglomerado con tratamiento estándar.
Recubrimiento: laminado decorativo HPL de 0,7 mm de espesor y film protector.
Dorsal: acabado SUPRA.
Supra: junta de estanqueidad y recubrimiento melaminico KRAFT.
Adhesivo para el plano: cola PVA (acetato de polivinilo).
Adhesivo para el postformado: poliamida.

**■ FEATURES:**

Finish: straight edged.
Thickness: 30/38 mm.
Core: particle board moisture resistant treatment.
Covering: 0.7 mm thick decorative HPL laminate and protective film.
Back: SUPRA finish.
Supra: sealing joint, back edge protection and KRAFT melamine coating.
Flat adhesive: polyvinyl acetate PVA glue.
Edge adhesive: old press reactive polyurethane (PUR) glue.

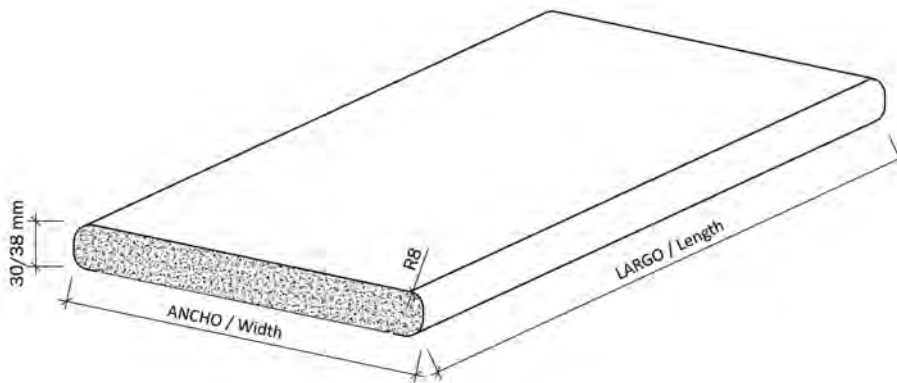
**■ CONDICIONES DE SUMINISTRO:**

- Por unidad.

■ PURCHASING CONDITIONS:

- Per unit.

MEDIDAS Y PESOS <i>Dimensions and weights</i>	
DIMENSIONES <i>Dimensions</i>	PESO MOSTRADOR <i>Bartop weight</i>
3600x(400→1240)x30 mm.	19,60 kg./m ²
3600x(400→1240)x38 mm.	24,70 kg./m ²

MOSTRADOR RECTO CANTEADO / Straight edged bartop

■ **CARACTERISTICAS TECNICAS:**

Terminación: recto canteado.

Espesor: 30/38 mm.

Soporte: tablero aglomerado con tratamiento estándar.

Recubrimiento: laminado decorativo HPL de 0,7 mm de espesor y film protector.

Dorsal: acabado SUPRA.

Supra: junta de estanqueidad y recubrimiento melaminico KRAFT.

Adhesivo para el plano: cola PVA (acetato de polivinilo).

Adhesivo para el canto: cola PUR, poliuretano reactivo prensado en frío.

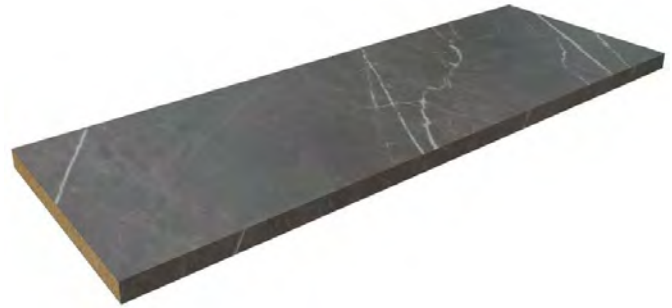

■ **FEATURES:**

Finish: straight edged.

Thickness: 30/38 mm.

Core: particle board standard treatment.

Covering: 0.7 mm thick decorative HPL laminate and protective film.

Back: SUPRA finish.

Supra: sealing joint and KRAFT melamine coating, melamine coating.

Flat adhesive: polyvinyl acetate PVA glue.

Edge adhesive: old press reactive polyurethane (PUR) glue.

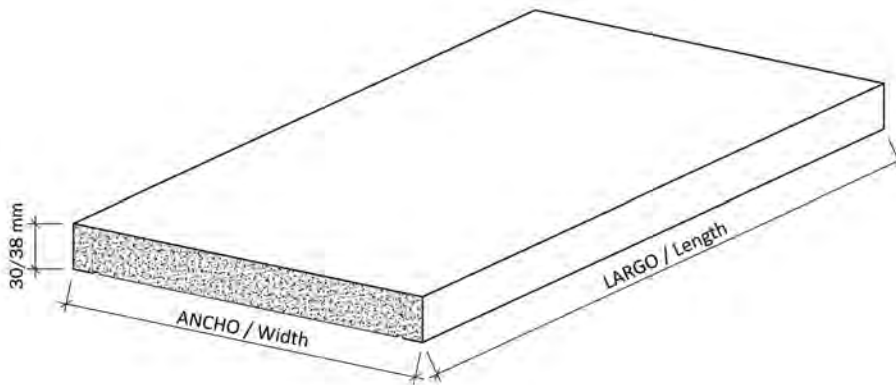

■ **CONDICIONES DE SUMINISTRO:**

- Por unidad.

■ **PURCHASING CONDITIONS:**

- Per unit.

MEDIDAS Y PESOS <i>Dimensions and weights</i>	
DIMENSIONES <i>Dimensions</i>	PESO MOSTRADOR <i>Bartop weight</i>
3600x(400→1240)x30 mm.	19,60 kg./m ²
3600x(400→1240)x38 mm.	24,70 kg./m ²

DISEÑOS ENCIMERAS Y MOSTRADORES / Worktops and bartops designs

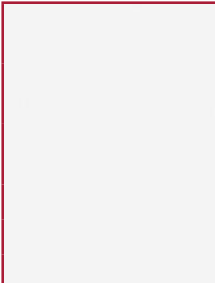
	REFERENCIA Reference
Blanco Islandia 3091 SEF	
FORMA Shape	
Radio / Radius 3 mm	
Radio / Radius 8 mm	
—	

	REFERENCIA Reference
Negro nieve 3306 BRILLO	
FORMA Shape	
Radio / Radius 3 mm	
—	
Recto / Straight	

	REFERENCIA Reference
Blanco nieve 3308 BRILLO	
FORMA Shape	
Radio / Radius 3 mm	
—	
Recto / Straight	

	REFERENCIA Reference
Lima nieve 3309 BRILLO	
FORMA Shape	
Radio / Radius 3 mm	
—	
Recto / Straight	

	REFERENCIA Reference
Blanco antique nieve 3314 BRILLO	
FORMA Shape	
Radio / Radius 3 mm	
—	
Recto / Straight	

	REFERENCIA Reference
Burdeos nieve 3315 BRILLO	
FORMA Shape	
Radio / Radius 3 mm	
—	
Recto / Straight	

	REFERENCIA Reference
Rojo nieve 3316 BRILLO	
FORMA Shape	
Radio / Radius 3 mm	
—	
Recto / Straight	

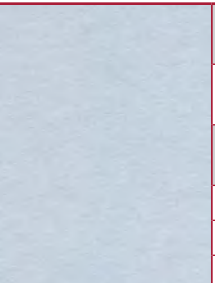
	REFERENCIA Reference
Gris metalizado 8001 TF	
FORMA Shape	
Radio / Radius 3 mm	
Radio / Radius 8 mm	
—	

	REFERENCIA Reference
Annapurna lava ANA-043 ANNAPURN	
FORMA Shape	
Radio / Radius 3 mm	
Radio / Radius 8 mm	
—	

	REFERENCIA Reference
Annapurna gris ANC-042 ANNAPURN	
FORMA Shape	
Radio / Radius 3 mm	
Radio / Radius 8 mm	
Recto / Straight	

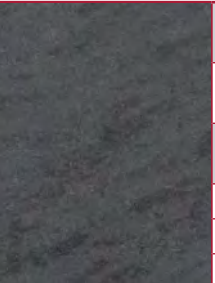
	REFERENCIA Reference
Annapurna grafito ANG-044 ANNAPURN	
FORMA Shape	
Radio / Radius 3 mm	
Radio / Radius 8 mm	
Recto / Straight	

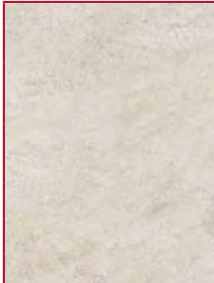
	REFERENCIA Reference
Annapurna crema ANM-047 ANNAPURN	
FORMA Shape	
Radio / Radius 3 mm	
Radio / Radius 8 mm	
—	

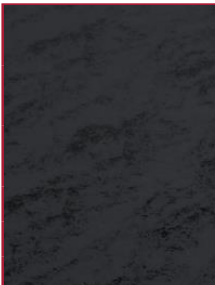
	REFERENCIA Reference
Annapurna negro ANN-048 ANNAPURN	
FORMA Shape	
Radio / Radius 3 mm	
Radio / Radius 8 mm	
—	

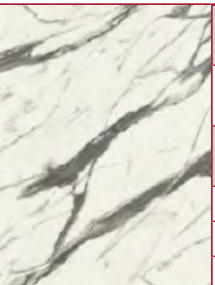
	REFERENCIA Reference
Marmol Calacatta CAL-800 FEEL	
FORMA Shape	
Radio / Radius 3 mm	
Radio / Radius 8 mm	
Recto / Straight	

	REFERENCIA Reference
Tablillas CAT-178 SOFT	
FORMA Shape	
Radio / Radius 3 mm	
Radio / Radius 8 mm	
—	

	REFERENCIA Reference
Cemento plata CEM-849 FEEL	
FORMA Shape	
Radio / Radius 3 mm	
Radio / Radius 8 mm	
—	

	REFERENCIA Reference
Mineral Apollo DEA-843 OLYMPUS	
FORMA Shape	
Radio / Radius 3 mm	
Radio / Radius 8 mm	
—	

	REFERENCIA Reference
Cantera Hermes DEN-841 OLYMPUS	
FORMA Shape	
Radio / Radius 3 mm	
Radio / Radius 8 mm	
—	

DISEÑOS ENCIMERAS Y MOSTRADORES / Worktops and bartops designs

	REFERENCIA Reference
	Mineral Zeus DEZ-842 OLYMPUS
	FORMA Shape
	Radio / Radius 3 mm
	Radio / Radius 8 mm
Recto / Straight	

	REFERENCIA Reference
	Roble vintage EVE-801 FEEL
	FORMA Shape
	Radio / Radius 3 mm
	Radio / Radius 8 mm
—	

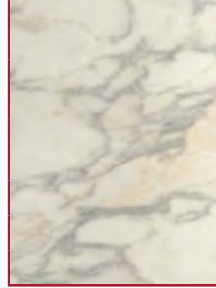
	REFERENCIA Reference
	Calacatta natural F-271 BRILLO
	FORMA Shape
	Radio / Radius 3 mm
	Radio / Radius 8 mm
—	

	REFERENCIA Reference
	Granito negro F-281 BRILLO
	FORMA Shape
	Radio / Radius 3 mm
	Radio / Radius 8 mm
—	

	REFERENCIA Reference
	Negro encerado GLP-283 ROCK
	FORMA Shape
	Radio / Radius 3 mm
	Radio / Radius 8 mm
Recto / Straight	

	REFERENCIA Reference
	Haya H-203 SOFT
	FORMA Shape
	Radio / Radius 3 mm
	Radio / Radius 8 mm
—	

	REFERENCIA Reference
	Cacao maní INA-814 NDF
	FORMA Shape
	Radio / Radius 3 mm
	Radio / Radius 8 mm
—	

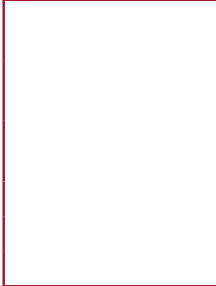
	REFERENCIA Reference
	Blanco Groenlandia INB-812 NDF
	FORMA Shape
	Radio / Radius 3 mm
	Radio / Radius 8 mm
—	

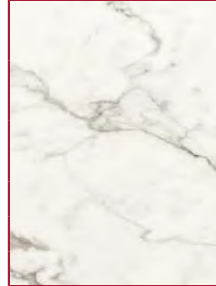
	REFERENCIA Reference
	Calacatta INC-818 NDF
	FORMA Shape
	Radio / Radius 3 mm
	Radio / Radius 8 mm
—	

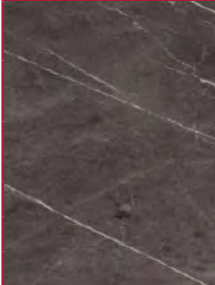
	REFERENCIA Reference
	Marquina gris INM-817 NDF
	FORMA Shape
	Radio / Radius 3 mm
	Radio / Radius 8 mm
—	

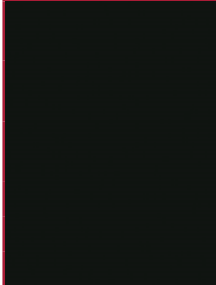
	REFERENCIA Reference
	Negro profundo INN-816 NDF
	FORMA Shape
	Radio / Radius 3 mm
	Radio / Radius 8 mm
—	

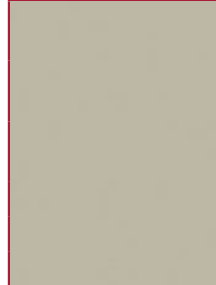
	REFERENCIA Reference
	Café mokachino INP-813 NDF
	FORMA Shape
	Radio / Radius 3 mm
	Radio / Radius 8 mm
Recto / Straight	

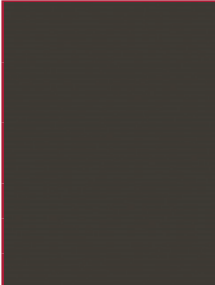
	REFERENCIA Reference
	Grafito INT-815 NDF
	FORMA Shape
	Radio / Radius 3 mm
	Radio / Radius 8 mm
Recto / Straight	

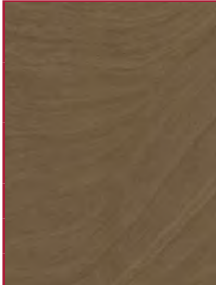
	REFERENCIA Reference
	Arena duna KMM-740 WAX
	FORMA Shape
	Radio / Radius 3 mm
	Radio / Radius 8 mm
Recto / Straight	

	REFERENCIA Reference
	Pino Talco LAR-770 SOFT
	FORMA Shape
	Radio / Radius 3 mm
	Radio / Radius 8 mm
—	

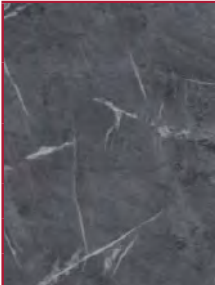
	REFERENCIA Reference
	Mármol marquina MAC-820 STUCCO
	FORMA Shape
	Radio / Radius 3 mm
	Radio / Radius 8 mm
—	

	REFERENCIA Reference
	Mármol emperador MAY-819 STUCCO
	FORMA Shape
	Radio / Radius 3 mm
	Radio / Radius 8 mm
—	

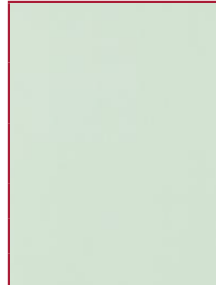
	REFERENCIA Reference
	Azul metálico MTA-768 BRILLO
	FORMA Shape
	Radio / Radius 3 mm
	Radio / Radius 8 mm
—	

DISEÑOS ENCIMERAS Y MOSTRADORES / Worktops and bartops designs

	REFERENCIA Reference
Gris metálico MTG-765 BRILLO	
FORMA Shape	
Radio / Radius 3 mm	
Radio / Radius 8 mm	
Recto / Straight	

	REFERENCIA Reference
Marquina NMN-744 BRILLO	
FORMA Shape	
Radio / Radius 3 mm	
Radio / Radius 8 mm	
—	

	REFERENCIA Reference
Marmol paraíso OAS-278 STONE	
FORMA Shape	
Radio / Radius 3 mm	
Radio / Radius 8 mm	
—	

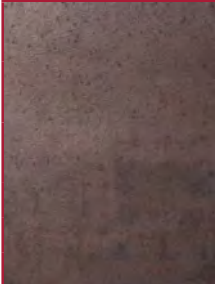
	REFERENCIA Reference
Óxido azulado OXA-445 WAX	
FORMA Shape	
Radio / Radius 3 mm	
Radio / Radius 8 mm	
—	

	REFERENCIA Reference
Óxido marrón OXM-444 WAX	
FORMA Shape	
Radio / Radius 3 mm	
Radio / Radius 8 mm	
Recto / Straight	

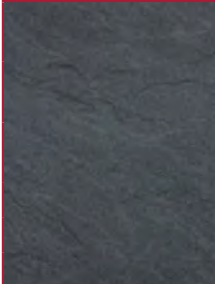
	REFERENCIA Reference
Pizarra PIZ-224 SOFT	
FORMA Shape	
Radio / Radius 3 mm	
Radio / Radius 8 mm	
—	

	REFERENCIA Reference
Granito salmón PP-5564 BRILLO	
FORMA Shape	
Radio / Radius 3 mm	
Radio / Radius 8 mm	
—	

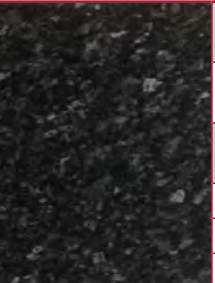
	REFERENCIA Reference
Granito labrador PP-5568 BRILLO	
FORMA Shape	
Radio / Radius 3 mm	
Radio / Radius 8 mm	
—	

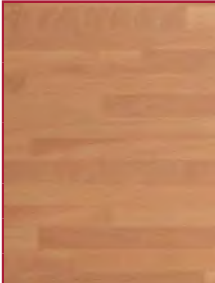
	REFERENCIA Reference
Haya alistonada PP-7581 SOFT	
FORMA Shape	
Radio / Radius 3 mm	
Radio / Radius 8 mm	
—	

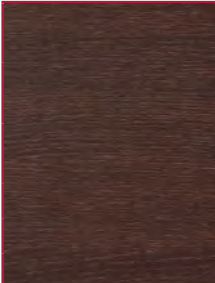
	REFERENCIA Reference
Wengue PSF-143 SOFT	
FORMA Shape	
Radio / Radius 3 mm	
Radio / Radius 8 mm	
—	

	REFERENCIA Reference
Granito gala RG-102 BRILLO	
FORMA Shape	
Radio / Radius 3 mm	
Radio / Radius 8 mm	
—	

	REFERENCIA Reference
Roble natural RON-803 OPEN PORE	
FORMA Shape	
Radio / Radius 3 mm	
Radio / Radius 8 mm	
Recto / Straight	

	REFERENCIA Reference
Roble tostado ROS-804 OPEN PORE	
FORMA Shape	
Radio / Radius 3 mm	
Radio / Radius 8 mm	
Recto / Straight	

	REFERENCIA Reference
Pizarra negra SLN-440 ROCK	
FORMA Shape	
Radio / Radius 3 mm	
Radio / Radius 8 mm	
Recto / Straight	

	REFERENCIA Reference
Marquina elegant STE-848 TOUCH	
FORMA Shape	
Radio / Radius 3 mm	
Radio / Radius 8 mm	
—	

	REFERENCIA Reference
Marmol Atenea STG-846 BRILLO	
FORMA Shape	
Radio / Radius 3 mm	
Radio / Radius 8 mm	
—	

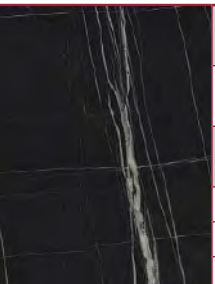
	REFERENCIA Reference
Marmol Onyx STM-847 BRILLO	
FORMA Shape	
Radio / Radius 3 mm	
Radio / Radius 8 mm	
—	

	REFERENCIA Reference
Terrazo claro TEC-844 OLYMPUS	
FORMA Shape	
Radio / Radius 3 mm	
Radio / Radius 8 mm	
—	

DISEÑOS ENCIMERAS Y MOSTRADORES / Worktops and bartops designs

	REFERENCIA <i>Reference</i>
	Terrazo oscuro TEO-845 OLYMPUS
	FORMA <i>Shape</i>
	Radio / <i>Radius</i> 3 mm
	Radio / <i>Radius</i> 8 mm
—	

	REFERENCIA <i>Reference</i>
	Travertino TRA-260 STONE
	FORMA <i>Shape</i>
	Radio / <i>Radius</i> 3 mm
	Radio / <i>Radius</i> 8 mm
—	

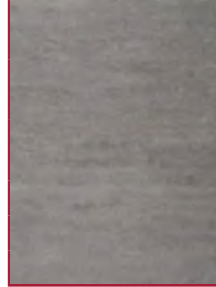
	REFERENCIA <i>Reference</i>
	Cemento TRC-443 WAX
	FORMA <i>Shape</i>
	Radio / <i>Radius</i> 3 mm
	Radio / <i>Radius</i> 8 mm
—	

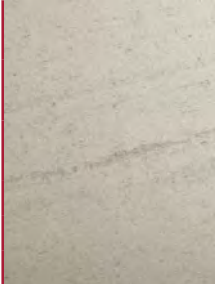
	REFERENCIA <i>Reference</i>
	Cemento claro VEC-773 WAX
	FORMA <i>Shape</i>
	Radio / <i>Radius</i> 3 mm
	Radio / <i>Radius</i> 8 mm
—	

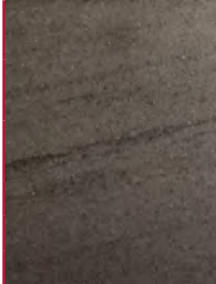
	REFERENCIA <i>Reference</i>
	Cemento oscuro VEO-774 WAX
	FORMA <i>Shape</i>
	Radio / <i>Radius</i> 3 mm
	Radio / <i>Radius</i> 8 mm
—	

B.



TOP FORM

ENCIMERA POSTFORMADA RADIO 3 mm / Postformed radius 3 mm worktop**■ CARACTERÍSTICAS TÉCNICAS:**

Terminación: postformado con radio 3 mm perfilado.

Espesor: 38 mm.

Soporte: tablero aglomerado con tratamiento hidrófugo.

Recubrimiento: laminado decorativo HPL de 0,7 mm de espesor y film protector.

Dorsal: acabado SUPRA.

Supra: junta de estanqueidad, canto trasero de protección y recubrimiento melaminico KRAFT.

Adhesivo para el plano: cola PVA (acetato de polivinilo).

Adhesivo para el postformado: poliamida.

Adhesivo para el canto (Supra): cola PUR, poliuretano reactivo prensado en frío.

Incluye 2 tiras de laminado para canto.

**■ FEATURES:**

Finish: 3 mm radius postformed with profiling.

Thickness: 38 mm.

Core: particle board moisture resistant treatment.

Covering: 0.7 mm thick decorative HPL laminate and protective film.

Back: SUPRA finish.

Supra: sealing joint, back edge protection and KRAFT melamine coating.

Flat adhesive: polyvinyl acetate PVA glue.

Postformed adhesive: polyamide.

Edge adhesive (Supra): old press reactive polyurethane (PUR) glue.

Includes 2 strips of laminate for edge.

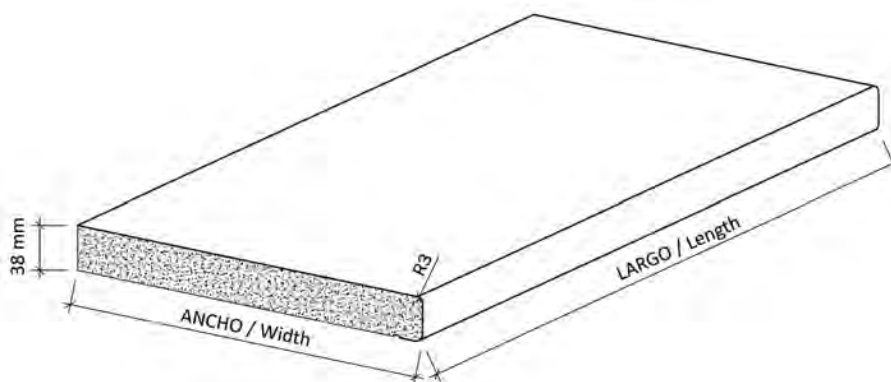
**■ CONDICIONES DE SUMINISTRO:**

- Por unidad retractilada.

■ PURCHASING CONDITIONS:

- Per shrink-wrapped unit.

MEDIDAS Y PESOS Dimensions and weights	
LARGO X ANCHO Length x width	PESO ENCIMERA Worktop weight
3600x620x38 mm.	60,70 kg.

MOSTRADOR POSTFORMADO RADIO 3 mm / Postformed radius 3 mm bartop

■ **CARACTERISTICAS TECNICAS:**

- Terminación:** postformado con radio 3 mm perfilado.
- Espesor:** 38 mm.
- Soporte:** tablero aglomerado con tratamiento estándar.
- Recubrimiento:** laminado decorativo HPL de 0,7 mm de espesor y film protector.
- Dorsal:** acabado SUPRA.
- Supra:** junta de estanqueidad y recubrimiento melaminico KRAFT.
- Adhesivo para el plano:** cola PVA (acetato de polivinilo).
- Adhesivo para el postformado:** poliamida.
- Incluye 2 tiras de laminado para canto.**



■ **FEATURES:**

- Finish:** 3 mm radius postformed with profiling.
- Thickness:** 38 mm.
- Core:** particle board standard treatment.
- Covering:** 0.7 mm thick decorative HPL laminate and protective film.
- Back:** SUPRA finish.
- Supra:** sealing joint and KRAFT melamine coating.
- Flat adhesive:** polyvinyl acetate PVA glue.
- Postformed adhesive:** polyamide.
- Includes 2 strips of laminate for edge.**

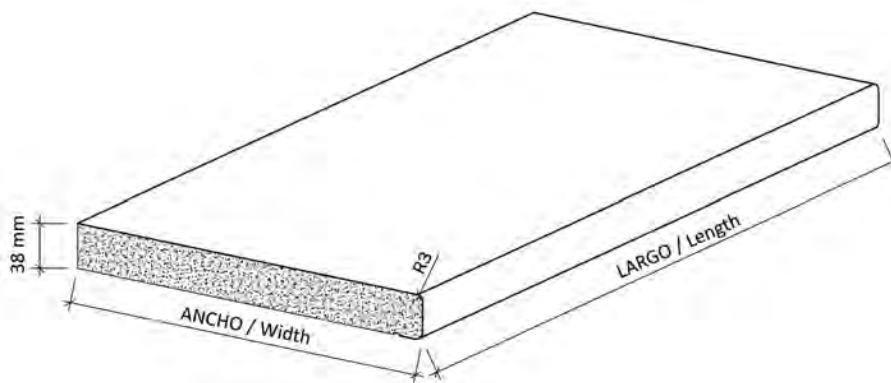

■ **CONDICIONES DE SUMINISTRO:**

- Por unidad retractilada.

■ **PURCHASING CONDITIONS:**

- Per shrink-wrapped unit.

MEDIDAS Y PESOS <i>Dimensions and weights</i>	
LARGO X ANCHO <i>Length x width</i>	PESO ENCIMERA <i>Worktop weight</i>
3600x650x38 mm.	63,70 kg.
3600x900x38 mm.	88,20 kg.

COPETE LAMINADO / Laminate worktop ending**■ CARACTERISTICAS TECNICAS:**

Dimensiones: 3600x80x19 mm. Terminación en recto canteado los dos largos

Soporte: tablero aglomerado con tratamiento estándar.

Recubrimiento: laminado decorativo HPL de 0,7 mm de espesor.

Adhesivo: cola PUR, poliuretano reactivo prensado en frio.

Incluye 2 tiras de laminado para canto. Suministro: por unidad retractilada.

■ FEATURES:

Dimensions: 3600x80x19 mm. Termination: straight edged both lengths.

Core: particle board standard treatment.

Covering: 0.7 mm thick decorative HPL laminate and protective film.

Adhesive: old press reactive polyurethane (PUR) glue.

**BACKSPLASH LAMINADO / Laminate backsplash****■ CARACTERISTICAS TECNICAS:**

Dimensiones: 3600x650x19 mm. Terminación en recto canteado los dos largos

Soporte: tablero aglomerado con tratamiento estándar.

Recubrimiento: laminado decorativo HPL de 0,7 mm de espesor.

Adhesivo: cola PUR, poliuretano reactivo prensado en frio.

Incluye 2 tiras de laminado para canto. Suministro: por unidad retractilada.

■ FEATURES:

Dimensions: 3600x650x19 mm. Termination: straight edged both lengths.

Core: particle board standard treatment.

Covering: 0.7 mm thick decorative HPL laminate and protective film.

Adhesive: old press reactive polyurethane (PUR) glue.

Includes 2 strips of laminate for edge. Supply: by shrink-wrapped unit..

**SELLADOR PARA JUNTAS / Sealing for joints****■ CARACTERISTICAS TECNICAS:**

Sellador para juntas del mismo color al diseño de la encimera.

Suministro: embase Colorfill 25 grs.

■ FEATURES:

Joint sealer of the same color to the worktop design.

Supply: 25 grs Colorfill canister.

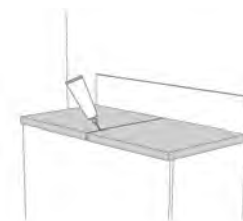
**COPETE UNIÓN PANEL LAMINADO / Laminate panel countertop edging****■ CARACTERISTICAS TECNICAS:**

Copete unión con junta de estanqueidad para panel laminado de 19 mm espesor.

Los accesorios de terminación, se tienen que pedir por separado.

Presentación: tira de 4500 mm. Acabado inox.

■ FEATURES:

Countertop edging for laminated panel 19 mm thick.

Termination accessories must be ordered separately.

Presentation: 4500 mm strip. Stainless finish.

DESCRIPCION Description	CODIGO Code
Copete unión tira 4500 mm / Countertop edging 4500 mm	9909209
Kit tapas laterales / Side cover kit	9909210

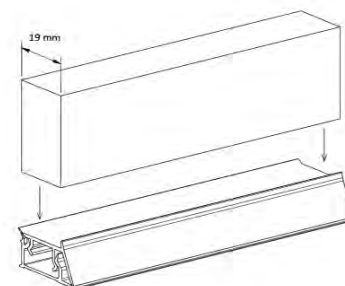

DISEÑOS ENCIMERAS, MOSTRADORES Y COMPLEMENTOS

Worktops, bartops and complements designs

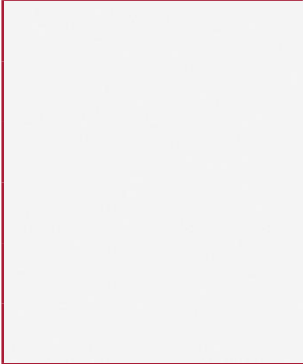
Blanco Islandia 3091 SEF	REFERENCIA Reference	CODIGO Code
	ENCIMERA Worktop	9909083
	MOSTRADOR 650 Bartop 650 mm.	9909165
	MOSTRADOR 900 Bartop 900 mm.	9909166
	COPETE Worktop ending	9909118
	BACKSPASH Backsplash	9909105
	SELLADOR Sealing for joints	9904167

Annapurna crema ANM-047 ANNAPURNA	REFERENCIA Reference	CODIGO Code
	ENCIMERA Worktop	9909098
	MOSTRADOR 650 Bartop 650 mm.	9909195
	MOSTRADOR 900 Bartop 900 mm.	9909196
	COPETE Worktop ending	9909118
	BACKSPASH Backsplash	9909105
	SELLADOR Sealing for joints	9904170

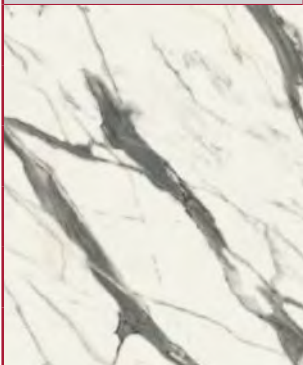
Marmol Calacatta CAL-800 FEEL	REFERENCIA Reference	CODIGO Code
	ENCIMERA Worktop	9909100
	MOSTRADOR 650 Bartop 650 mm.	9909199
	MOSTRADOR 900 Bartop 900 mm.	9909200
	COPETE Worktop ending	9909124
	BACKSPASH Backsplash	9909111
	SELLADOR Sealing for joints	9904180

Tablillas CAT-178 SOFT	REFERENCIA Reference	CODIGO Code
	ENCIMERA Worktop	9909084
	MOSTRADOR 650 Bartop 650 mm.	9909167
	MOSTRADOR 900 Bartop 900 mm.	9909168
	COPETE Worktop ending	9909125
	BACKSPASH Backsplash	9909112
	SELLADOR Sealing for joints	9904199

Mineral Apollo DEA-843 OLYMPUS	REFERENCIA Reference	CODIGO Code
	ENCIMERA Worktop	9910671
	MOSTRADOR 650 Bartop 650 mm.	9910677
	MOSTRADOR 900 Bartop 900 mm.	9910678
	COPETE Worktop ending	9910706
	BACKSPASH Backsplash	9910704
	SELLADOR Sealing for joints	9904192

Negro encerado GLP-283 ROCK	REFERENCIA Reference	CODIGO Code
	ENCIMERA Worktop	9909085
	MOSTRADOR 650 Bartop 650 mm.	9909169
	MOSTRADOR 900 Bartop 900 mm.	9909170
	COPETE Worktop ending	9909123
	BACKSPASH Backsplash	9909110
	SELLADOR Sealing for joints	9904188

Cacao maní INA-814 NDF	REFERENCIA Reference	CODIGO Code
	ENCIMERA Worktop	9910514
	MOSTRADOR 650 Bartop 650 mm.	9910521
	MOSTRADOR 900 Bartop 900 mm.	9910528
	COPETE Worktop ending	9910542
	BACKSPASH Backsplash	9910535
	SELLADOR Sealing for joints	9904189

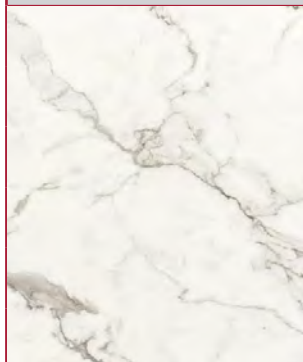
Calacatta INC-818 NDF	REFERENCIA Reference	CODIGO Code
	ENCIMERA Worktop	9910518
	MOSTRADOR 650 Bartop 650 mm.	9910525
	MOSTRADOR 900 Bartop 900 mm.	9910532
	COPETE Worktop ending	9910546
	BACKSPASH Backsplash	9910539
	SELLADOR Sealing for joints	9904180

DISEÑOS ENCIMERAS, MOSTRADORES Y COMPLEMENTOS

Worktops, bartops and complements designs

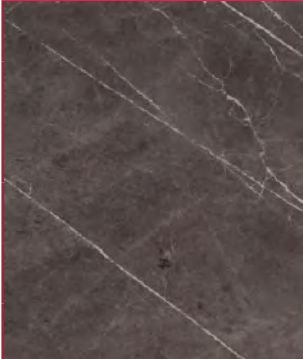
Marquina gris INN-817 NDF	REFERENCIA Reference	CODIGO Code
	ENCIMERA Worktop	9910517
	MOSTRADOR 650 Bartop 650 mm.	9910524
	MOSTRADOR 900 Bartop 900 mm.	9910531
	COPETE Worktop ending	9910545
	BACKSPLASH Backsplash	9910538
	SELLADOR Sealing for joints	9904192

Negro profundo INN-816 NDF	REFERENCIA Reference	CODIGO Code
	ENCIMERA Worktop	9910516
	MOSTRADOR 650 Bartop 650 mm.	9910523
	MOSTRADOR 900 Bartop 900 mm.	9910530
	COPETE Worktop ending	9910544
	BACKSPLASH Backsplash	9910537
	SELLADOR Sealing for joints	9904188

Café mokachino INP-813 NDF	REFERENCIA Reference	CODIGO Code
	ENCIMERA Worktop	9910513
	MOSTRADOR 650 Bartop 650 mm.	9910520
	MOSTRADOR 900 Bartop 900 mm.	9910527
	COPETE Worktop ending	9910541
	BACKSPLASH Backsplash	9910534
	SELLADOR Sealing for joints	9904185

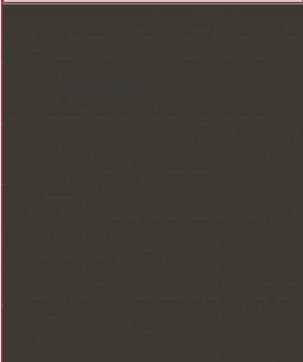
Grafito INT-815 NDF	REFERENCIA Reference	CODIGO Code
	ENCIMERA Worktop	9910515
	MOSTRADOR 650 Bartop 650 mm.	9910522
	MOSTRADOR 900 Bartop 900 mm.	9910529
	COPETE Worktop ending	9910543
	BACKSPLASH Backsplash	9910536
	SELLADOR Sealing for joints	9904182

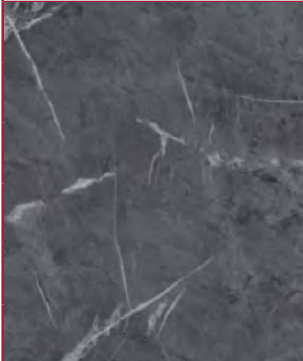
Mármol marquina MAC-820 STUCCO	REFERENCIA Reference	CODIGO Code
	ENCIMERA Worktop	9909437
	MOSTRADOR 650 Bartop 650 mm.	9909462
	MOSTRADOR 900 Bartop 900 mm.	9909463
	COPETE Worktop ending	9909454
	BACKSPLASH Backsplash	9909446
	SELLADOR Sealing for joints	9904173

Mármol emperador MAY-819 STUCCO	REFERENCIA Reference	CODIGO Code
	ENCIMERA Worktop	9909438
	MOSTRADOR 650 Bartop 650 mm.	9909464
	MOSTRADOR 900 Bartop 900 mm.	9909465
	COPETE Worktop ending	9909454
	BACKSPLASH Backsplash	9909446
	SELLADOR Sealing for joints	9904192

Marquina NMN-744 BRILLO	REFERENCIA Reference	CODIGO Code
	ENCIMERA Worktop	9909102
	MOSTRADOR 650 Bartop 650 mm.	9909203
	MOSTRADOR 900 Bartop 900 mm.	9909204
	COPETE Worktop ending	9909123
	BACKSPLASH Backsplash	9909110
	SELLADOR Sealing for joints	9904188

Óxido marrón OXM-444 WAX	REFERENCIA Reference	CODIGO Code
	ENCIMERA Worktop	9909088
	MOSTRADOR 650 Bartop 650 mm.	9909175
	MOSTRADOR 900 Bartop 900 mm.	9909176
	COPETE Worktop ending	9909119
	BACKSPLASH Backsplash	9909106
	SELLADOR Sealing for joints	9904183

DISEÑOS ENCIMERAS, MOSTRADORES Y COMPLEMENTOS

Worktops, bartops and complements designs

Roble natural RON-803 OPEN PORE	REFERENCIA <i>Reference</i>	CODIGO <i>Code</i>
	ENCIMERA <i>Worktop</i>	9909103
	MOSTRADOR 650 <i>Bartop 650 mm.</i>	9909205
	MOSTRADOR 900 <i>Bartop 900 mm.</i>	9909206
	COPETE <i>Worktop ending</i>	9909120
	BACKSPLASH <i>Backsplash</i>	9909107
	SELLADOR <i>Sealing for joints</i>	9908868

Roble tostado ROS-804 OPEN PORE	REFERENCIA <i>Reference</i>	CODIGO <i>Code</i>
	ENCIMERA <i>Worktop</i>	9909104
	MOSTRADOR 650 <i>Bartop 650 mm.</i>	9909207
	MOSTRADOR 900 <i>Bartop 900 mm.</i>	9909208
	COPETE <i>Worktop ending</i>	9909120
	BACKSPLASH <i>Backsplash</i>	9909107
	SELLADOR <i>Sealing for joints</i>	9904199

Marmol Atenea STG-846 BRILLO	REFERENCIA <i>Reference</i>	CODIGO <i>Code</i>
	ENCIMERA <i>Worktop</i>	9910670
	MOSTRADOR 650 <i>Bartop 650 mm.</i>	9910675
	MOSTRADOR 900 <i>Bartop 900 mm.</i>	9910676
	COPETE <i>Worktop ending</i>	9910705
	BACKSPLASH <i>Backsplash</i>	9910703
	SELLADOR <i>Sealing for joints</i>	9904184

Marmol Onyx STM-847 BRILLO	REFERENCIA <i>Reference</i>	CODIGO <i>Code</i>
	ENCIMERA <i>Worktop</i>	9910669
	MOSTRADOR 650 <i>Bartop 650 mm.</i>	9910673
	MOSTRADOR 900 <i>Bartop 900 mm.</i>	9910674
	COPETE <i>Worktop ending</i>	9910705
	BACKSPLASH <i>Backsplash</i>	9910703
	SELLADOR <i>Sealing for joints</i>	9904188

Terrazo oscuro TEO-845 OLYMPUS	REFERENCIA <i>Reference</i>	CODIGO <i>Code</i>
	ENCIMERA <i>Worktop</i>	9910672
	MOSTRADOR 650 <i>Bartop 650 mm.</i>	9910679
	MOSTRADOR 900 <i>Bartop 900 mm.</i>	9910680
	COPETE <i>Worktop ending</i>	9910706
	BACKSPLASH <i>Backsplash</i>	9910704
	SELLADOR <i>Sealing for joints</i>	9904189

Cemento TRC-443 WAX	REFERENCIA <i>Reference</i>	CODIGO <i>Code</i>
	ENCIMERA <i>Worktop</i>	9909086
	MOSTRADOR 650 <i>Bartop 650 mm.</i>	9909171
	MOSTRADOR 900 <i>Bartop 900 mm.</i>	9909172
	COPETE <i>Worktop ending</i>	9909126
	BACKSPLASH <i>Backsplash</i>	9909113
	SELLADOR <i>Sealing for joints</i>	9904202

C.

union **hpl**



TOP FORM

ENCIMERA RECTA CANTEADA / Straight edged worktop**■ CARACTERÍSTICAS TÉCNICAS:**

Terminación: recto canteado.

Espesor: 38 mm.

Soporte: tablero aglomerado con tratamiento hidrófugo.

Recubrimiento: laminado decorativo HPL de 0,7 mm de espesor y film protector.

Dorsal: acabado SUPRA.

Supra: junta de estanqueidad, canto trasero de protección y recubrimiento melaminico KRAFT.

Adhesivo para el plano: cola PVA (acetato de polivinilo).

Adhesivo para el canto: cola PUR, poliuretano reactivo prensado en frío.

■ FEATURES:

Finish: straight edged.

Thickness: 38 mm.

Core: particle board moisture resistant treatment.

Covering: 0.7 mm thick decorative HPL laminate and protective film.

Back: SUPRA finish.

Supra: sealing joint, back edge protection and KRAFT melamine coating.

Flat adhesive: polyvinyl acetate PVA glue.

Edge adhesive: old press reactive polyurethane (PUR) glue.

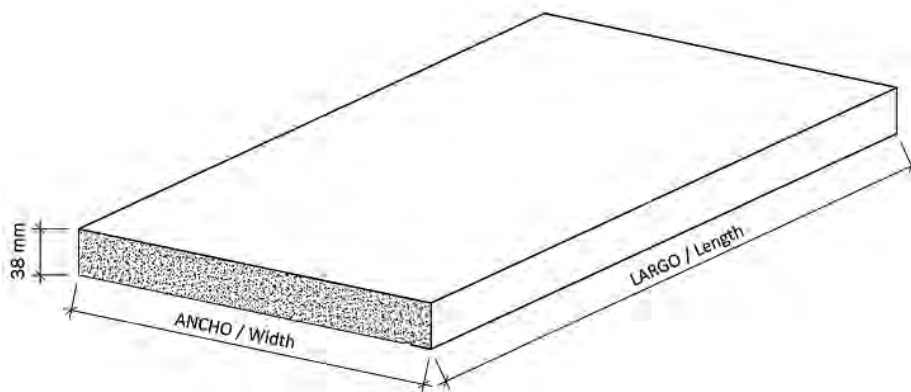
**■ CONDICIONES DE SUMINISTRO:**

- Paquete estándar 10 unidades por medida y diseño.

■ PURCHASING CONDITIONS:

- Standard package 10 units per measurement and design.

MEDIDAS Y PESOS <i>Dimensions and weights</i>	
LARGO x ANCHO <i>Length x width</i>	PESO ENCIMERA <i>Worktop weight</i>
1780x620x38 mm.	30,10 kg.
3580x620x38 mm.	60,30 kg.

ENCIMERA RECTA MECANIZADO DERECHO / Right machined worktop

■ CARACTERISTICAS TECNICAS:

Esquema encimeras mecanizadas derecho con terminación recto canteado.
 Medidas: 3580x620x380 mm + 1780x620x38 mm.
 Tira de laminado para cantos (3600x45 mm) no incluida.

■ FEATURES:

Right machined worktops diagram with termination straight edged.
 Measurements: 3580x620x380 mm + 1780x620x38 mm.
 Laminate edge strip (3600x45 mm) not included.

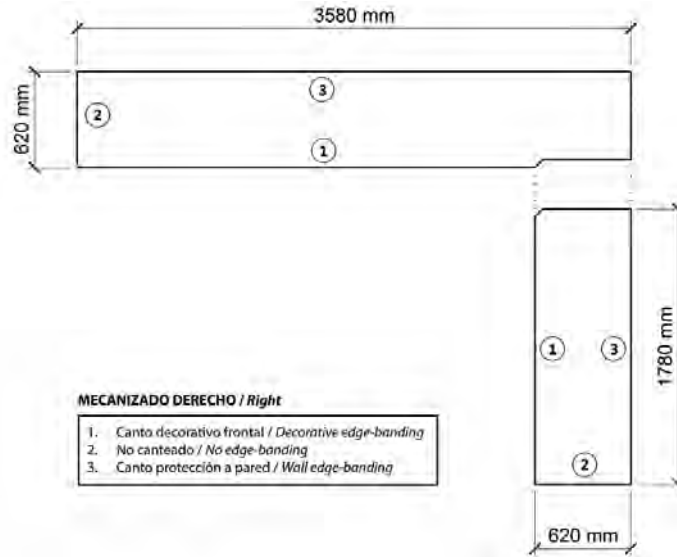

ENCIMERA RECTA MECANIZADO IZQUIERDO / Left machined worktop

■ CARACTERISTICAS TECNICAS:

Esquema encimeras mecanizadas izquierdo con terminación recto canteado.
 Medidas: 3580x620x380 mm + 1780x620x38 mm.
 Tira de laminado para cantos (3600x45 mm) no incluida.

■ FEATURES:

Left machined worktops diagram with termination straight edged.
 Measurements: 3580x620x380 mm + 1780x620x38 mm.
 Laminate edge strip (3600x45 mm) not included.

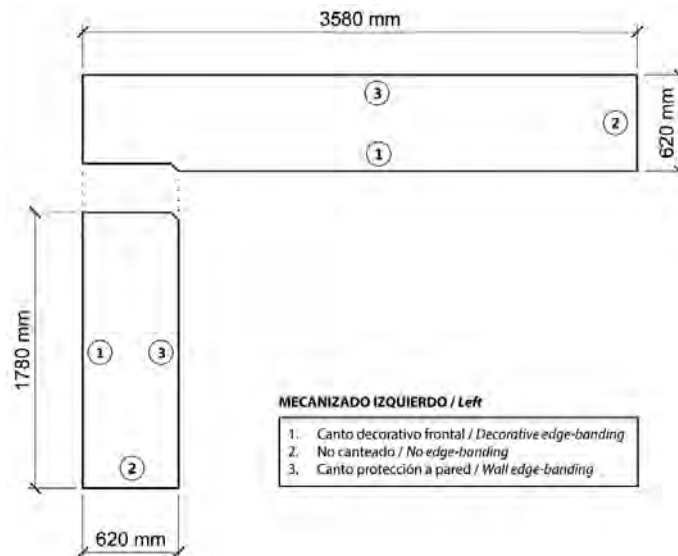



DISEÑOS ENCIMERAS / Worktops designs

	ANNAPURNA GRIS ANC-042 ANNAPURNA			
	REFERENCIA Reference	MECANIZADO DERECHO Right machined	MECANIZADO IZQUIERDO Left machined	TIRA LAMINADO Laminate strip
	ENCIMERA 3580X620 Worktop 3580x620	0300321	0300310	9103321
	ENCIMERA 1780X620 Worktop 1780x620	0300343	0300332	9103321

	ANNAPURNA GRAFITO ANG-044 ANNAPURNA			
	REFERENCIA Reference	MECANIZADO DERECHO Right machined	MECANIZADO IZQUIERDO Left machined	TIRA LAMINADO Laminate strip
	ENCIMERA 3580X620 Worktop 3580x620	0300322	0300311	9103325
	ENCIMERA 1780X620 Worktop 1780x620	0300344	0300333	9103325

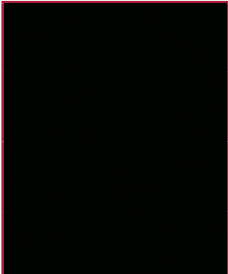
	MARMOL CALACATTA CAL-800 FEEL			
	REFERENCIA Reference	MECANIZADO DERECHO Right machined	MECANIZADO IZQUIERDO Left machined	TIRA LAMINADO Laminate strip
	ENCIMERA 3580X620 Worktop 3580x620	0300326	0300315	9103503
	ENCIMERA 1780X620 Worktop 1780x620	0300348	0300337	9103503

	NEGRO ENCERADO GLP-283 ROCK			
	REFERENCIA Reference	MECANIZADO DERECHO Right machined	MECANIZADO IZQUIERDO Left machined	TIRA LAMINADO Laminate strip
	ENCIMERA 3580X620 Worktop 3580x620	0300324	0300313	9103609
	ENCIMERA 1780X620 Worktop 1780x620	0300346	0300335	9103609

	NEGRO PROFUNDO INN-816 NDF			
	REFERENCIA Reference	MECANIZADO DERECHO Right machined	MECANIZADO IZQUIERDO Left machined	TIRA LAMINADO Laminate strip
	ENCIMERA 3580X620 Worktop 3580x620	0300325	0300314	9103796
	ENCIMERA 1780X620 Worktop 1780x620	0300347	0300336	9103796

	ÓXIDO MARRÓN OXM-444 WAX			
	REFERENCIA Reference	MECANIZADO DERECHO Right machined	MECANIZADO IZQUIERDO Left machined	TIRA LAMINADO Laminate strip
	ENCIMERA 3580X620 Worktop 3580x620	0300327	0300316	9102196
	ENCIMERA 1780X620 Worktop 1780x620	0300349	0300338	9102196

DISEÑOS ENCIMERAS / Worktops designs

	ROBLE NATURAL RON-803 OPEN PORE			
	REFERENCIA <i>Reference</i>	MECANIZADO DERECHO <i>Right machined</i>	MECANIZADO IZQUIERDO <i>Left machined</i>	TIRA LAMINADO <i>Laminate strip</i>
	ENCIMERA 3580X620 <i>Worktop 3580x620</i>	0300320	0300309	9103540
ENCIMERA 1780X620 <i>Worktop 1780x620</i>	0300342	0300331	9103540	

	ROBLE TOSTADO ROS-804 OPEN PORE			
	REFERENCIA <i>Reference</i>	MECANIZADO DERECHO <i>Right machined</i>	MECANIZADO IZQUIERDO <i>Left machined</i>	TIRA LAMINADO <i>Laminate strip</i>
	ENCIMERA 3580X620 <i>Worktop 3580x620</i>	0300319	0300308	9103541
ENCIMERA 1780X620 <i>Worktop 1780x620</i>	0300341	0300330	9103541	

	PIZARRA NEGRA SLN-440 ROCK			
	REFERENCIA <i>Reference</i>	MECANIZADO DERECHO <i>Right machined</i>	MECANIZADO IZQUIERDO <i>Left machined</i>	TIRA LAMINADO <i>Laminate strip</i>
	ENCIMERA 3580X620 <i>Worktop 3580x620</i>	0300323	0300312	9103550
ENCIMERA 1780X620 <i>Worktop 1780x620</i>	0300345	0300334	9103550	

D.

custom 



TOP FORM

PERSONALIZA TU ZONA DE TRABAJO / Customize your working zone



TE GUIAMOS EN TODO MOMENTO / We guide you at all times _____

■ En las siguientes páginas podrás obtener una guía de ayuda para poder elegir tu encimera, aquella que te representa y con la que ganarás funcionalidad y diseño. Son decisiones que hay que tomar con mucha calma, pero ese tiempo que emplees ahora te dará una garantía durante muchos años.

De forma fácil y sencilla podrás configurar tu encimera a medida, obteniendo información sobre los productos, los diseños y todos los complementos y accesorios que puedan incorporarse.

Si te parece complejo cómo tomar las medidas, no te preocupes, te ayudaremos a solucionar tus dudas para que no tengas ningún problema.

■ *The next pages will guide you to choose the worktop you need with the highest functionality and design. The time you spend now in choosing the best option will definitely increase its quality for a lot years.*

By following this guide you will be able to configure your made-to-measure worktop easily, and you will get all the necessary information about the products, designs, complements and accessories.

If you think that measuring could be hard, don't worry, we would be glad to answer to any question you might have.



CONTENIDO DE MI KIT DE ENCIMERA / The content of my worktop set _____

■ Recibirás todo lo que necesite tu encimera. No te preocupes por nada, tu pedido se entregará con todo lo necesario para instalarla de forma autónoma siguiendo los pasos que te indicamos..

■ *You will receive everything you need to set the install the worktop, just follow our advice.*

ENCIMERAS LAMINADAS / Laminate worktop

■ Están compuestas por un tablero aglomerado de partículas con tratamiento hidrófugo, recubierto de un laminado decorativo HPL de 0,7 mm de espesor con film protector y con gran calidad y diseño. Su precio competitivo junto a su peso ligero y a su máxima resistencia hacen que esta encimera una muy buena opción para tu zona de trabajo. Los laminados son materiales de larga duración y que dan la posibilidad de combinar por su gran variedad con el resto de la cocina. Estas además se pueden convertir en mostrador si en tu cocinas tienes una isla central.

■ *Laminate worktops are manufactured on moisture resistant particle board base covered by a decorative HPL laminate and a protective film. Competitive prices, low weight and high resistance make these worktops a good choice for your work area. The laminates are long lasting materials with many decorative options to mix in your kitchen. These can also be converted into a bartop if you have a central island in your kitchen.*

ENCIMERA Y MOSTRADOR POSTFORMADO RADIO 3 mm

Postformed radius 3 mm worktop and bartop

Terminación: postformado con radio 3 mm perfilado.

Espesor: 38 mm. Profundidad 620 mm.

Soporte: Hidrófugo. Dorsal: acabado SUPRA.

Finish: 3 mm radius postformed with profiling.

Thickness: 38 mm. Depth 620 mm.

Core: Moisture resistant. Back: SUPRA finish.

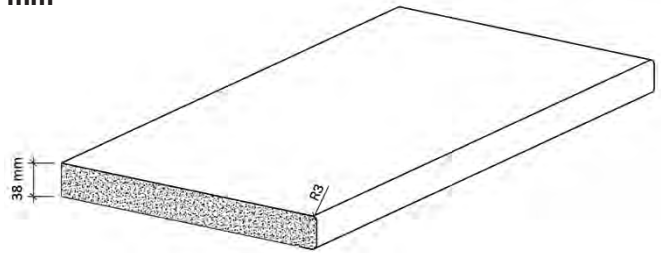

EL DISEÑO QUE MEJOR SE ADAPTA A TUS NECESIDADES

The design that suits you best

■ Elegir el color de tu encimera va a ser un factor fundamental para hacernos sentir que la cocina es uno de nuestros lugares preferidos. Dentro de nuestra amplia gama seguro que hay algún diseño que te enamora y que te hace sentir como en una nube.

■ *The selection of the colour of your worktop will be an important decision. Take your time to choose within our broad range the perfect finish and design for your kitchen.*

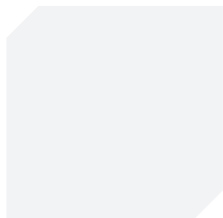

REFERENCIA ►

Reference

SELLADOR / Colorfill



Blanco Islandia
3091 SEF
9904167

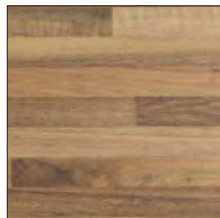

Tablillas
CAT-178 SOFT
9904199

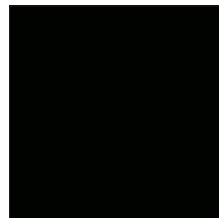

Negro encerado
GLP-283 ROCK
9904188



Blanco Groenlandia
INB-812 NDF
9904167



Negro profundo
INN-816 NDF
9904188

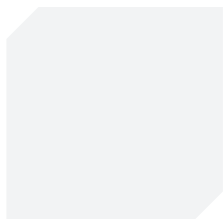

REFERENCIA ►

Reference

SELLADOR / Colorfill

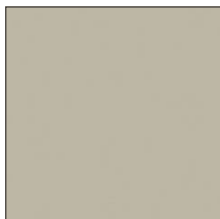

Café mokachino
INP-813 NDF
9904185

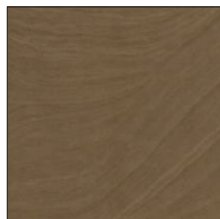

Arena duna
KMM-740 WAX
9904192

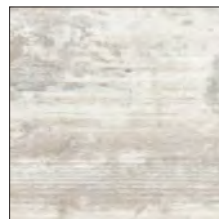

Pino Talco
LAR-770 SOFT
9904193



Azul metálico
MTA-768 BRILLO
9904194

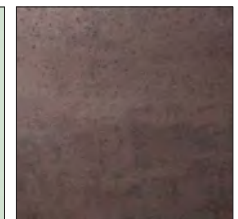

Óxido azulado
OXA-445 WAX
9904197

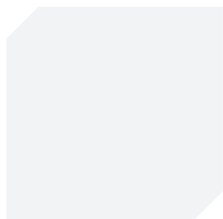

REFERENCIA ►

Reference

SELLADOR / Colorfill



Óxido marrón
OXM-444 WAX
9904183

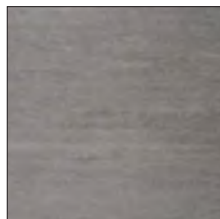

Cemento
TRC-443 WAX
9904202



Cemento claro
VEC-773 WAX
9904203

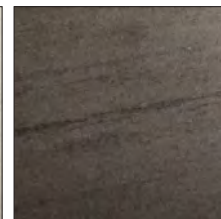

Cemento oscuro
VEO-774 WAX
9904189

COMPLEMENTA TU ENCIMERA / Worktop accesories

■ Algo que cada vez está siendo más típico en las cocina son los paneles verticales o SplashBack entre la encimera y los muebles altos. También es posible que complementes tu encimera con un Copete capaz de dar el toque de detalles que necesitas. La altura del copete siempre es de 200 mm. Estos productos son del mismo material de tu encimera laminada.

■ *Splashback are getting more and more popular. These panels are placed between the worktop and the wall units to protect the wall our 200 mm worktop upstands will give a clean and integrated touch to your worktop. Splashback will be perfectly integrated.*

CARACTERISTICAS TECNICAS:

- Canteado por sus 4 lados con PVC.
- Corte y canteo incluido en el precio.
- Siempre que se exceda de las dimensiones máximas marcadas para para ambos productos y materiales, se tendrá que considerar como 2 piezas independientes.

Features

- 4 sides PVC
- Cutting and edging included in the price.
- If the required size is bigger than our largest measure they will be considered as 2 independent pieces.

VENTAJAS:

- Protege la superficie
- Unifican el plano horizontal con el vertical a través del mismo material.
- Mismas bondades que las encimeras de laminado.

Advantages:

- Protects the wall surface.
- They unify the horizontal plane to the vertical using the same material.
- Same advantages than laminate worktops.



DESCRIPCIÓN Description	GROSOR Thickness	ALTURA MINIMA Minimum height	ALTURA MÁXIMA Maximum height	LARGO MINIMO Minimum length	LARGO MÁXIMO Maximum length
Splashbacks laminado Laminate splashback	19 mm	—	1350 mm	—	3550 mm
Copete laminado Worktop ending	19 mm	200 mm	200 mm	1000 mm	3550 mm

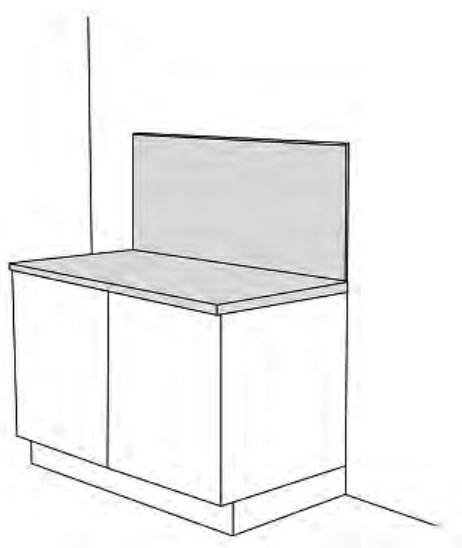

Splashbacks laminado
Laminate splashback

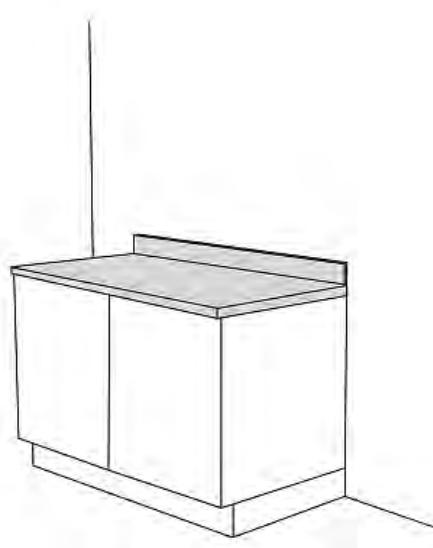

Copete laminado
Worktop ending

RECOMENDACIONES PARA LA INSTALACION DE SPLASHBACK

Splashbacks installation recommendations

- A continuación se explican las fórmulas más eficientes de instalación y montaje de los splashback. Estas directrices pretenden ayudarte a lograr los mejores resultados posibles.
- *The following explains the most efficient way to install and assembly the splashbacks.*

PREPARACIÓN:

- Antes de montarlo asegúrese de que la pared está seca, sin humedades, y plana; compruebe previamente su plenitud con un nivel. Dado que las paredes pueden presentar falta de plenitud, con crestas o valles, se aconseja tratar de enrasarlas previamente, una cinta adhesiva de doble cara, de espuma o fieltro, puede solventar irregularidades de 2-4 mm y ayudarle en esta tarea.

Si las paredes están excesivamente desniveladas o presentan humedades, deben cubrirse con una membrana de caucho EPDM y fijar previamente sobre ellas listones verticales a modo de rastreles dejando una distancia máxima entre ellos de 400 mm.

Preparation:

- *Before fitting the splashback make sure that the wall is completely dry and smooth. We recomend you to check the wall with a spirit level. A double-sided foam or felt tape, can solve irregularities of 2-4 mm. If the walls are uneven or wet the walls should be covered with an EPDM rubber excessive moisture, they should be covered with a rubber membrane EPDM presetting and vertical alats on them as a batten leaving a maximum distance between them of 400 mm.*

CORTE:

- Con el tablero bien apoyado, marque la posición del corte en la cara posterior y con un sargento fije una regla en la posición adecuada. Recuerde dejar espacio para la máquina cortadora cuando coloque la regla. Y, usando la regla como guía, coloque la sierra contra ella y corte el tablero. Una vez cortado, el borde del splashback se puede suavizar usando una fresadora y una regla.

Si usa una fresadora, por favor, asegúrese de dejar margen para el corte cuando tome las medidas.

Cutting:

- *With the board well supported, draw a line of the cut on the back and a sergeant set a rule in the appropriate position. Remember to leave space for the cutting machine when placing the order. And, using the ruler as a guide, place the saw against it and cut the board. Once cut, the edge of the splashback can be smoothed using a milling machine and a ruler. If you use a milling machine, please remember to leave room for cutting when taking the measurements.*

NOTAS:

- Tenga un mayor cuidado cuando use laminados de superficie brillante. Aunque las encimeras vienen suministradas con un film de protección, cuando se trata de diseños/colores de superficie brillante se recomienda a la hora de cortarlos, cubrir la superficie con un tablero para protegerla de los posibles arañazos de la máquina de pequeñas virutas o suciedad y producirse a arañazos que rompan el film protector y terminen por afectar al laminado.

Notes:

- *Be especially careful when using glossy laminate surfaces. Even if the worktops are supplied with a film, when it comes to glossy surfaces, it is recommended to cover the surface with a board when cutting.*

RECORTES O HUECOS INTERNOS:

- Cuando haga un recorte en el splashback, asegúrese siempre de que las esquinas internas sean redondeadas esto prevendrá la aparición de fisuras por tensión. Para obtener este acabado use, o bien una fresadora manual (con sierra), o bien con un taladro y sierra caladora. Marque la zona de corte en la posición correcta de la cara vista y taladre un agujero en cada una de las cuatro esquina, de entonces la vuelta al tablero y marque una línea recta entre los agujeros. Con la ayuda de una sierra caladora de hoja bien afilada y cortando hacia arriba, corte a lo largo de las líneas asegurándose de no cortar más allá de las esquinas redondeadas.

Todos los bordes deben suavizarse con una lima o una lija para evitar el astillado, nuevamente proteja la superficie brillante de los arañazos usando un tablero protector.

Cuts or internal holes:

- *When making a cut in the splashback, make sure that the inner corners are round, this will prevent the appearance of stress cracks. In order to achive a round finish, use a manual milling machine (with a saw) or a drill and jigsaw. Mark the cutting area in the laminate side of the worktop and drill holes in the four corners. Afterwards, flip the worktop and mark a straight line between the holes. Using a jigeaw, cut along the line. All edges should be smoothed with a file or sandpaper to avoid splintering. Again protect the shiny surface of the scratches using a protective board.*

PAREDES DE AZULEJOS, MÁRMOL O METÁLICA:

- Se entiende que la pared estará suficientemente plana y sin resaltes. Para favorecer la adherencia del adhesivo que se aplicara posteriormente, se deberá desengrasar previamente la pared con alcohol.

Cement walls:

- *Once the the wall is sufficiently flat and without projections. In order to improve the adhesion of the glue, the wall should be degreased with alcohol.*

PAREDES DE CEMENTO:

■ Se recomienda aplicar previamente una pasta auto-niveladora o lechada de cemento, que enrase y aplane dicha pared para evitar los vanos, crestas y resaltes de la misma.

Cement walls:

■ It is recommended to apply a self-leveling cement paste or cement ground to flatten the wall and to avoid hollows and projections.

IMPRIMACIÓN PARA PEGADO:

■ En el caso de pegar el splashback sobre azulejo o sobre una superficie metálica, se recomienda también dar previamente una imprimación a la pared, para garantizar la adherencia posterior del laminado. Esta imprimación será la recomendada en cada caso por el fabricante del adhesivo y se aplicará y dejará secar con arreglo a las instrucciones del fabricante del mismo.

Primer:

■ *In the case of gluing the splashback in tiles or metal surfaces, it is also recommended to give a primer to the wall to ensure the adherence of the laminate. This kind of primer should be recommended for the glue manufacturer.*

MONTAJE DEL SPLASHBACK:

■ Una vez cortado a la medida el splashback se puede montar éste usando adhesivos específicos para pared o tablero "SIKA TACK PANEL". Cuando use un panel adhesivo de pared, por favor, siga las instrucciones del fabricante de la cola que aparecen en el tubo. Independientemente del método de fijación utilizado, se recomienda colocar, tanto la cinta adhesiva como el cordón de cola, a una distancia que no supere los 150 mm entre el siguiente eje de aplicación. Si la pared de apoyo no está totalmente seca, se debe entonces usar una subestructura de madera y el splashback o frente de cocción ha de pegarse sobre ella, permitiendo que el aire circule detrás del tablero. En todos los casos, entre el splashback y la encimera debe siempre dejarse forzosamente una distancia libre de al menos 3 mm. Ese hueco puede rellenarse con un sellador de silicona a juego con el color del tablero. Cuando se trabaja en una esquina interior, nuevamente, es recomendable dejar un pequeño hueco de aproximadamente de 3 mm que pueda ser rellenado con un sellador de silicona que combine con el laminado. Esto permitirá los movimientos de dilatación y contracción debidos a los cambios climáticos. Por favor, tenga muy presente que el splashback no puede pegarse directamente sobre yeso.

Splashback mounting:

■ *Once the splashback has been cut to measure, it can be mounted using specific adhesives for walls or panels like "SIKA TACK PANEL". It is recommended to place a tape at a distance not exceeding 150 mm between the following application axis. If the wall is not dry, a wooden substructure should be placed and then the splashback should be glued on it letting the air circulate behind the backboard. In all cases, between the splashback and the worktop should necessarily leave a gap of 3 mm. That gap can be filled with silicone sealant with a matching colour. When working in a corner, leave a small gap of 3 mm that can be filled with a silicone sealant that combines with the laminate. This will allow expansion movements and contraction due to climate change. Please keep in mind that the splashback can not be pasted glue on gypsum.*

MONTAJE JUNTO A LOS FUEGOS DE LA COCINA:

■ Los splashback pueden instalarse adyacentes a los fuegos de la cocina. Si se trabaja junto a un fuego de gas, se recomienda dejar una distancia mínima de 50 mm desde el borde del fuego hasta la superficie del splashback.

Installation next to the cooking fires:

■ *The splashback can be installed by the cooking appliances. If working with a gas stove it is recommended a minimum distance of 50 mm from the edge of the stove to the surface of the splashback.*

OTROS COMPLEMENTOS QUE TAMBIEN TE VA A SER UTILES:

■ Para tener una terminación completa de tu Copete o Splashback laminado, el copete de unión para panelar la pared sobre la encimera es la solución ideal. Largo máximo de la tira: 3000 mm. Acabado en acero cepillado. Además otros complementos también para este tipo de producto son las terminaciones y prolongaciones para el copete tanto para la como para la izquierda. Cada encimera irá asociada a un **color para el sellado de las uniones**. En la tabla de diseños encontraras el nº de referencia de cada uno.

Other useful accessories:

■ *In order to have a finished splashback, the joint worktop upstand is the ideal solution. Maximum length of the strip: 3000 mm. Brushed stainless steel finish. Beside other complements also for this type of product are the end cap and the adapter moulding for the edging of attachment for wall panelling (right and left sides). Each worktop will be associated with a **color for sealing the joints**. In the table of designs you will find the reference number of each one.*

DESCRIPCIÓN / Description	CODIGO / Code
Copete unión panel laminado / Laminate worktop joint upstand	9904465
Tapa lateral izquierda / Left end cap	9904466
Tapa lateral derecha / Right end cap	9904467
Prolongación copete izquierda / Left adapter moulding	9904469
Prolongación copete derecha / Right adapter moulding	9904468

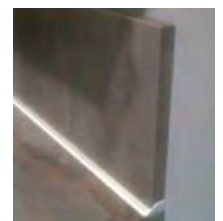

LAS MEDIDAS QUE TE HARÁN SOÑAR / Measures that will make you dream _____

■ Después de haber elegido el diseño de tu encimera, ahora tu eres la parte más importante. Toma las medidas para personalizar el producto como le necesites. No te preocupes por nada, te ayudaremos informándote cómo coger esas medidas.

■ *After choosing the design of your worktop customize it!. Please take note of our measuring tips.*

DISTRIBUCIONES TÍPICAS:

■ Te ofrecemos unos dibujos estándar sobre las distribuciones más típicas del mercado. No va a ser exacta a la tuya, pero te ayudara a orientarte a la hora de representarla.

Regular layout:

■ *We propose several standard drawings with the most common designs..*

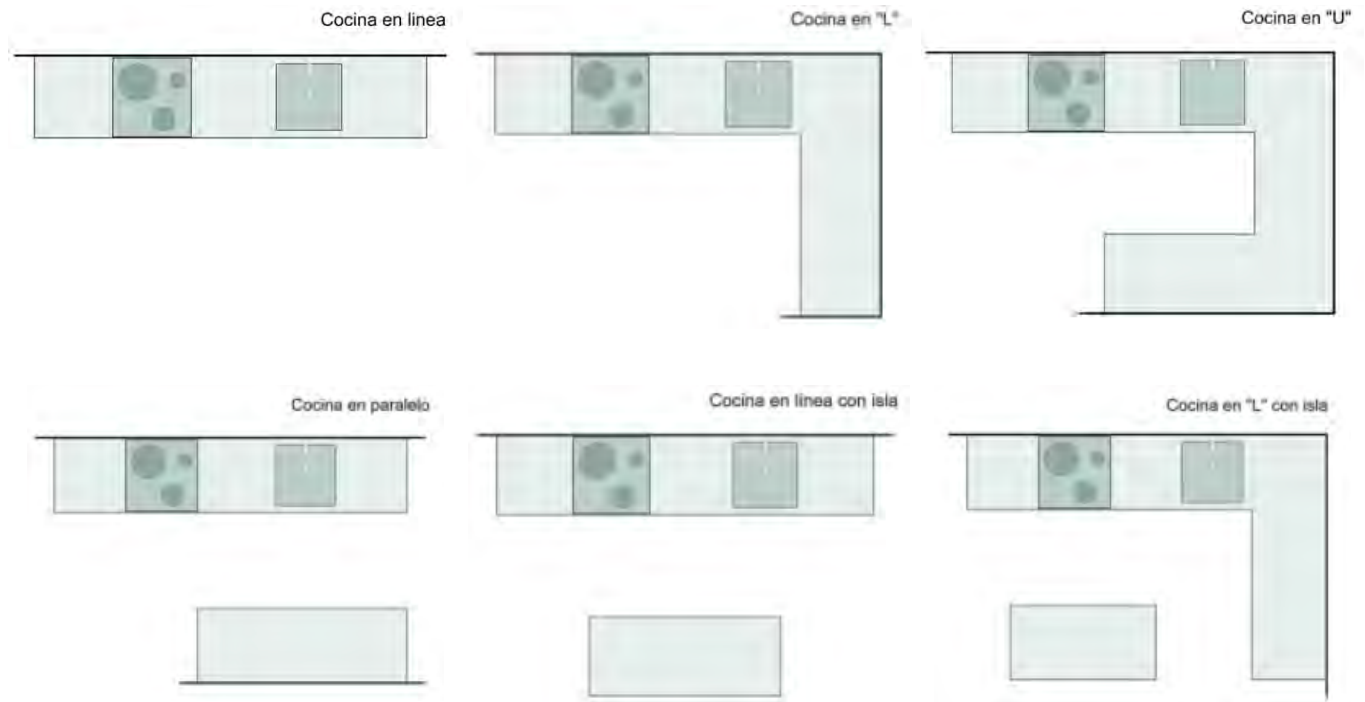

DIBUJA TU COCINA / Draw your kitchen _____

■ La mejor forma de enseñarnos cómo necesitas tu encimera es dibujándola, en el espacio reservado para ello. Después mide el largo desde un vértice hasta el otro, así en todas las partes que tenga la distribución de tu encimera, de la misma manera tomamos la medida del fondo.

■ *The best way to show us the worktop you need is by drawing it in the form. Then measure the lengths and depth of the kitchen.*

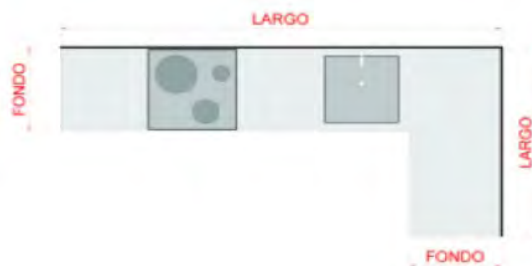

OBSTÁCULOS EN PAREDES / Obstacles in the walls

■ Cuando nos encontramos con una columna o con cualquier obstáculo en el camino, puede dificultar la toma de medidas, pero nada es imposible. La solución es medir desde el vértice más cercano hasta donde se encuentre la columna u obstáculo donde tengamos que realizar el cajeadado. Así mediremos la distancia entre ambos (punto A y B). Indicaremos la medida de sus lados con la distancia entre el punto B y C y entre C y D, según se puede ver en la representación.

■ *Finding a column or any other obstacle in the way, could complicate measurement. The solution is to measure from the closest vertex to place where the column or obstacle is located. We measure the distance between point A to B, B to C and C to D.*

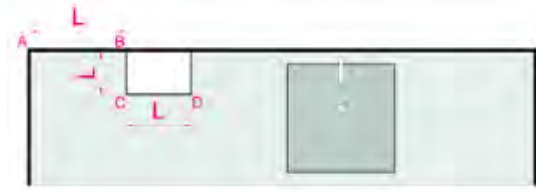

■ Puede que tengas algún obstáculo con una forma irregular, para ello deberás de intentar darnos el mayor número de datos, según se puede ver en la representación.

■ *If the obstacle has an irregular shape, give us information as possible.*

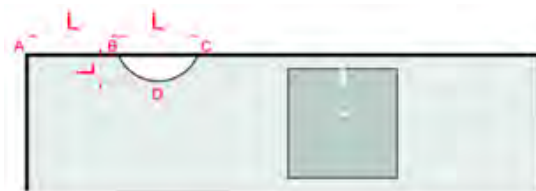

■ Cuando el cajeadado esté situado en una esquina, tomamos las medidas de sus lados tal y como vemos en el ejemplo con los puntos A y B; A y C.

■ *When the hole is located in a corner, taking the measurements of its sides as we see in the example with the points A and B; A and C.*



■ Para aquellos cajeadados con forma irregular, de igual manera intentaremos dar el mayor número de datos posibles.

■ *Once again if the obstacle has an irregular shape, give us information as possible.*



■ Para presupuestar estos trabajos se cotiza como un cajeadado.

■ *Ask us about how to quote these modifications.*

ESQUINAS EN CHAFLAN / Chamfers

■ Puede que tu encimera tenga una esquina "chaflán" que elimine el ángulo de 90° que se forma. Toma bien las medidas de tu esquina desde el vértice más cercano como tienes en la imagen.

Para presupuestar estos trabajos se cotiza como un cajeadado.

■ *Your worktop might have a "chamfer" measure from the closet as in the picture. Ask us about how to quote these modifications.*

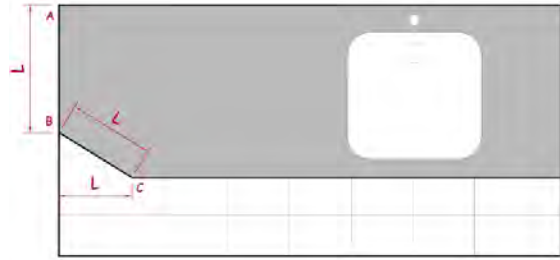

VARIEDADES DE ÁNGULOS / Diversities in angles

■ Puede que tu encimera tenga una esquina "chaflán" que elimine el ángulo de 90° que se forma. Toma bien las medidas de tu esquina desde el vértice más cercano como tienes en la imagen.

Para presupuestar estos trabajos se cotiza como un cajeadado.

■ *If the wall is not completely straight, the angle between the wall and the worktop won't have 90°*

In order to check the 90° angle, measure the diagonals of your room, if these coincide, your corners have a 90° angle.

■ También puedes comprobarlo de la siguiente manera: Si mides en uno de los lados de la esquina 60 cm y en el otro 80 cm, y la diagonal que se forma entre éstas es 100 cm, hay un ángulo de 90° .

■ *Another way for to check is the following: If you measure 60 cm in one side of corner and in the other 80 cm, the diagonal between both of them must be 100 cm, in a 90° angle.*

■ Si resulta que esto no coincide, danos las medidas de tu habitación (de todos los lados) así como las diagonales de las mismas.

■ *If you find that the angle between the walls is not 90° , give us the measures of your room (all sides) as in the diagonals of the same.*

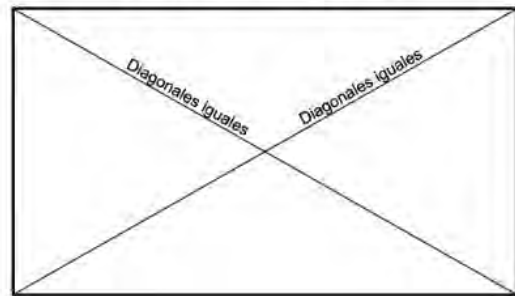
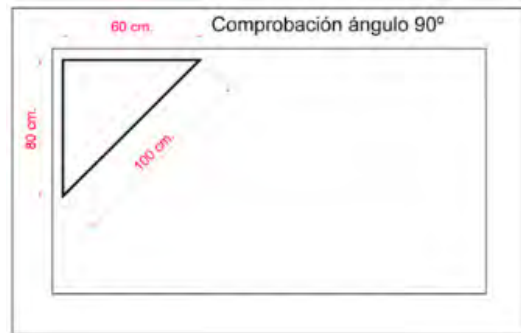
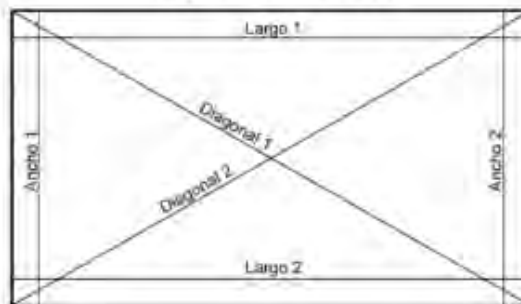
Comprobación ángulo 90° Comprobación ángulo 90° Ángulo diferente de 90° 

LA ISLA DE TU COCINA / Kitchen island

■ Puede que tu encimera tenga una esquina “chablán” que elimine el ángulo de 90° que se forma. Toma bien las medidas de tu esquina desde el vértice más cercano como tienes en la imagen.

Para presupuestar estos trabajos se cotiza como un cajeadado.

■ *Your worktop might have a “chamfer” measure from the closet as in the picture. Ask us about how to quote these modifications.*



UNA “T” POR COCINA / T shaped kitchens

■ Existen muchos tipos de distribución de cocina como hemos visto antes, una muy peculiar y a la que queremos hacer hincapié es en la cocina en “T”.

Normalmente con la encimera en este tipo de cocinas, hay una parte sobresaliente pero que tiene una forma de medida al igual que el resto. Tomamos las distancias de sus vértices hasta la parte sobresaliente y así con el resto de sus lados.

■ *There are many types of kitchen layouts as we have seen before. We would like to highlight the “T” shaped kitchen. Normally, the worktop for “T” shaped kitchens sticks out so we would have to measure the distances between its vertices.*

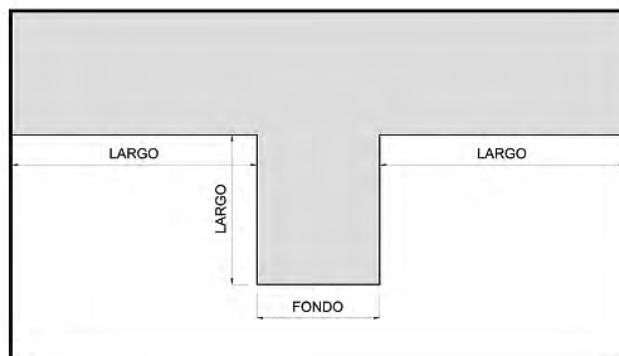

ENTRADAS IMPORTANTES / Worktop drilling

■ Dada la diversidad tanto de fregaderos, placas y otros complementos de encimera que necesitan perforarla, debes de enviarnos los datos técnicos con los planos de cada uno de ellos, que lo podrás encontrar en el packaging de tu proveedor. Sobre todo sería fundamental los datos del diagrama de encastre. De esa manera eliminaremos los posibles errores.

■ *As there are so many kinds of appliances and accessories that require drilling in the worktop, we need all the technical information. Information from the supplier in order to customize your worktop. The most important information we require in order to avoid any problem is the fitting plan.*

■ Para indicar las dimensiones, medimos los lados del encastre si tiene forma cuadrada o rectangular y el diámetro, si tiene forma circular.

Al tener forma rectangular o cuadrada es muy difícil que sea tan exacto, lo normal es que tenga un pequeño radio en las esquinas. Para ello habría que indicar el radio de empalme de los lados (R).

Nota: El radio de curvatura que tendrá el encastre en las esquinas va a ser de 8 mm por defecto (indicar radio de empalme propio)..

■ *In order to indicate the drill measurements, measure the different sides of the squared holes or the diameter of the circle shaped ones. The radius between the different sides of the hole might be different.*

Note: *We will consider an 8mm radius if no other information is given.*

■ También tenemos que indicar la posición de nuestras placa o fregadero. Para ello debemos de tomar el eje central (eje de coordenadas) desde el vértice más cercano.

Nota: Las perforaciones para el grifo son una entrada más, las cuales hay que señalar posición y dimensiones. A la hora de presupuestar, el trabajo utilizado es el de "encastre"..

■ *We also have to indicate the position of our hob or sink. We must take the central axis (as shown in the drawing) from the closest vertex.*

Note: *The holes for the taps must be also indicated.*



Mueble	600 mm
Válvula	3 1/2"
Orificio de grifería	1
Dimensiones	600 mmx500 mm
Cubeta/s	530 mmx390 mmx170 mm
Número de cubetas	1
Encastre	580 mmx480 mmxR: 20 mm
Acabado	Acero Inoxidable Pulido

Dimensiones del encastre

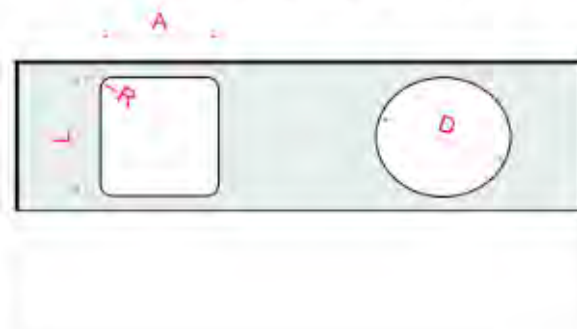

Eje del encastre



DETALLES QUE FUNCIONAN / *Finish ideas*

- Puedes crear increíbles contrastes al elegir el tipo de canteado que necesitas para cada lado de cada zona de tu encimera.
- You can create amazing contrasts when choosing the different edging options.

LOS TIPOS DE CANTEADO QUE TE OFRECEMOS SON:

Types of edging:



"P" Canteado con postformado.
Postformed edging.



"D" Canteado a pared.
Edging to wall.



"L" Canteado en laminado.
Laminate edging.



"V" Canteado PVC.
PVC edging.



- **"P"** Canteado con postformado: Es un tipo de canteado que se realiza en los lados cortos de la encimera (testas) o de los mostradores para suprimir el canto recto y generar una imagen homogénea principalmente cuando en el largo frontal principal, el canteado es postformado por el tipo de modelo elegido..

■ **"P"** Edging with postforming: it's a kind of edging that is lipped on the short sides of the worktop (heads) or bartops that eliminates the straight edge generating a homogeneous image especially for long main fronts, chamfering is postformed by the type of model chosen.

- El lateral de la encimera que vaya directamente a pared llevará consigo un trabajo de corte, perfilado y canteado a pared.

En el largo principal (frontal) de la encimera la terminación de canteado que va a traer consigo va a ser el propio perfil, aquí no habrá que señala tipo de canteado. Señala en un cuadro el tipo de canteado que necesitas en cada uno de los lados de cada zona, utilizando las siglas designadas al respecto.

- *The side of the worktop that goes directly to the wall will carry with its job of cutting, profiling and edging to the wall.*

On the main (front) length of the countertop, the edging finish that it will bring with it will be the profile itself, here there will be no type of edge. Mark in a box the type of edging you need in each one of the sides of each zone, using the designated abbreviations..

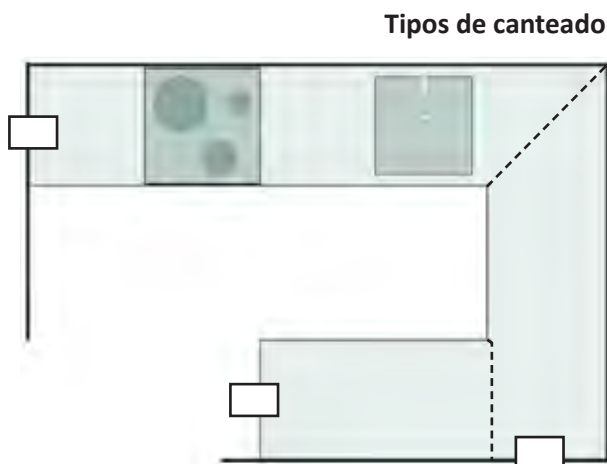

DESCRIPCIÓN / <i>Description</i>	ABREVIATURA / <i>Abbreviation</i>	RESTRICCIONES / <i>Restrictions</i>
Postformado / <i>Postforming</i>	P	No cortes en chaflán / <i>Not cut chamfer corner</i>
Pared / <i>To wall</i>	D	Disponibe / <i>Available</i>
Laminado / <i>Laminated</i>	L	Disponibe / <i>Available</i>
PVC / <i>PVC</i>	V	No cortes en chaflán / <i>Not cut chamfer corner</i>

DISTRIBUYE TU ENCIMERA / Worktop layout

- Quién mejor que tú para decidir qué tipo de unión quieres en tu encimera. También decidir en qué partes dividirla cuando la encimera tenga más de 3580 mm y cuando haya distintas uniones. Te ofrecemos la posibilidad de que seas el diseñador de tu cocina, sintiéndote el mayor protagonista.
- *It is to you to decide what type of joint you want for your worktop and how to break-down worktops longer than 3580.*

TIPOS DE UNIONES / Joints

(U1) INGLETE A 45°

■ Unión para esquinas con ángulos de 90° donde se divide el ángulo en partes iguales para cada lado de la encimera resultante.

(U1) Mitre 45°

■ *Joint for corners with 90° angles as in the drawing.*

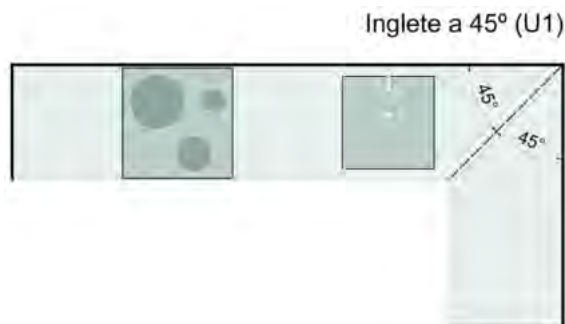
**(U2) INGLETE DISTINTO A 45°**

■ Es posible que su pared no esté totalmente recta y que el ángulo que se genere en la esquina no sea de 90°. Para ello hay que ver el ángulo que se forma (como se ha visto anteriormente). La unión se realizará dividiendo el ángulo en partes iguales para cada lado resultante de la encimera.

(U2) Mitres different from 45°

■ *For not straight walls the angle is different from 90°. Once we know the joint angle, we divide it by two.*

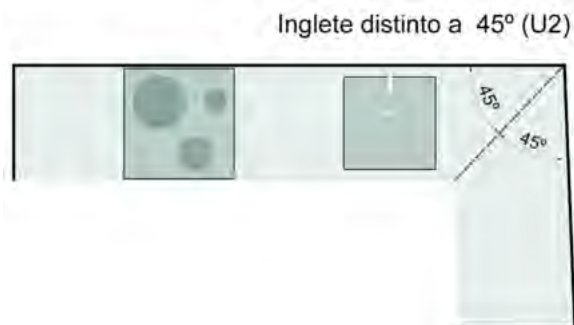
**(U3) PERPENDICULAR**

■ En este tipo de unión una de las partes resultantes de la encimera se introduce en la otra creando un ángulo de 90° grados entre las dos encimeras.

(U3) Perpendicular

■ *In this type of join, one part is put into the other part producing a 90° angle followed by a straight joint.*

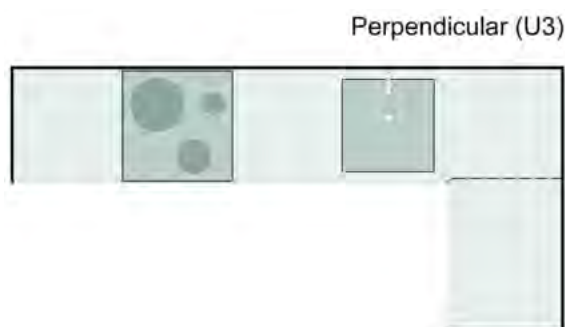
**(U4) PROLONGACIÓN**

■ Se crea una unión contigua entre dos partes (unión en línea recta). Este tipo de unión se utilizará para una prolongación de encimeras cuando necesites un lado mayor a 3580 mm.

(U4) Continuation

■ *Whereas you need a side worktop higher than 3580 the worktops it will be joint as in the drawing.*

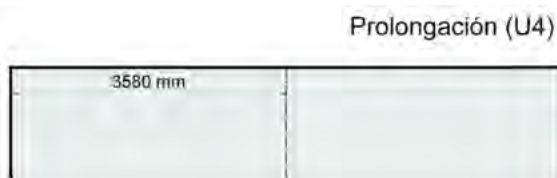

DISTRIBUCIONES ENCIMERAS / Worktops parts

■ Al haber una unión en nuestra encimera se ha generado distintas partes. Estas partes las tenemos que diferenciar.

Para poder entender mejor esto ponemos un ejemplo. Tenemos una encimera en "U" donde hay que decidir el tipo de unión que queremos en cada parte de la encimera. Señalamos donde vaya una unión con una línea poniendo U1, U2... que identifica el tipo de unión. Después nombraremos cada parte resultante con una letra A, B, C. ...

■ *By having a union in our worktop, different parts. These parts we have to differentiate. To better understand this we give an example. We have a "U" worktop where you have to decide the type of joint that we want in every part of the worktop.*

We mark where a union goes with a line by putting U1, U2 ... which identifies the type of join.

Then we will name each resulting part with a letter A, B, C. ...

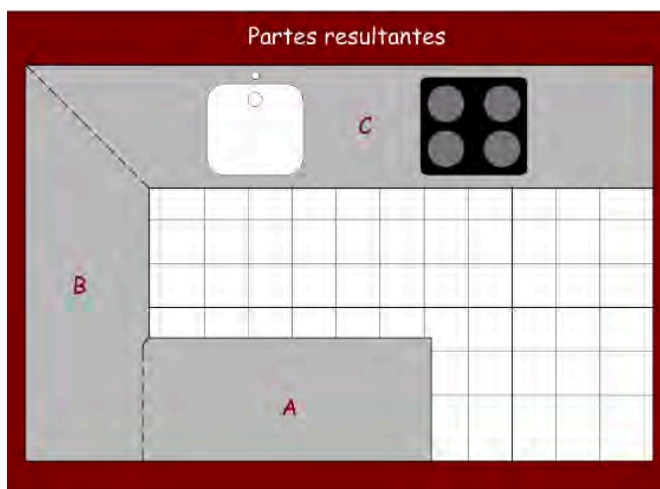
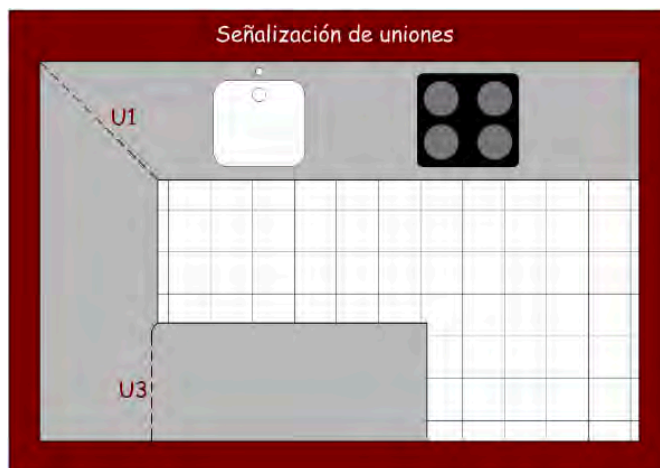



3.

PUERTAS, COSTADOS Y REGLETAS

Doors, cover panels and fillers



TOP FORM

A.



TOP FORM

MODELO ELBA 19 mm

Elba 19 mm model

■ CARACTERÍSTICAS TÉCNICAS:

Terminación: cuatro cantos en ABS de igual color del frente.

Soporte: tablero aglomerado.

Recubrimiento: melamina decorativa acabada en mate y film protector.

Diseños en madera con veta vertical.

Contracara: similar acabado soft.

Adhesivo: resina melaminica.

Espesor: 19 mm.

■ FEATURES:*Finish: four edges in ABS of the same front color.**Core: particle board.**Covering: decorative melamine matt finish and protective film.**Wood designs with vertical grain.**Backside: similar colour soft finish.**Adhesive: melamine resin.**Thickness: 19 mm.*

MEDIDAS DE PUERTAS Doors measures		
UNICOLORES <i>Unicolors</i>	ALTURA <i>Height</i>	ANCHO <i>Width</i>
Máximo <i>Maximum</i>	2800 mm	1197 mm
Mínimo <i>Minimum</i>	100 mm	100 mm
VETA / Grain VERTICAL	ALTURA <i>Height</i>	ANCHO <i>Width</i>
Máximo <i>Maximum</i>	2800 mm	1197 mm
Mínimo <i>Minimum</i>	100 mm	100 mm
VETA / Grain HORIZONTAL	ALTURA <i>Height</i>	ANCHO <i>Width</i>
Máximo <i>Maximum</i>	1498 mm	1197 mm
Mínimo <i>Minimum</i>	100 mm	100 mm

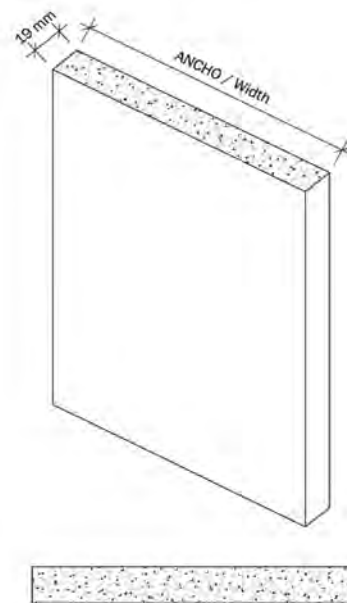

DISEÑOS MODELO ELBA 19 mm

Elba 19 mm model designs

PUERTAS, COSTADOS Y REGLETAS / Doors, cover panels and fillers



**Aguamarina
AGM-834 SEF**



**Arena
ARB-810 SEF**



**Arena claro
ARC-837 SOFT**



**Blanco fresno
BLC-853 PF**



**Blanco polar
BLP-805 SEF**



**Cacao chocolate
CAC-839 SOFT**



**Nogal rústico
CLC-828 SYNCH**



**Nogal alfil
CLN-829 SYNCH**



**Nogal pacífico
CLO-826 SYNCH**



**Nogal natural
ELN-915 VH**



**Nogal negro
ENC-821 SPIRIT**



**Nogal italiano
EXP-823 SPIRIT**

DISEÑOS MODELO ELBA 19 mm

Elba 19 mm model designs



Gris antacita
GAN-811 SEF



Negro
GLP-283 SOFT



Gris claro
GRC-836 SOFT



Roble nudos blanco
HFX-176 RG



Roble nudos natural
HFX-180 RG



Roble nudos tabaco
HFX-181 RG



Roble nudos zinc
HFX-376 RG



Blanco margarita
LEB-851 VETA



Gris margarita
LEG-850 VETA



Roble café
MES-799 V.V



Roble claro
OAC-809 PW



Roble elegance
OAD-822 FUN

DISEÑOS MODELO ELBA 19 mm

Elba 19 mm model designs

PUERTAS, COSTADOS Y REGLETAS / Doors, cover panels and fillers



**Roble avellana
OAM-806 FUN**



**Roble aneto
OAN-807 FUN**



**Roble tostado
OAT-808 PW**



**Olmo tostado
PNH-003 RG**



**Olmo natural
PNH-004 RG**



**Rojo
RED-840 SOFT**



**Roble miel
RHO-027 RG**



**Roble conac
RSC-833 RG**



**Roble azucar
RSO-029 RG**



**Teja
RTE-835 SOFT**



**Roble tropical
SON-798 V.V**



**Nogal tostado
TOS-824 RG**

MODELO ELBA 22 mm

Elba 22 mm model

■ CARACTERÍSTICAS TÉCNICAS:

Terminación: cuatro cantos en ABS de igual color del frente.

Soporte: tablero aglomerado.

Recubrimiento: melamina decorativa acabada en mate y film protector.

Diseños en madera con veta vertical.

Contracara: similar acabado soft.

Adhesivo: resina melaminica.

Espesor: 22 mm.

■ FEATURES:

Finish: four edges in ABS of the same front color.

Core: particle board.

Covering: decorative melamine matt finish and protective film.

Wood designs with vertical grain.

Backside: similar colour soft finish.

Adhesive: melamine resin.

Thickness: 22 mm.



MEDIDAS DE PUERTAS Doors measures		
UNICOLORES <i>Unicolors</i>	ALTURA <i>Height</i>	ANCHO <i>Width</i>
Máximo <i>Maximum</i>	2800 mm	1197 mm
Mínimo <i>Minimum</i>	100 mm	100 mm
VETA / Grain VERTICAL	ALTURA <i>Height</i>	ANCHO <i>Width</i>
Máximo <i>Maximum</i>	2800 mm	1197 mm
Mínimo <i>Minimum</i>	100 mm	100 mm
VETA / Grain HORIZONTAL	ALTURA <i>Height</i>	ANCHO <i>Width</i>
Máximo <i>Maximum</i>	1498 mm	1197 mm
Mínimo <i>Minimum</i>	100 mm	100 mm

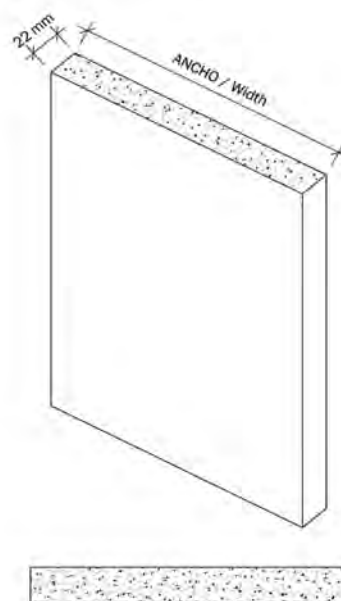

DISEÑOS MODELO ELBA 22 mm

Elba 22 mm model designs

PUERTAS, COSTADOS Y REGLETAS / Doors, cover panels and fillers



**Aguamarina
AGM-834 SEF**



**Arena
ARB-810 SEF**



**Arena claro
ARC-837 SOFT**



**Blanco fresno
BLC-853 PF**



**Blanco polar
BLP-805 SEF**



**Cacao chocolate
CAC-839 SOFT**



**Nogal rústico
CLC-828 SYNCH**



**Nogal alfil
CLN-829 SYNCH**



**Nogal pacífico
CLO-826 SYNCH**



**Nogal negro
ENC-821 SPIRIT**



**Nogal italiano
EXP-823 SPIRIT**



**Gris antacita
GAN-811 SEF**

DISEÑOS MODELO ELBA 22 mm

Elba 22 mm model designs



Negro
GLP-283 SOFT



Gris claro
GRC-836 SOFT



Roble nudos blanco
HFX-176 RG



Roble nudos natural
HFX-180 RG



Roble nudos tabaco
HFX-181 RG



Roble nudos zinc
HFX-376 RG



Roble café
MES-799 V.V



Roble avellana
OAM-806 FUN



Olmo tostado
PNH-003 RG



Olmo natural
PNH-004 RG



Rojo
RED-840 SOFT



Roble miel
RHO-027 RG

DISEÑOS MODELO ELBA 22 mm

Elba 22 mm model designs



**Roble coñac
RSC-833 RG**



**Roble azucar
RSO-029 RG**



**Teja
RTE-835 SOFT**



**Roble tropical
SON-798 V.V**



**Nogal tostado
TOS-824 RG**

MODELO TAMESIS 19 mm

Tamesis 19 mm model

■ CARACTERÍSTICAS TÉCNICAS:

Terminación: canto superior con perfil tirador postformado tipo "J" y cantos rectos en ABS de igual color del frente.

Soporte: tablero aglomerado.

Recubrimiento: melamina decorativa acabada en mate y film protector.

Diseños en madera con veta horizontal.

Contracara: similar acabado soft.

Adhesivo: resina melaminica.

Espesor: 19 mm.

■ FEATURES:

Finish: top edge with postforming profile handle type "J" and straight edges in ABS of the same front color.

Core: particle board.

Covering: decorative melamine matt finish and protective film.

Wood designs with horizontal grain.

Backside: similar colour soft finish.

Adhesive: melamine resin.

Thickness: 19 mm.



MEDIDAS DE PUERTAS Doors measures		
UNICOLORES <i>Unicolors</i>	ALTURA <i>Height</i>	ANCHO <i>Width</i>
Máximo <i>Maximum</i>	1298 mm	2800 mm
Mínimo <i>Minimum</i>	138 mm	100 mm
VETA / Grain HORIZONTAL	ALTURA <i>Height</i>	ANCHO <i>Width</i>
Máximo <i>Maximum</i>	1298 mm	1298 mm
Mínimo <i>Minimum</i>	138 mm	100 mm
VETA / Grain VERTICAL	ALTURA <i>Height</i>	ANCHO <i>Width</i>
Máximo <i>Maximum</i>	1298 mm	1298 mm
Mínimo <i>Minimum</i>	138 mm	100 mm

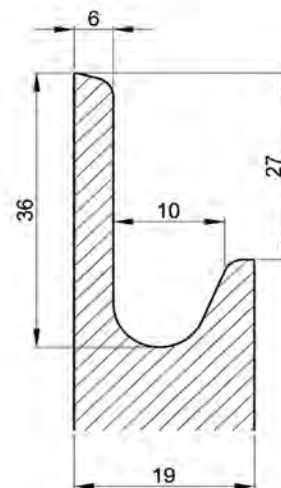

DISEÑOS MODELO TAMESIS 19 mm

Tamesis 19 mm model designs



**Blanco polar
BLP-805 SEF**



**Blanco polar/nogal natural
BLP-805/ELN-915 SEF**



**Nogal natural
ELN-915 VH**



**Roble claro
OAC-809 PW**



**Roble elegance
OAD-822 FUN**



**Roble aneto
OAN-807 FUN**



**Roble tostado
OAT-808 PW**

MODELO TÁMESIS 22 mm

Tamesis 22 mm model

■ CARACTERÍSTICAS TÉCNICAS:

Terminación: canto superior con perfil tirador postformado tipo "J" y cantos rectos en ABS de igual color del frente.
 Soporte: tablero aglomerado.
 Recubrimiento: melamina decorativa acabada en mate y film protector.
 Diseños en madera con veta horizontal.
 Contracara: similar acabado soft.
 Adhesivo: resina melaminica.
 Espesor: 22 mm.

■ FEATURES:

Finish: top edge with postforming profile handle type "J" and straight edges in ABS of the same front color.
 Core: particle board.
 Covering: decorative melamine matt finish and protective film.
 Wood designs with horizontal grain.
 Backside: similar colour soft finish.
 Adhesive: melamine resin.
 Thickness: 22 mm.



MEDIDAS DE PUERTAS Doors measures		
UNICOLORS <i>Unicolors</i>	ALTURA <i>Height</i>	ANCHO <i>Width</i>
Máximo <i>Maximum</i>	1298 mm	2800 mm
Mínimo <i>Minimum</i>	138 mm	100 mm
VETA / Grain HORIZONTAL	ALTURA <i>Height</i>	ANCHO <i>Width</i>
Máximo <i>Maximum</i>	1298 mm	1298 mm
Mínimo <i>Minimum</i>	138 mm	100 mm
VETA / Grain VERTICAL	ALTURA <i>Height</i>	ANCHO <i>Width</i>
Máximo <i>Maximum</i>	1298 mm	1298 mm
Mínimo <i>Minimum</i>	138 mm	100 mm

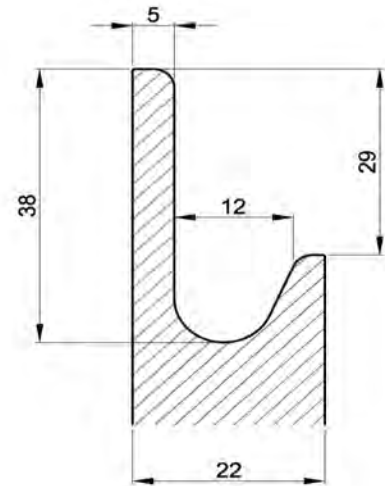

DISEÑOS MODELO TÁMESIS 22 mm

Tamesis 22 mm model designs



Aguamarina
AGM-834 SEF



Arena
ARB-810 SEF



Arena claro
ARC-837 SOFT



Blanco fresno
BLC-853 PF



Blanco polar
BLP-805 SEF



Cacao chocolate
CAC-839 SOFT



Nogal rústico
CLC-828 SYNCH



Nogal alfil
CLN-829 SYNCH



Nogal pacífico
CLO-826 SYNCH



Nogal negro
ENC-821 SPIRIT



Nogal italiano
EXP-823 SPIRIT



Gris antacita
GAN-811 SEF

PUERTAS, COSTADOS Y REGLETAS / Doors, cover panels and fillers

DISEÑOS MODELO TÁMESIS 22 mm*Tamesis 22 mm model designs*

Negro
GLP-283 SOFT



Gris claro
GRC-836 SOFT



Roble nudos blanco
HFX-176 RG



Roble nudos natural
HFX-180 RG



Roble nudos tabaco
HFX-181 RG



Roble nudos zinc
HFX-376 RG



Roble café
MES-799 V.V



Roble avellana
OAM-806 FUN



Olmo tostado
PNH-003 RG



Olmo natural
PNH-004 RG



Rojo
RED-840 SOFT



Roble miel
RHO-027 RG

DISEÑOS MODELO TÁMESIS 22 mm

Tamesis 22 mm model designs



Roble coñac
RSC-833 RG



Roble azucar
RSO-029 RG



Teja
RTE-835 SOFT



Roble tropical
SON-798 V.V



Nogal tostado
TOS-824 RG

MODELO ONEGA 19 mm

Onega 19 mm model

■ CARACTERÍSTICAS TÉCNICAS:

Terminación: canto superior con perfil tirador postformado tipo "U" y cantos rectos en ABS de igual color del frente.
 Soporte: tablero aglomerado.
 Recubrimiento: melamina decorativa acabada en mate y film protector.
 Diseños en madera con veta horizontal.
 Contracara: similar acabado soft.
 Adhesivo: resina melaminica.
 Espesor: 19 mm.

■ FEATURES:

Finish: top edge with postforming profile handle type "U" and straight edges in ABS of the same front color.
 Core: particle board.
 Covering: decorative melamine matt finish and protective film.
 Wood designs with horizontal grain.
 Backside: similar colour soft finish.
 Adhesive: melamine resin.
 Thickness: 19 mm.



MEDIDAS DE PUERTAS Doors measures		
UNICOLORES <i>Unicolors</i>	ALTURA <i>Height</i>	ANCHO <i>Width</i>
Máximo <i>Maximum</i>	1298 mm	2800 mm
Mínimo <i>Minimum</i>	138 mm	100 mm
VETA / Grain HORIZONTAL	ALTURA <i>Height</i>	ANCHO <i>Width</i>
Máximo <i>Maximum</i>	1298 mm	1298 mm
Mínimo <i>Minimum</i>	138 mm	100 mm
VETA / Grain VERTICAL	ALTURA <i>Height</i>	ANCHO <i>Width</i>
Máximo <i>Maximum</i>	1298 mm	1298 mm
Mínimo <i>Minimum</i>	138 mm	100 mm

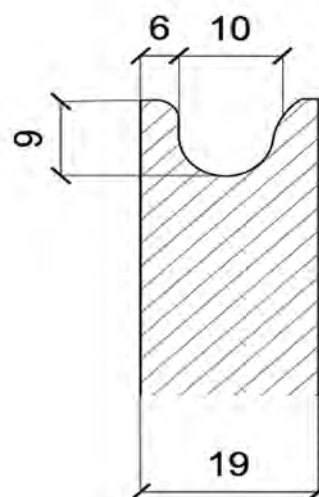

DISEÑOS MODELO ONEGA 19 mm

Onega 19 mm model designs



**Blanco polar
BLP-805 SEF**



**Nogal natural
ELN-915 VH**



**Roble claro
OAC-809 PW**



**Roble elegance
OAD-822 FUN**



**Roble aneto
OAN-807 FUN**



**Roble tostado
OAT-808 PW**

MODELO ONEGA 22 mm

Onega 22 mm model

■ CARACTERÍSTICAS TÉCNICAS:

Terminación: canto superior con perfil tirador postformado tipo "U" y cantos rectos en ABS de igual color del frente.
 Soporte: tablero aglomerado.
 Recubrimiento: melamina decorativa acabada en mate y film protector.
 Diseños en madera con veta horizontal.
 Contracara: similar acabado soft.
 Adhesivo: resina melaminica.
 Espesor: 22 mm.

■ FEATURES:

Finish: top edge with postforming profile handle type "U" and straight edges in ABS of the same front color.
 Core: particle board.
 Covering: decorative melamine matt finish and protective film.
 Wood designs with horizontal grain.
 Backside: similar colour soft finish.
 Adhesive: melamine resin.
 Thickness: 22 mm.



MEDIDAS DE PUERTAS Doors measures		
UNICOLORES <i>Unicolors</i>	ALTURA <i>Height</i>	ANCHO <i>Width</i>
Máximo <i>Maximum</i>	1298 mm	2800 mm
Mínimo <i>Minimum</i>	138 mm	100 mm
VETA / Grain HORIZONTAL	ALTURA <i>Height</i>	ANCHO <i>Width</i>
Máximo <i>Maximum</i>	1298 mm	1298 mm
Mínimo <i>Minimum</i>	138 mm	100 mm
VETA / Grain VERTICAL	ALTURA <i>Height</i>	ANCHO <i>Width</i>
Máximo <i>Maximum</i>	1298 mm	1298 mm
Mínimo <i>Minimum</i>	138 mm	100 mm

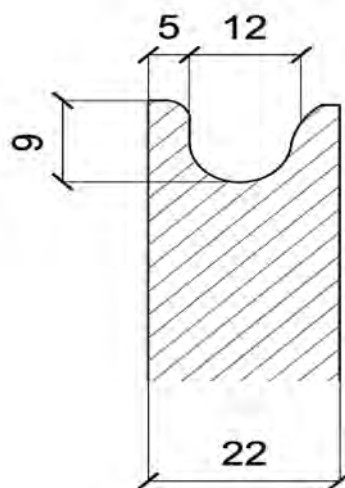

DISEÑOS MODELO ONEGA 22 mm

Onega 22 mm model designs

PUERTAS, COSTADOS Y REGLETAS / Doors, cover panels and fillers



**Aguamarina
AGM-834 SEF**



**Arena
ARB-810 SEF**



**Arena claro
ARC-837 SOFT**



**Blanco fresno
BLC-853 PF**



**Blanco polar
BLP-805 SEF**



**Cacao chocolate
CAC-839 SOFT**



**Nogal rústico
CLC-828 SYNCH**



**Nogal alfil
CLN-829 SYNCH**



**Nogal pacífico
CLO-826 SYNCH**



**Nogal negro
ENC-821 SPIRIT**



**Nogal italiano
EXP-823 SPIRIT**



**Gris antacita
GAN-811 SEF**

DISEÑOS MODELO ONEGA 22 mm*Onega 22 mm model designs*

Negro
GLP-283 SOFT



Negro
GLP-283 SOFT



Roble nudos blanco
HFX-176 RG



Roble nudos natural
HFX-180 RG



Roble nudos tabaco
HFX-181 RG



Roble nudos tabaco
HFX-181 RG



Roble café
MES-799 V.V



Roble avellana
OAM-806 FUN



Olmo tostado
PNH-003 RG



Olmo natural
PNH-004 RG



Rojo
RED-840 SOFT



Roble miel
RHO-027 RG

DISEÑOS MODELO ONEGA 22 mm

Onega 22 mm model designs



**Roble coñac
RSC-833 RG**



**Roble azucar
RSO-029 RG**



**Teja
RTE-835 SOFT**



**Roble tropical
SON-798 V.V**



**Nogal tostado
TOS-824 RG**

MODELO TAJO 22 mm

Tajo 22 mm model

■ CARACTERÍSTICAS TÉCNICAS:

Terminación: enmarcada con marco simétrico de 80 mm y plafón remetido, cantos rectos en ABS de igual color del frente.

Soporte: tablero aglomerado.

Recubrimiento: melamina decorativa con veta vertical acabada en mate.

Contracara: similar acabado soft.

Adhesivo: resina melaminica.

Espesor: 22 mm.

■ FEATURES:

Finish: framed with 80 mm symmetrical frame and recessed flat panel and straight edges in ABS of the same front color.

Core: particle board.

Covering: decorative melamine matt finish with vertical grain.

Backside: similar colour soft finish.

Adhesive: melamine resin.

Thickness: 22 mm.



MEDIDAS DE PUERTAS Doors measures		
UNICOLORS Unicolors	ALTURA Height	ANCHO Width
Máximo Maximum	—	—
Mínimo Minimum	—	—
VETA / Grain VERTICAL	ALTURA Height	ANCHO Width
Máximo Maximum	2400 mm	1197 mm
Mínimo Minimum	278 mm	297 mm
VETA / Grain HORIZONTAL	ALTURA Height	ANCHO Width
Máximo Maximum	—	—
Mínimo Minimum	—	—

Nota: toda medida inferior a 278x297 mm no irá enmarcada, será una pieza lisa a 4 cantos (ejemplo: frente cajón 173x597 mm).

Note: any measurement less than 278x297 mm will not be framed, it will be a smooth piece with 4 edges (example: front drawer 173x597 mm).

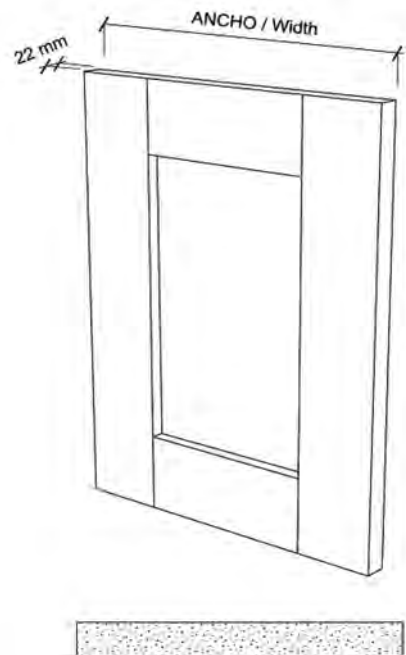

DISEÑOS MODELO TAJO 22 mm

Tajo 22 mm model designs



Nogal negro
ENC-821 SPIRIT



Roble nudos blanco
HFX-176 RG



Roble nudos natural
HFX-180 RG



Roble nudos tabaco
HFX-181 RG



Roble nudos zinc
HFX-376 RG



Roble coñac
RSC-833 RG

MODELO LOIRA 19 mm

Loira 19 mm model

■ CARACTERÍSTICAS TÉCNICAS:

Terminación: enmarcada con marco asimétrico y plafón remetido, cantos rectos en ABS de igual color del frente.

Soporte: tablero aglomerado.

Recubrimiento: melamina decorativa con veta vertical acabada en mate.

Contracara: similar acabado soft.

Adhesivo: resina melaminica.

Espesor: 19 mm.

■ FEATURES:

Finish: framed with asymmetric frame and recessed flat panel and straight edges in ABS of the same front color.

Core: particle board.

Covering: decorative melamine matt finish with vertical grain.

Backside: similar colour soft finish.

Adhesive: melamine resin.

Thickness: 19 mm.



MEDIDAS DE PUERTAS Doors measures		
UNICOLORES <i>Unicolors</i>	ALTURA <i>Height</i>	ANCHO <i>Width</i>
Máximo <i>Maximum</i>	—	—
Mínimo <i>Minimum</i>	—	—
VETA / Grain VERTICAL	ALTURA <i>Height</i>	ANCHO <i>Width</i>
Máximo <i>Maximum</i>	2400 mm	1197 mm
Mínimo <i>Minimum</i>	278 mm	297 mm
VETA / Grain HORIZONTAL	ALTURA <i>Height</i>	ANCHO <i>Width</i>
Máximo <i>Maximum</i>	—	—
Mínimo <i>Minimum</i>	—	—

Nota: toda medida inferior a 278x297 mm no irá enmarcada, será una pieza lisa a 4 cantos (ejemplo: frente cajón 173x597 mm).

Note: any measurement less than 278x297 mm will not be framed, it will be a smooth piece with 4 edges (example: front drawer 173x597 mm).

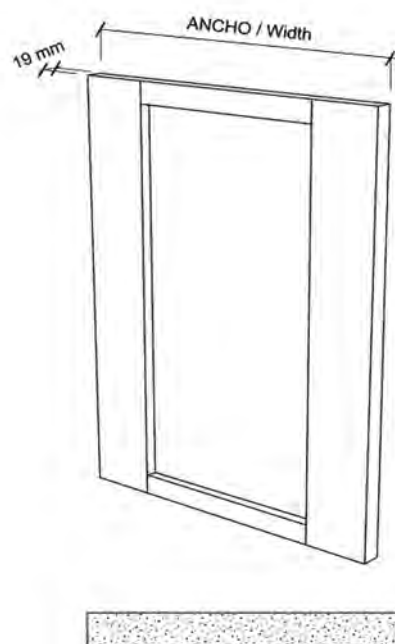

DISEÑOS MODELO LOIRA 19 mm

Loira 19 mm model designs



Roble nudos natural
HFX-180 RG



Blanco margarita
LEB-851 VETA



Gris margarita
LEG-850 VETA

MODELO SENA 19 mm

Sena 19 mm model

■ CARACTERÍSTICAS TÉCNICAS:

Terminación: canto superior acanalado con tirador integrado en aluminio modelo "ALTAMIRA" y cantos rectos en ABS de igual color a la puerta.

Acabado tirador integrado: plata mate, inox, y blanco.

Soporte: tablero aglomerado.

Recubrimiento: melamina decorativa acabada en mate y film protector.

Diseños en madera con veta vertical.

Contracara: mismo color.

Adhesivo puerta: resina melaminica.

Adhesivo tirador: Express (cola de base acuosa).

Espesor: 19 mm.

■ FEATURES:

Finish: ribbed upper edge with integrated aluminum handle "ALTAMIRA" model and straight edges in ABS of equal color to the door.

Integrated handle finish: matt silver, stainless steel and white.

Core: particle board.

Covering: decorative melamine matt finish and protective film.

Wood designs with vertical grain.

Backside: same color.

Door adhesive: melamine resin.

Handle adhesive: Express (water based glue).

Thickness: 19 mm.



MEDIDAS DE PUERTAS Doors measures		
UNICOLORES <i>Unicolors</i>	ALTURA <i>Height</i>	ANCHO <i>Width</i>
Máximo <i>Maximum</i>	2800 mm	1197 mm
Mínimo <i>Minimum</i>	130 mm	147 mm
VETA / Grain VERTICAL	ALTURA <i>Height</i>	ANCHO <i>Width</i>
Máximo <i>Maximum</i>	2800 mm	1197 mm
Mínimo <i>Minimum</i>	130 mm	147 mm
VETA / Grain HORIZONTAL	ALTURA <i>Height</i>	ANCHO <i>Width</i>
Máximo <i>Maximum</i>	1498 mm	1197 mm
Mínimo <i>Minimum</i>	130 mm	147 mm

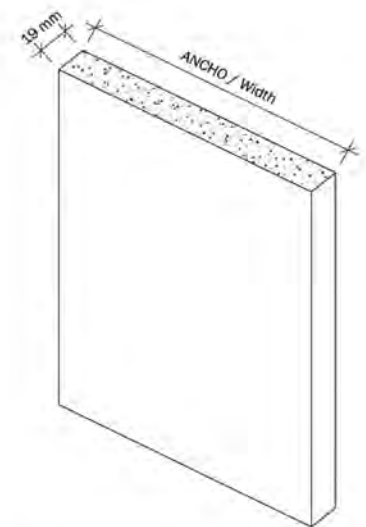
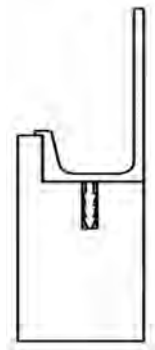

DISEÑOS MODELO SENA 19 mm

Sena 19 mm model designs

PUERTAS, COSTADOS Y REGLETAS / Doors, cover panels and fillers



**Aguamarina
AGM-834 SEF**



**Arena
ARB-810 SEF**



**Arena claro
ARC-837 SOFT**



**Blanco fresno
BLC-853 PF**



**Blanco polar
BLP-805 SEF**



**Cacao chocolate
CAC-839 SOFT**



**Nogal rústico
CLC-828 SYNCH**



**Nogal alfil
CLN-829 SYNCH**



**Nogal pacífico
CLO-826 SYNCH**



**Nogal natural
ELN-915 VH**



**Nogal negro
ENC-821 SPIRIT**



**Nogal italiano
EXP-823 SPIRIT**

DISEÑOS MODELO SENA 19 mm

Sena 19 mm model designs



Gris antacita
GAN-811 SEF



Negro
GLP-283 SOFT



Gris claro
GRC-836 SOFT



Roble nudos blanco
HFX-176 RG



Roble nudos natural
HFX-180 RG



Roble nudos tabaco
HFX-181 RG



Roble nudos zinc
HFX-376 RG



Roble café
MES-799 V.V



Roble claro
OAC-809 PW



Roble elegance
OAD-822 FUN



Roble elegance
OAD-822 FUN



Roble aneto
OAN-807 FUN

DISEÑOS MODELO SENA 19 mm

Sena 19 mm model designs



**Roble tostado
OAT-808 PW**



**Olmo tostado
PNH-003 RG**



**Olmo natural
PNH-004 RG**



**Rojo
RED-840 SOFT**



**Roble miel
RHO-027 RG**



**Roble coñac
RSC-833 RG**



**Roble azucar
RSO-029 RG**



**Teja
RTE-835 SOFT**



**Roble tropical
SON-798 V.V**



**Nogal tostado
TOS-824 RG**

PUERTAS, COSTADOS Y REGLETAS / Doors, cover panels and fillers

MODELO TÍBER 19 mm*Tiber 19 mm model***■ CARACTERÍSTICAS TÉCNICAS:**

Terminación: canto inferior acanalado con tirador integrado en aluminio modelo "VENECIA" y cantos rectos en ABS de igual color a la puerta.

Acabado tirador integrado: plata mate, inox, y blanco.

Soporte: tablero aglomerado.

Recubrimiento: melamina decorativa acabada en mate y film protector.

Diseños en madera con veta vertical.

Contracara: mismo color.

Adhesivo puerta: resina melaminica.

Adhesivo tirador: Express (cola de base acuosa).

Espesor: 19 mm.

■ FEATURES:

Finish: ribbed nether edge with integrated aluminum handle "VENECIA" model and straight edges in ABS of equal color to the door.

Integrated handle finish: matt silver, stainless steel and white.

Core: particle board.

Covering: decorative melamine matt finish and protective film.

Wood designs with vertical grain.

Backside: same color.

Door adhesive: melamine resin.

Handle adhesive: Express (water based glue).

Thickness: 19 mm.



MEDIDAS DE PUERTAS <i>Doors measures</i>		
UNICOLORES <i>Unicolors</i>	ALTURA <i>Height</i>	ANCHO <i>Width</i>
Máximo <i>Maximum</i>	2800 mm	1197 mm
Mínimo <i>Minimum</i>	130 mm	147 mm
VETA / Grain VERTICAL	ALTURA <i>Height</i>	ANCHO <i>Width</i>
Máximo <i>Maximum</i>	2800 mm	1197 mm
Mínimo <i>Minimum</i>	130 mm	147 mm
VETA / Grain HORIZONTAL	ALTURA <i>Height</i>	ANCHO <i>Width</i>
Máximo <i>Maximum</i>	1498 mm	1197 mm
Mínimo <i>Minimum</i>	130 mm	147 mm

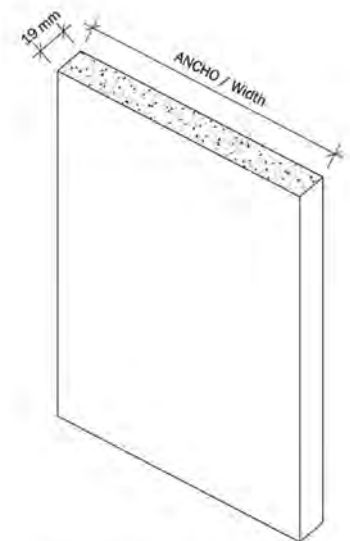
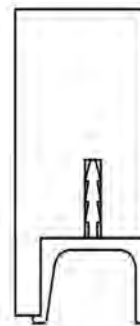

DISEÑOS MODELO TÍBER 19 mm

Tiber 19 mm model designs



**Aguamarina
AGM-834 SEF**



**Arena
ARB-810 SEF**



**Arena claro
ARC-837 SOFT**



**Blanco fresno
BLC-853 PF**



**Blanco polar
BLP-805 SEF**



**Cacao chocolate
CAC-839 SOFT**



**Nogal rústico
CLC-828 SYNCH**



**Nogal alfil
CLN-829 SYNCH**



**Nogal pacífico
CLO-826 SYNCH**



**Nogal natural
ELN-915 VH**



**Nogal negro
ENC-821 SPIRIT**



**Nogal italiano
EXP-823 SPIRIT**

PUERTAS, COSTADOS Y REGLETAS / Doors, cover panels and fillers

DISEÑOS MODELO TÍBER 19 mm

Tiber 19 mm model designs



Gris antacita
GAN-811 SEF



Negro
GLP-283 SOFT



Gris claro
GRC-836 SOFT



Roble nudos blanco
HFX-176 RG



Roble nudos natural
HFX-180 RG



Roble nudos tabaco
HFX-181 RG



Roble nudos zinc
HFX-376 RG



Roble café
MES-799 V.V



Roble claro
OAC-809 PW



Roble elegance
OAD-822 FUN



Roble avellana
OAM-806 FUN



Roble avellana
OAM-806 FUN

DISEÑOS MODELO TÍBER 19 mm

Tiber 19 mm model designs



**Roble tostado
OAT-808 PW**



**Olmo tostado
PNH-003 RG**



**Olmo natural
PNH-004 RG**



**Rojo
RED-840 SOFT**



**Roble miel
RHO-027 RG**



**Roble coñac
RSC-833 RG**



**Roble azucar
RSO-029 RG**



**Teja
RTE-835 SOFT**



**Roble tropical
SON-798 V.V**



**Nogal tostado
TOS-824 RG**

PUERTAS, COSTADOS Y REGLETAS / Doors, cover panels and fillers

MODELO RIN 19 mm

Rin 19 mm model

■ CARACTERÍSTICAS TÉCNICAS:

Terminación: canto superior acanalado con tirador integrado en aluminio modelo "BRUJAS" y cantos rectos en ABS de igual color a la puerta.

Acabado tirador integrado: inox look.

Soporte: tablero aglomerado.

Recubrimiento: melamina decorativa acabada en mate y film protector.

Diseños en madera con veta vertical.

Contracara: mismo color.

Adhesivo puerta: resina melaminica.

Adhesivo tirador: Express (cola de base acuosa).

Espesor: 19 mm.

■ FEATURES:

Finish: ribbed upper edge with integrated aluminum handle "BRUJAS" model and straight edges in ABS of equal color to the door.

Integrated handle finish: stainless steel look.

Core: particle board.

Covering: decorative melamine matt finish and protective film.

Wood designs with vertical grain.

Backside: same color.

Door adhesive: melamine resin.

Handle adhesive: Express (water based glue).

Thickness: 19 mm.



MEDIDAS DE PUERTAS Doors measures		
UNICOLORES <i>Unicolors</i>	ALTURA <i>Height</i>	ANCHO <i>Width</i>
Máximo <i>Maximum</i>	2800 mm	1197 mm
Mínimo <i>Minimum</i>	130 mm	147 mm
VETA / Grain VERTICAL	ALTURA <i>Height</i>	ANCHO <i>Width</i>
Máximo <i>Maximum</i>	2800 mm	1197 mm
Mínimo <i>Minimum</i>	130 mm	147 mm
VETA / Grain HORIZONTAL	ALTURA <i>Height</i>	ANCHO <i>Width</i>
Máximo <i>Maximum</i>	1198 mm	1197 mm
Mínimo <i>Minimum</i>	130 mm	147 mm

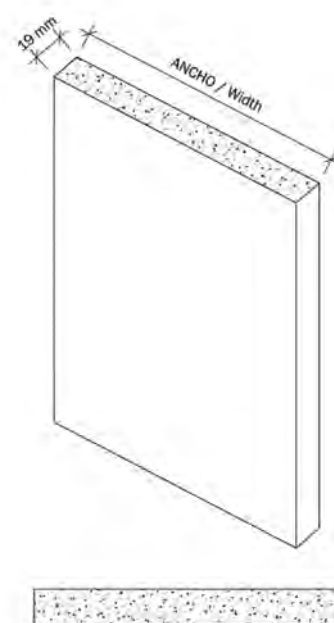
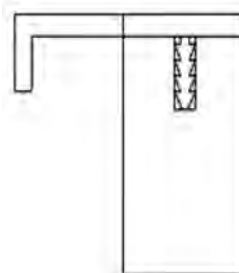

DISEÑOS MODELO RIN 19 mm

Rin 19 mm model designs

PUERTAS, COSTADOS Y REGLETAS / Doors, cover panels and fillers



**Aguamarina
AGM-834 SEF**



**Arena
ARB-810 SEF**



**Arena claro
ARC-837 SOFT**



**Blanco fresno
BLC-853 PF**



**Blanco polar
BLP-805 SEF**



**Cacao chocolate
CAC-839 SOFT**



**Nogal rústico
CLC-828 SYNCH**



**Nogal alfil
CLN-829 SYNCH**



**Nogal pacífico
CLO-826 SYNCH**



**Nogal natural
ELN-915 VH**



**Nogal negro
ENC-821 SPIRIT**



**Nogal italiano
EXP-823 SPIRIT**

DISEÑOS MODELO RIN 19 mm

Rin 19 mm model designs



Gris antacita
GAN-811 SEF



Negro
GLP-283 SOFT



Gris claro
GRC-836 SOFT



Roble nudos blanco
HFX-176 RG



Roble nudos natural
HFX-180 RG



Roble nudos tabaco
HFX-181 RG



Roble nudos zinc
HFX-376 RG



Roble café
MES-799 V.V



Roble claro
OAC-809 PW



Roble elegance
OAD-822 FUN



Roble avellana
OAM-806 FUN



Roble aneto
OAN-807 FUN

DISEÑOS MODELO RIN 19 mm

Rin 19 mm model designs



**Roble tostado
OAT-808 PW**



**Olmo tostado
PNH-003 RG**



**Olmo natural
PNH-004 RG**



**Rojo
RED-840 SOFT**



**Roble miel
RHO-027 RG**



**Roble coñac
RSC-833 RG**



**Roble azucar
RSO-029 RG**



**Teja
RTE-835 SOFT**



**Roble tropical
SON-798 V.V**



**Nogal tostado
TOS-824 RG**

PUERTAS, COSTADOS Y REGLETAS / Doors, cover panels and fillers

MODELO DUERO 19 mm

Duero 19 mm model

■ CARACTERÍSTICAS TÉCNICAS:

Terminación: canto superior acanalado con tirador integrado en aluminio modelo "LISBOA" y cantos rectos en ABS de igual color a la puerta.

Acabado tirador integrado: inox look.

Soporte: tablero aglomerado.

Recubrimiento: melamina decorativa acabada en mate y film protector.

Diseños en madera con veta vertical.

Contracara: mismo color.

Adhesivo puerta: resina melaminica.

Adhesivo tirador: Express (cola de base acuosa).

Espesor: 19 mm.

■ FEATURES:

Finish: ribbed upper edge with integrated aluminum handle "LISBOA" model and straight edges in ABS of equal color to the door.

Integrated handle finish: stainless steel look.

Core: particle board.

Covering: decorative melamine matt finish and protective film.

Wood designs with vertical grain.

Backside: same color.

Door adhesive: melamine resin.

Handle adhesive: Express (water based glue).

Thickness: 19 mm.



MEDIDAS DE PUERTAS Doors measures		
UNICOLORES <i>Unicolors</i>	ALTURA <i>Height</i>	ANCHO <i>Width</i>
Máximo <i>Maximum</i>	2800 mm	1197 mm
Mínimo <i>Minimum</i>	130 mm	147 mm
VETA / Grain VERTICAL	ALTURA <i>Height</i>	ANCHO <i>Width</i>
Máximo <i>Maximum</i>	2800 mm	1197 mm
Mínimo <i>Minimum</i>	130 mm	147 mm
VETA / Grain HORIZONTAL	ALTURA <i>Height</i>	ANCHO <i>Width</i>
Máximo <i>Maximum</i>	1198 mm	1197 mm
Mínimo <i>Minimum</i>	130 mm	147 mm

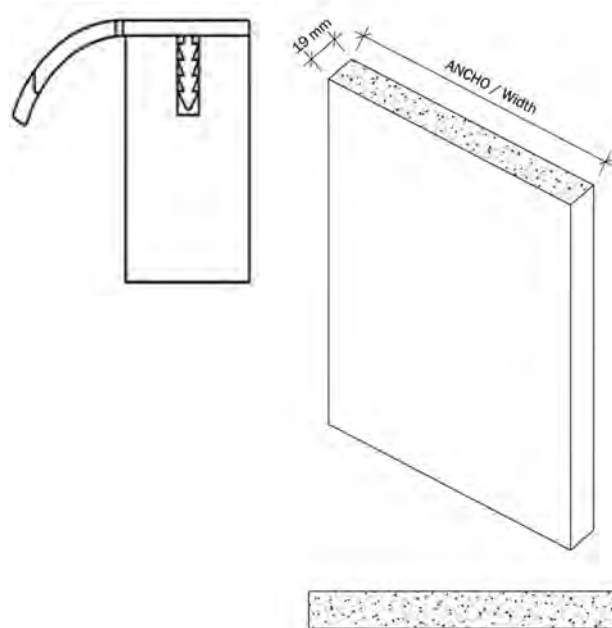

DISEÑOS MODELO DUERO 19 mm

Duero 19 mm model designs



**Aguamarina
AGM-834 SEF**



**Arena
ARB-810 SEF**



**Arena claro
ARC-837 SOFT**



**Blanco fresno
BLC-853 PF**



**Blanco polar
BLP-805 SEF**



**Cacao chocolate
CAC-839 SOFT**



**Nogal rústico
CLC-828 SYNCH**



**Nogal alfil
CLN-829 SYNCH**



**Nogal pacífico
CLO-826 SYNCH**



**Nogal natural
ELN-915 VH**



**Nogal negro
ENC-821 SPIRIT**



**Nogal italiano
EXP-823 SPIRIT**

PUERTAS, COSTADOS Y REGLETAS / Doors, cover panels and fillers

DISEÑOS MODELO DUERO 19 mm

Duero 19 mm model designs



Gris antacita
GAN-811 SEF



Negro
GLP-283 SOFT



Gris claro
GRC-836 SOFT



Roble nudos blanco
HFX-176 RG



Roble nudos natural
HFX-180 RG



Roble nudos tabaco
HFX-181 RG



Roble nudos zinc
HFX-376 RG



Roble café
MES-799 V.V



Roble claro
OAC-809 PW



Roble elegace
OAD-822 FUN



Roble avellana
OAM-806 FUN



Roble aneto
OAN-807 FUN

DISEÑOS MODELO DUERO 19 mm

Duero 19 mm model designs



**Roble tostado
OAT-808 PW**



**Olmo tostado
PNH-003 RG**



**Olmo natural
PNH-004 RG**



**Rojo
RED-840 SOFT**



**Roble miel
RHO-027 RG**



**Roble coñac
RSC-833 RG**



**Roble azucar
RSO-029 RG**



**Teja
RTE-835 SOFT**



**Roble tropical
SON-798 V.V**



**Nogal tostado
TOS-824 RG**

PUERTAS, COSTADOS Y REGLETAS / Doors, cover panels and fillers

MODELO SAONA 19 mm

Saona 19 mm model

■ CARACTERÍSTICAS TÉCNICAS:

Terminación: canto superior acanalado con tirador integrado 45° en aluminio modelo "SAONA" y cantos rectos en ABS de igual color a la puerta.

Acabado tirador integrado: inox look.

Soporte: tablero aglomerado.

Recubrimiento: melamina decorativa acabada en mate y film protector.

Diseños en madera con veta vertical.

Contracara: mismo color.

Adhesivo puerta: resina melaminica.

Adhesivo tirador: Express (cola de base acuosa).

Espesor: 19 mm.

■ FEATURES:

Finish: 45° ribbed upper edge with integrated aluminum handle "SAONA" model and straight edges in ABS of equal color to the door.

Integrated handle finish: stainless steel look.

Core: particle board.

Covering: decorative melamine matt finish and protective film.

Wood designs with vertical grain.

Backside: same color.

Door adhesive: melamine resin.

Handle adhesive: Express (water based glue).

Thickness: 19 mm.



MEDIDAS DE PUERTAS Doors measures		
UNICOLORES <i>Unicolors</i>	ALTURA <i>Height</i>	ANCHO <i>Width</i>
Máximo <i>Maximum</i>	2800 mm	1197 mm
Mínimo <i>Minimum</i>	130 mm	147 mm
VETA / Grain VERTICAL	ALTURA <i>Height</i>	ANCHO <i>Width</i>
Máximo <i>Maximum</i>	2800 mm	1197 mm
Mínimo <i>Minimum</i>	130 mm	147 mm
VETA / Grain HORIZONTAL	ALTURA <i>Height</i>	ANCHO <i>Width</i>
Máximo <i>Maximum</i>	1498 mm	1197 mm
Mínimo <i>Minimum</i>	130 mm	147 mm

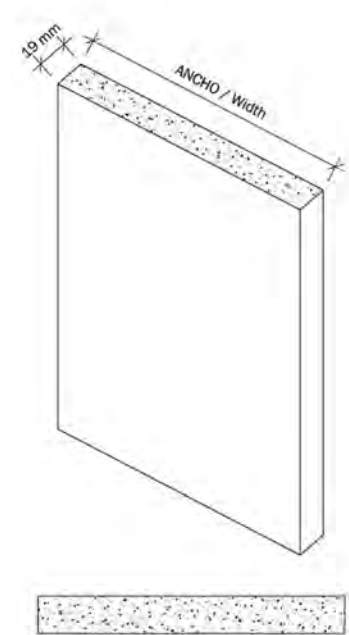

DISEÑOS MODELO SAONA 19 mm

Saona 19 mm model designs

PUERTAS, COSTADOS Y REGLETAS / Doors, cover panels and fillers



Aguamarina
AGM-834 SEF



Arena
ARB-810 SEF



Arena claro
ARC-837 SOFT



Blanco fresno
BLC-853 PF



Blanco polar
BLP-805 SEF



Cacao chocolate
CAC-839 SOFT



Nogal rústico
CLC-828 SYNCH



Nogal alfil
CLN-829 SYNCH



Nogal pacífico
CLO-826 SYNCH



Nogal natural
ELN-915 VH



Nogal negro
ENC-821 SPIRIT



Nogal italiano
EXP-823 SPIRIT

DISEÑOS MODELO SAONA 19 mm

Saona 19 mm model designs



Gris antacita
GAN-811 SEF



Negro
GLP-283 SOFT



Gris claro
GRC-836 SOFT



Roble nudos blanco
HFX-176 RG



Roble nudos natural
HFX-180 RG



Roble nudos tabaco
HFX-181 RG



Roble nudos zinc
HFX-376 RG



Roble café
MES-799 V.V



Roble claro
OAC-809 PW



Roble elegance
OAD-822 FUN



Roble avellana
OAM-806 FUN



Roble aneto
OAN-807 FUN

DISEÑOS MODELO SAONA 19 mm

Saona 19 mm model designs



**Roble tostado
OAT-808 PW**



**Olmo tostado
PNH-003 RG**



**Olmo natural
PNH-004 RG**



**Rojo
RED-840 SOFT**



**Roble miel
RHO-027 RG**



**Roble coñac
RSC-833 RG**



**Roble azucar
RSO-029 RG**



**Teja
RTE-835 SOFT**



**Roble tropical
SON-798 V.V**



**Nogal tostado
TOS-824 RG**

PUERTAS, COSTADOS Y REGLETAS / Doors, cover panels and fillers

MODELO SAONA 22 mm

Saona 22 mm model

■ CARACTERÍSTICAS TÉCNICAS:

Terminación: canto superior acanalado con tirador integrado 45° en aluminio modelo "SAONA" y cantos rectos en ABS de igual color a la puerta.

Acabado tirador integrado: inox look.

Soporte: tablero aglomerado.

Recubrimiento: melamina decorativa acabada en mate y film protector.

Diseños en madera con veta vertical.

Contracara: mismo color.

Adhesivo puerta: resina melaminica.

Adhesivo tirador: Express (cola de base acuosa).

Espesor: 22 mm.

■ FEATURES:

Finish: 45° ribbed upper edge with integrated aluminum handle "SAONA" model and straight edges in ABS of equal color to the door.

Integrated handle finish: stainless steel look.

Core: particle board.

Covering: decorative melamine matt finish and protective film.

Wood designs with vertical grain.

Backside: same color.

Door adhesive: melamine resin.

Handle adhesive: Express (water based glue).

Thickness: 22 mm.



MEDIDAS DE PUERTAS Doors measures		
UNICOLORES <i>Unicolors</i>	ALTURA <i>Height</i>	ANCHO <i>Width</i>
Máximo <i>Maximum</i>	2800 mm	1197 mm
Mínimo <i>Minimum</i>	130 mm	147 mm
VETA / Grain VERTICAL	ALTURA <i>Height</i>	ANCHO <i>Width</i>
Máximo <i>Maximum</i>	2800 mm	1197 mm
Mínimo <i>Minimum</i>	130 mm	147 mm
VETA / Grain HORIZONTAL	ALTURA <i>Height</i>	ANCHO <i>Width</i>
Máximo <i>Maximum</i>	1498 mm	1197 mm
Mínimo <i>Minimum</i>	130 mm	147 mm

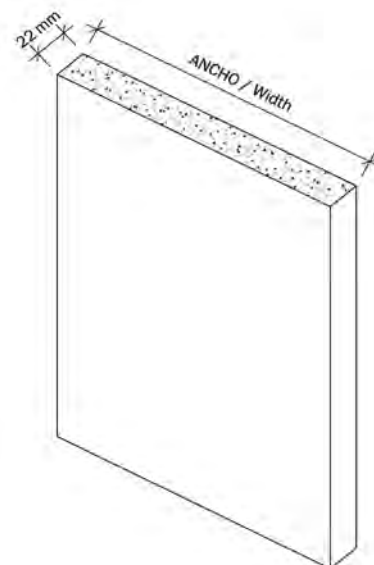
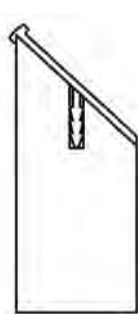

DISEÑOS MODELO SAONA 22 mm

Saona 22 mm model designs



**Aguamarina
AGM-834 SEF**



**Arena
ARB-810 SEF**



**Arena claro
ARC-837 SOFT**



**Blanco fresno
BLC-853 PF**



**Blanco polar
BLP-805 SEF**



**Cacao chocolate
CAC-839 SOFT**



**Nogal rústico
CLC-828 SYNCH**



**Nogal alfil
CLN-829 SYNCH**



**Nogal pacífico
CLO-826 SYNCH**



**Nogal negro
ENC-821 SPIRIT**



**Nogal italiano
EXP-823 SPIRIT**



**Gris antacita
GAN-811 SEF**

PUERTAS, COSTADOS Y REGLETAS / Doors, cover panels and fillers

DISEÑOS MODELO SAONA 22 mm

Saona 22 mm model designs



Negro
GLP-283 SOFT



Gris claro
GRC-836 SOFT



Roble nudos blanco
HFX-176 RG



Roble nudos natural
HFX-180 RG



Roble nudos tabaco
HFX-181 RG



Roble nudos zinc
HFX-376 RG



Roble café
MES-799 V.V



Roble avellana
OAM-806 FUN



Olmo tostado
PNH-003 RG



Olmo natural
PNH-004 RG



Rojo
RED-840 SOFT



Roble miel
RHO-027 RG

DISEÑOS MODELO SAONA 22 mm

Saona 22 mm model designs



**Roble coñac
RSC-833 RG**



**Roble azucar
RSO-029 RG**



**Teja
RTE-835 SOFT**



**Roble tropical
SON-798 V.V**



**Nogal tostado
TOS-824 RG**

B.

extreme hpl



TOP FORM

MODELO ELBA 19 mm

Elba 19 mm model

■ CARACTERÍSTICAS TÉCNICAS:

Terminación: cuatro cantos en ABS de igual color del frente.
 Soporte: tablero aglomerado.
 Recubrimiento: laminado decorativo HPL de 0,7 mm espesor acabado en brillo y film protector. Diseños en madera con veta vertical.
 Contracara: mismo color.
 Adhesivo: cola PUR (poliuretano reactivo prensado en frio).
 Espesor: 19 mm.

■ FEATURES:

Finish: four edges in ABS of the same front color.
 Core: particle board.
 Covering: 0,7 mm thick decorative HPL laminate shiny finish and protective film. Wood designs with vertical grain.
 Backside: same colour.
 Adhesive: PUR glue (old press reactive polyurethane).
 Thickness: 19 mm.



MEDIDAS DE PUERTAS Doors measures		
UNICOLORES <i>Unicolors</i>	ALTURA <i>Height</i>	ANCHO <i>Width</i>
Máximo <i>Maximum</i>	3000 mm	1197 mm
Mínimo <i>Minimum</i>	100 mm	100 mm
VETA / Grain VERTICAL	ALTURA <i>Height</i>	ANCHO <i>Width</i>
Máximo <i>Maximum</i>	3000 mm	1197 mm
Mínimo <i>Minimum</i>	100 mm	100 mm
VETA / Grain HORIZONTAL	ALTURA <i>Height</i>	ANCHO <i>Width</i>
Máximo <i>Maximum</i>	1498 mm	1197 mm
Mínimo <i>Minimum</i>	100 mm	100 mm

Nota: diseños marcados con asterisco (*) disponible con terminación en cuatro cantos **CRISTAL ALUMINIO**.

Note: Designs marked with an asterisk (*) available termination four edges **CRISTAL ALUMINUM**.

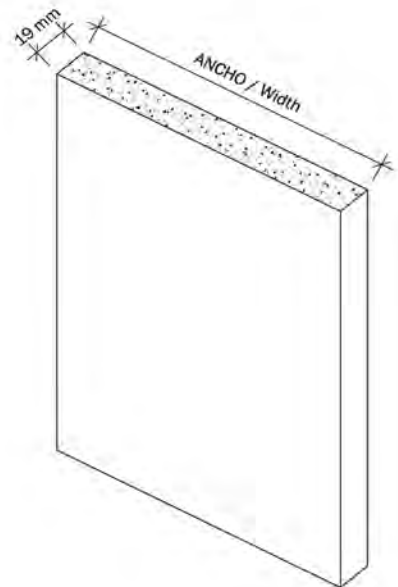

DISEÑOS MODELO ELBA 19 mm

Elba 19 mm model designs



Blanco
3091 BRILLO *



Blanco Islandia
3091 SEF



Pistacho
COV-222 BRILLO *



Burdeos
GLB-247 BRILLO *



Crema Suave
GLC-158 BRILLO *



Gris
GLG-400 BRILLO *



Aluminio
GLI-159 BRILLO



Berenjena
GLK-401 BRILLO *



Berenjena
GLK-401 BRILLO *



Rojo escarlata
GLR-244 BRILLO *



Café
GLS-248 BRILLO *



Cacao maní
INA-814 NDF

PUERTAS, COSTADOS Y REGLETAS / Doors, cover panels and fillers

DISEÑOS MODELO ELBA 19 mm

Elba 19 mm model designs



Blanco Groenlandia
INB-812 NDF



Blanco Groenlandia
INB-812 NDF



Marquina gris
INM-817 NDF



Negro profundo
INN-816 NDF



Café mokachino
INP-813 NDF



Grafito
INT-815 NDF



Talco
LAR-770 SOFT



Mármol marquina
MAC-820 STUCCO



Mármol emperador
MAY-819 STUCCO



Gris metálico
MTG-765 BRILLO



Óxido azul
OXA-445 WAX



Óxido marrón
OXM-444 WAX

DISEÑOS MODELO ELBA 19 mm

Elba 19 mm model designs



**Pino kenia
PIR-022 SOFT**



**Pino viejo
PIV-023 SOFT**



**Roble natural
RON-803 OP**



**Cemento
TRC-443 WAX**

MODELO SENA 19 mm

Sena 19 mm model

■ CARACTERÍSTICAS TÉCNICAS:

Terminación: canto superior acanalado con tirador integrado en aluminio modelo "ALTAMIRA" y cantos rectos en ABS de igual color a la puerta.

Acabado tirador integrado: plata mate, inox y blanco.

Soporte: tablero aglomerado.

Recubrimiento: laminado decorativo HPL de 0,7 mm espesor acabado en brillo y film protector. Diseños en madera con veta vertical.

Contracara laminado idem.

Adhesivo: cola PUR (poliuretano reactivo prensado en frio).

Adhesivo tirador: Express (cola de base acuosa).

Espesor: 19 mm.

■ FEATURES:

Finish: ribbed upper edge with integrated aluminum handle "ALTAMIRA" model and straight edges in ABS of equal color to the door.

Integrated handle finish: matt silver, stainless steel and white.

Core: particle board.

Covering: 0,7 mm thick decorative HPL laminate shiny finish and protective film. Wood designs with vertical grain.

Backside laminate Idem.

Adhesive: PUR glue (old press reactive polyurethane).

Handle adhesive: Express (water based glue).

Thickness: 19 mm.



MEDIDAS DE PUERTAS Doors measures		
UNICOLORES <i>Unicolors</i>	ALTURA <i>Height</i>	ANCHO <i>Width</i>
Máximo <i>Maximum</i>	3000 mm	1197 mm
Mínimo <i>Minimum</i>	130 mm	147 mm
VETA / Grain VERTICAL	ALTURA <i>Height</i>	ANCHO <i>Width</i>
Máximo <i>Maximum</i>	3000 mm	1197 mm
Mínimo <i>Minimum</i>	130 mm	147 mm
VETA / Grain HORIZONTAL	ALTURA <i>Height</i>	ANCHO <i>Width</i>
Máximo <i>Maximum</i>	1498 mm	1197 mm
Mínimo <i>Minimum</i>	130 mm	147 mm

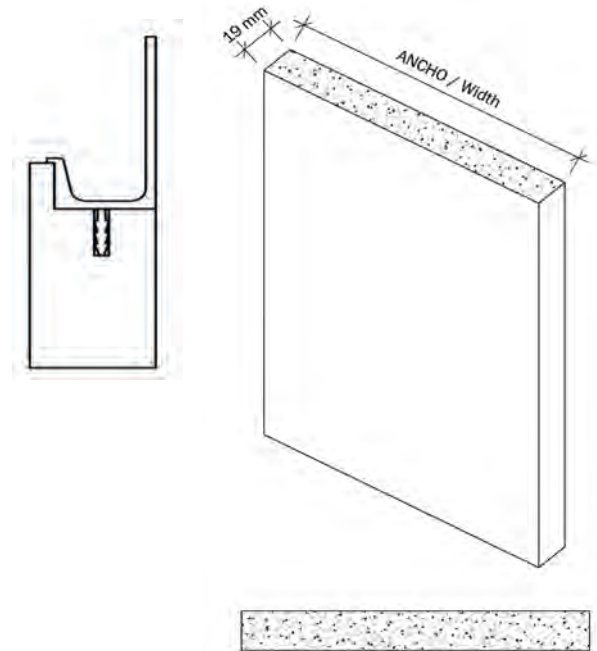

DISEÑOS MODELO SENA 19 mm

Sena 19 mm model designs



Blanco
3091 BRILLO



Blanco Islandia
3091 SEF



Pistacho
COV-222 BRILLO



Burdeos
GLB-247 BRILLO



Crema Suave
GLC-158 BRILLO



Gris
GLG-400 BRILLO



Aluminio
GLI-159 BRILLO



Berenjena
GLK-401 BRILLO



Negro
GLP-283 BRILLO



Rojo escarlata
GLR-244 BRILLO



Café
GLS-248 BRILLO



Cacao maní
INA-814 NDF

PUERTAS, COSTADOS Y REGLETAS / Doors, cover panels and fillers

DISEÑOS MODELO SENA 19 mm*Sena 19 mm model designs*

Blanco Groenlandia
INB-812 NDF



Calacatta
INC-818 NDF



Marquina gris
INM-817 NDF



Negro profundo
INN-816 NDF



Café mokachino
INP-813 NDF



Grafito
INT-815 NDF



Talco
LAR-770 SOFT



Mármol marquina
MAC-820 STUCCO



Mármol emperador
MAY-819 STUCCO



Gris metálico
MTG-765 BRILLO



Óxido azul
OXA-445 WAX



Óxido marrón
OXM-444 WAX

DISEÑOS MODELO SENA 19 mm

Sena 19 mm model designs



**Óxido marrón
OXM-444 WAX**



**Pino viejo
PIV-023 SOFT**



**Roble natural
RON-803 OP**



**Cemento
TRC-443 WAX**

MODELO TÍBER 19 mm*Tiber 19 mm model***■ CARACTERÍSTICAS TÉCNICAS:**

Terminación: canto inferior acanalado con tirador integrado en aluminio modelo "VENECIA" y cantos rectos en ABS de igual color a la puerta.

Acabado tirador integrado: plata mate, inox y blanco.

Soporte: tablero aglomerado.

Recubrimiento: laminado decorativo HPL de 0,7 mm espesor acabado en brillo y film protector. Diseños en madera con veta vertical.

Contracara laminado Idem.

Adhesivo: cola PUR (poliuretano reactivo prensado en frio).

Adhesivo tirador: Express (cola de base acuosa).

Espesor: 19 mm.

■ FEATURES:

Finish: ribbed nether edge with integrated aluminum handle "VENECIA" model and straight edges in ABS of equal color to the door.

Integrated handle finish: matt silver, stainless steel and white.

Core: particle board.

Covering: 0,7 mm thick decorative HPL laminate shiny finish and protective film. Wood designs with vertical grain.

Backside laminate Idem.

Adhesive: PUR glue (old press reactive polyurethane).

Handle adhesive: Express (water based glue).

Thickness: 19 mm.



MEDIDAS DE PUERTAS Doors measures		
UNICOLORES <i>Unicolors</i>	ALTURA <i>Height</i>	ANCHO <i>Width</i>
Máximo <i>Maximum</i>	3000 mm	1197 mm
Mínimo <i>Minimum</i>	130 mm	147 mm
VETA / Grain VERTICAL	ALTURA <i>Height</i>	ANCHO <i>Width</i>
Máximo <i>Maximum</i>	3000 mm	1197 mm
Mínimo <i>Minimum</i>	130 mm	147 mm
VETA / Grain HORIZONTAL	ALTURA <i>Height</i>	ANCHO <i>Width</i>
Máximo <i>Maximum</i>	1498 mm	1197 mm
Mínimo <i>Minimum</i>	130 mm	147 mm

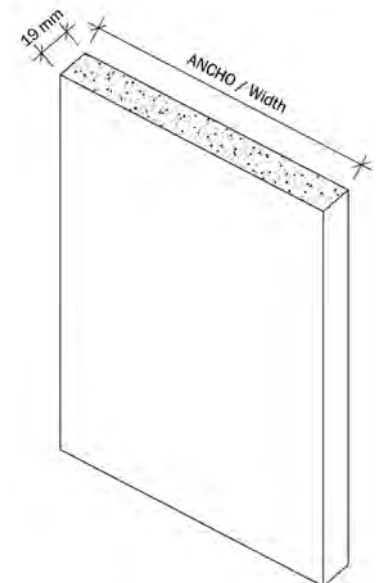
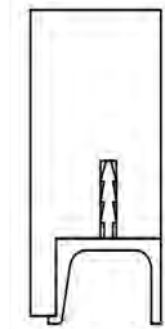

DISEÑOS MODELO TÍBER 19 mm

Tiber 19 mm model designs



Blanco
3091 BRILLO



Blanco Islandia
3091 SEF



Pistacho
COV-222 BRILLO



Burdeos
GLB-247 BRILLO



Crema Suave
GLC-158 BRILLO



Gris
GLG-400 BRILLO



Aluminio
GLI-159 BRILLO



Berenjena
GLK-401 BRILLO



Negro
GLP-283 BRILLO



Rojo escarlata
GLR-244 BRILLO



Café
GLS-248 BRILLO

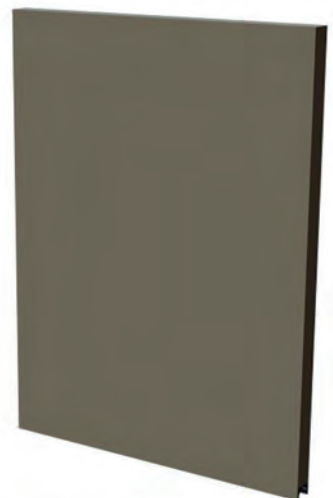

Cacao maní
INA-814 NDF

PUERTAS, COSTADOS Y REGLETAS / Doors, cover panels and fillers

DISEÑOS MODELO TÍBER 19 mm

Tiber 19 mm model designs



Blanco Groenlandia
INB-812 NDF



Calacatta
INC-818 NDF



Marquina gris
INM-817 NDF



Negro profundo
INN-816 NDF



Café mokachino
INP-813 NDF



Grafito
INT-815 NDF



Talco
LAR-770 SOFT



Mármol marquina
MAC-820 STUCCO

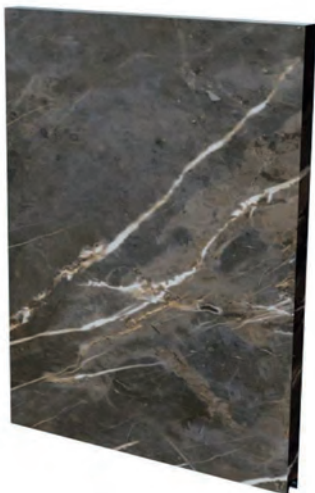

Mármol emperador
MAY-819 STUCCO



Gris metálico
MTG-765 BRILLO



Óxido azul
OXA-445 WAX



Óxido marrón
OXM-444 WAX

DISEÑOS MODELO TÍBER 19 mm

Tiber 19 mm model designs



**Pino kenia
PIR-022 SOFT**



**Pino viejo
PIV-023 SOFT**



**Roble natural
RON-803 OP**



**Cemento
TRC-443 WAX**

MODELO RIN 19 mm

Rin 19 mm model

■ CARACTERÍSTICAS TÉCNICAS:

Terminación: canto superior acanalado con tirador integrado en aluminio modelo "BRUJAS" y cantos rectos en ABS de igual color a la puerta.

Acabado tirador integrado: inox look.

Soporte: tablero aglomerado.

Recubrimiento: laminado decorativo HPL de 0,7 mm espesor acabado en brillo y film protector. Diseños en madera con veta vertical.

Contracara laminado Idem.

Adhesivo: cola PUR (poliuretano reactivo prensado en frio).

Adhesivo tirador: Express (cola de base acuosa).

Espesor: 19 mm.

■ FEATURES:

Finish: ribbed upper edge with integrated aluminum handle "BRUJAS" model and straight edges in ABS of equal color to the door.

Integrated handle finish: stainless look.

Core: particle board.

Covering: 0,7 mm thick decorative HPL laminate shiny finish and protective film. Wood designs with vertical grain.

Backside laminate Idem.

Adhesive: PUR glue (old press reactive polyurethane).

Handle adhesive: Express (water based glue).

Thickness: 19 mm.



MEDIDAS DE PUERTAS Doors measures		
UNICOLORES <i>Unicolors</i>	ALTURA <i>Height</i>	ANCHO <i>Width</i>
Máximo <i>Maximum</i>	3000 mm	1197 mm
Mínimo <i>Minimum</i>	130 mm	147 mm
VETA / Grain VERTICAL	ALTURA <i>Height</i>	ANCHO <i>Width</i>
Máximo <i>Maximum</i>	3000 mm	1197 mm
Mínimo <i>Minimum</i>	130 mm	147 mm
VETA / Grain HORIZONTAL	ALTURA <i>Height</i>	ANCHO <i>Width</i>
Máximo <i>Maximum</i>	1198 mm	1197 mm
Mínimo <i>Minimum</i>	130 mm	147 mm

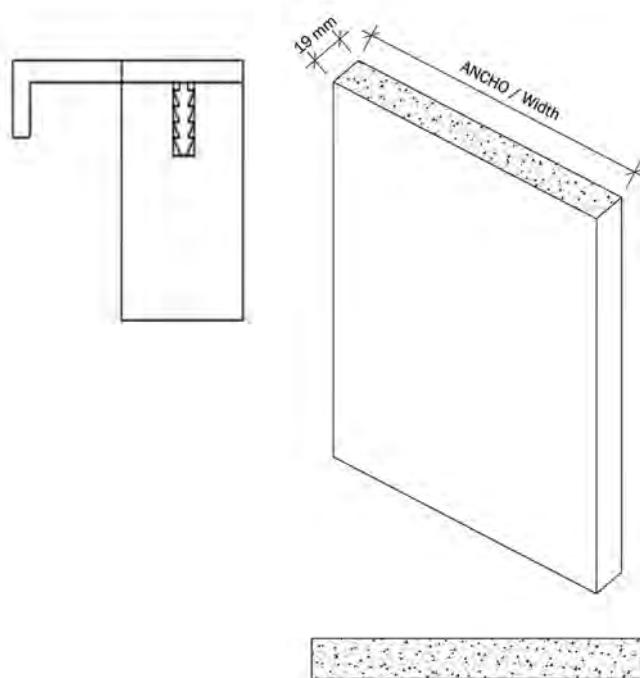

DISEÑOS MODELO RIN 19 mm

Rin 19 mm model designs



Blanco
3091 BRILLO



Blanco Islandia
3091 SEF



Pistacho
COV-222 BRILLO



Burdeos
GLB-247 BRILLO



Crema Suave
GLC-158 BRILLO



Gris
GLG-400 BRILLO



Aluminio
GLI-159 BRILLO



Berenjena
GLK-401 BRILLO



Negro
GLP-283 BRILLO



Rojo escarlata
GLR-244 BRILLO



Café
GLS-248 BRILLO



Cacao maní
INA-814 NDF

PUERTAS, COSTADOS Y REGLETAS / Doors, cover panels and fillers

DISEÑOS MODELO RIN 19 mm*Rin 19 mm model designs*

Blanco Groenlandia
INB-812 NDF



Calacatta
INC-818 NDF



Marquina gris
INM-817 NDF



Negro profundo
INN-816 NDF



Café mokachino
INP-813 NDF



Grafito
INT-815 NDF



Talco
LAR-770 SOFT



Mármol marquina
MAC-820 STUCCO



Mármol emperador
MAY-819 STUCCO



Gris metálico
MTG-765 BRILLO



Óxido azul
OXA-445 WAX



Óxido marrón
OXM-444 WAX

DISEÑOS MODELO RIN 19 mm

Rin 19 mm model designs



**Pino kenia
PIR-022 SOFT**



**Pino viejo
PIV-023 SOFT**



**Roble natural
RON-803 OP**



**Cemento
TRC-443 WAX**

MODELO DUERO 19 mm

Duero 19 mm model

■ CARACTERÍSTICAS TÉCNICAS:

Terminación: canto superior acanalado con tirador integrado en aluminio modelo "LISBOA" y cantos rectos en ABS de igual color a la puerta.

Acabado tirador integrado: inox look.

Soporte: tablero aglomerado.

Recubrimiento: laminado decorativo HPL de 0,7 mm espesor acabado en brillo y film protector. Diseños en madera con veta vertical.

Contracara laminado Idem.

Adhesivo: cola PUR (poliuretano reactivo prensado en frio).

Adhesivo tirador: Express (cola de base acuosa).

Espesor: 19 mm.

■ FEATURES:

Finish: ribbed upper edge with integrated aluminum handle "LISBOA" model and straight edges in ABS of equal color to the door.

Integrated handle finish: stainless look.

Core: particle board.

Covering: 0,7 mm thick decorative HPL laminate shiny finish and protective film. Wood designs with vertical grain.

Backside laminate Idem.

Adhesive: PUR glue (old press reactive polyurethane).

Handle adhesive: Express (water based glue).

Thickness: 19 mm.



MEDIDAS DE PUERTAS Doors measures		
UNICOLORES <i>Unicolors</i>	ALTURA <i>Height</i>	ANCHO <i>Width</i>
Máximo <i>Maximum</i>	3000 mm	1197 mm
Mínimo <i>Minimum</i>	130 mm	147 mm
VETA / Grain VERTICAL	ALTURA <i>Height</i>	ANCHO <i>Width</i>
Máximo <i>Maximum</i>	3000 mm	1197 mm
Mínimo <i>Minimum</i>	130 mm	147 mm
VETA / Grain HORIZONTAL	ALTURA <i>Height</i>	ANCHO <i>Width</i>
Máximo <i>Maximum</i>	1198 mm	1197 mm
Mínimo <i>Minimum</i>	130 mm	147 mm

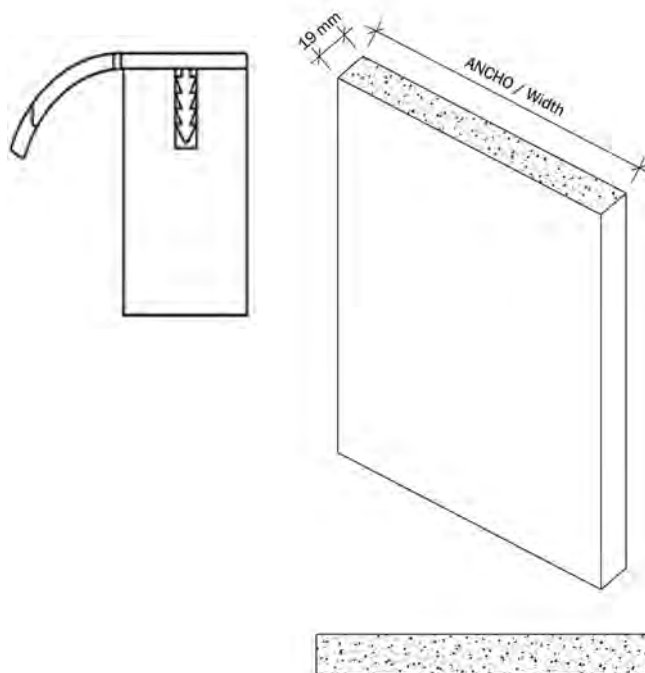

DISEÑOS MODELO DUERO 19 mm

Duero 19 mm model designs



**Blanco
3091 BRILLO**



**Blanco Islandia
3091 SEF**



**Pistacho
COV-222 BRILLO**



**Pistacho
COV-222 BRILLO**



**Crema Suave
GLC-158 BRILLO**



**Gris
GLG-400 BRILLO**



**Aluminio
GLI-159 BRILLO**



**Berenjena
GLK-401 BRILLO**



**Negro
GLP-283 BRILLO**



**Negro
GLP-283 BRILLO**



**Café
GLS-248 BRILLO**



**Cacao maní
INA-814 NDF**

PUERTAS, COSTADOS Y REGLETAS / Doors, cover panels and fillers

DISEÑOS MODELO DUERO 19 mm

Duero 19 mm model designs



Blanco Groenlandia
INB-812 NDF



Calacatta
INC-818 NDF



Marquina gris
INM-817 NDF



Negro profundo
INN-816 NDF



Café mokachino
INP-813 NDF



Grafito
INT-815 NDF



Talco
LAR-770 SOFT



Mármol marquina
MAC-820 STUCCO



Mármol emperador
MAY-819 STUCCO



Gris metálico
MTG-765 BRILLO



Óxido azul
OXA-445 WAX



Óxido marrón
OXM-444 WAX

DISEÑOS MODELO DUERO 19 mm

Duero 19 mm model designs



**Pino kenia
PIR-022 SOFT**



**Pino viejo
PIV-023 SOFT**



**Roble natural
RON-803 OP**



**Cemento
TRC-443 WAX**

MODELO SAONA 19 mm

Saona 19 mm model

■ CARACTERÍSTICAS TÉCNICAS:

Terminación: canto superior acanalado con tirador integrado 45° en aluminio modelo "SAONA" y cantos rectos en ABS de igual color a la puerta.

Acabado tirador integrado: inox look.

Soporte: tablero aglomerado.

Recubrimiento: laminado decorativo HPL de 0,7 mm espesor acabado en brillo y film protector. Diseños en madera con veta vertical.

Contracara laminado Idem.

Adhesivo: cola PUR (poliuretano reactivo prensado en frio).

Adhesivo tirador: Express (cola de base acuosa).

Espesor: 19 mm.

■ FEATURES:

Finish: 45° ribbed upper edge with integrated aluminum handle "SAONA" model and straight edges in ABS of equal color to the door.

Integrated handle finish: stainless look.

Core: particle board.

Covering: 0,7 mm thick decorative HPL laminate shiny finish and protective film. Wood designs with vertical grain.

Backside laminate Idem.

Adhesive: PUR glue (old press reactive polyurethane).

Handle adhesive: Express (water based glue).

Thickness: 19 mm.



MEDIDAS DE PUERTAS Doors measures		
UNICOLORES <i>Unicolors</i>	ALTURA <i>Height</i>	ANCHO <i>Width</i>
Máximo <i>Maximum</i>	3000 mm	1197 mm
Mínimo <i>Minimum</i>	130 mm	147 mm
VETA / Grain VERTICAL	ALTURA <i>Height</i>	ANCHO <i>Width</i>
Máximo <i>Maximum</i>	3000 mm	1197 mm
Mínimo <i>Minimum</i>	130 mm	147 mm
VETA / Grain HORIZONTAL	ALTURA <i>Height</i>	ANCHO <i>Width</i>
Máximo <i>Maximum</i>	1498 mm	1197 mm
Mínimo <i>Minimum</i>	130 mm	147 mm

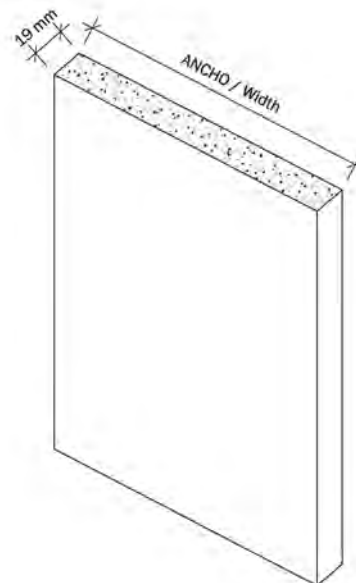

DISEÑOS MODELO SAONA 19 mm

Saona 19 mm model designs

PUERTAS, COSTADOS Y REGLETAS / Doors, cover panels and fillers



Blanco
3091 BRILLO



Blanco Islandia
3091 SEF



Pistacho
COV-222 BRILLO



Burdeos
GLB-247 BRILLO



Crema Suave
GLC-158 BRILLO



Gris
GLG-400 BRILLO



Aluminio
GLI-159 BRILLO



Berenjena
GLK-401 BRILLO



Negro
GLP-283 BRILLO



Rojo escarlata
GLR-244 BRILLO



Café
GLS-248 BRILLO



Cacao maní
INA-814 NDF

DISEÑOS MODELO SAONA 19 mm

Saona 19 mm model designs



Blanco Groenlandia
INB-812 NDF



Calacatta
INC-818 NDF



Marquina gris
INM-817 NDF



Negro profundo
INN-816 NDF



Café mokachino
INP-813 NDF



Grafito
INT-815 NDF



Talco
LAR-770 SOFT



Mármol marquina
MAC-820 STUCCO



Mármol emperador
MAY-819 STUCCO



Gris metálico
MTG-765 BRILLO



Óxido azul
OXA-445 WAX



Óxido marrón
OXM-444 WAX

DISEÑOS MODELO SAONA 19 mm

Saona 19 mm model designs



**Pino kenia
PIR-022 SOFT**



**Pino viejo
PIV-023 SOFT**



**Roble natural
RON-803 OP**



**Cemento
TRC-443 WAX**

C.



TOP FORM

MODELO ELBA 19 mm

Elba 19 mm model

■ CARACTERÍSTICAS TÉCNICAS:

Terminación: cuatro cantos en ABS de igual color del frente.

Soporte: tablero aglomerado.

Recubrimiento: capa melamínica interna prensada, más laminado decorativo sintético PET/TSL externo acabado en súper brillo o súper mate (SP) y film protector. Diseños en madera con veta vertical.

Contracara: simil.

Adhesivo: cola PUR (poliuretano reactivo prensado en frío).

Espesor: 19 mm.

■ FEATURES:

Finish: four edges in ABS of the same front color.

Core: particle board.

Covering: internal melaminica cape press plus synthetic decorative laminate

PET/TSL finish super-shiny or super-matte (SP) and protective film.

Wood designs with vertical grain.

Backside: similar

Adhesive: PUR glue (old press reactive polyurethane).

Thickness: 19 mm.



MEDIDAS DE PUERTAS Doors measures		
UNICOLORES <i>Unicolors</i>	ALTURA <i>Height</i>	ANCHO <i>Width</i>
Máximo <i>Maximum</i>	2800 mm	1197 mm
Mínimo <i>Minimum</i>	100 mm	100 mm
VETA / Grain VERTICAL	ALTURA <i>Height</i>	ANCHO <i>Width</i>
Máximo <i>Maximum</i>	2800 mm	1197 mm
Mínimo <i>Minimum</i>	100 mm	100 mm
VETA / Grain HORIZONTAL	ALTURA <i>Height</i>	ANCHO <i>Width</i>
Máximo <i>Maximum</i>	1498 mm	1197 mm
Mínimo <i>Minimum</i>	100 mm	100 mm

Nota: diseños acabado en brillo marcados con asterisco (*) disponible con terminación en cuatro cantos **VIDRIO**.

Note: super-shiny finish designs marked with an asterisk (*) available termination with four-edge **GLASS** finish.

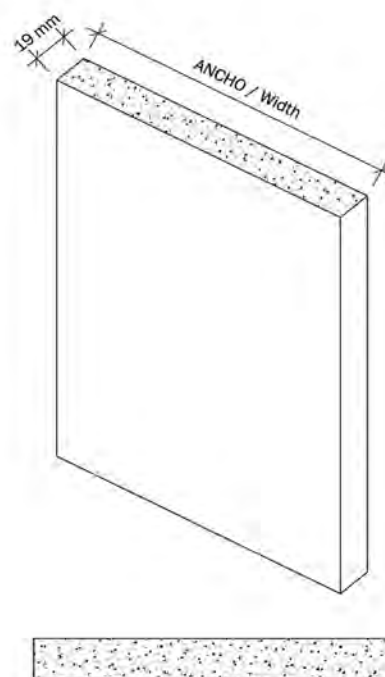

DISEÑOS MODELO ELBA 19 mm

Elba 19 mm model designs



**Blanco Finlandia
PEB-070 BRILLO ***



**Crema
PEB-071 BRILLO ***



**Lava
PEB-072 BRILLO ***



**Gris oscuro
PEB-073 BRILLO ***



**Rojo cherry
PEB-077 BRILLO ***



**Negro madagascar
PEB-078 BRILLO ***



**Café Latte
PEB-080 BRILLO ***



**Ceniza
PEB-081 BRILLO ***



**Burdeos teja.
PEB-085 BRILLO ***



**Aguamarina urban.
PEB-086 BRILLO ***



**Roble claro.
OAC-809 BRILLO ***



**Roble elegancia.
OAD-822 BRILLO ***

PUERTAS, COSTADOS Y REGLETAS / Doors, cover panels and fillers

DISEÑOS MODELO ELBA 19 mm

Elba 19 mm model designs



Roble avellana
OAM-806 BRILLO *



Roble aneto
OAN-807 BRILLO *



Roble tostado
OAT-808 BRILLO *



Aguamarina urban
PEM-051 SP



Burdeos teja
PEM-052 SP



Cacao
PEM-055 SP



Ceniza
PEM-056 SP



Gris oscuro
PEM-057 SP



Café Latte
PEM-058 SP



Blanco Finlandia
PEM-060 SP



Capuchino
PEM-061 SP



Rojo cherry
PEM-063 SP

DISEÑOS MODELO ELBA 19 mm

Elba 19 mm model designs



**Negro madagascar
PEM-064 SP**



**Roble claro
OAC-809 SP**



**Roble elegace
OAD-822 SP**



**Roble avellana
OAM-806 SP**



**Roble aneto
OAN-807 SP**



**Roble tostado
OAT-808 SP**

MODELO TÁMESIS 19 mm

Tamesis 19 mm model

■ CARACTERÍSTICAS TÉCNICAS:

Terminación: canto superior con perfil tirador postformado tipo "J" y cantos rectos en ABS de igual color del frente.

Soporte: tablero aglomerado.

Recubrimiento: capa melamínica interna prensada, más laminado decorativo sintético PET/TSL externo acabado en súper mate (SP) y film protector.

Diseños en madera con veta horizontal.

Contracara: simil.

Adhesivo: cola PUR (poliuretano reactivo prensado en frio).

Espesor: 19 mm.

■ FEATURES:

Finish: top edge with postforming profile handle type "J" and straight edges in ABS of the same front color.

Core: particle board.

Covering: internal melaminica cape press plus synthetic decorative laminate PET/TSL finish super-matte (SP) and protective film.

Wood designs with horizontal grain.

Backside: similar

Adhesive: PUR glue (old press reactive polyurethane).

Thickness: 19 mm.



MEDIDAS DE PUERTAS Doors measures		
UNICOLORS <i>Unicolors</i>	ALTURA <i>Height</i>	ANCHO <i>Width</i>
Máximo <i>Maximum</i>	1298 mm	2800 mm
Mínimo <i>Minimum</i>	138 mm	100 mm
VETA / Grain HORIZONTAL	ALTURA <i>Height</i>	ANCHO <i>Width</i>
Máximo <i>Maximum</i>	1298 mm	1298 mm
Mínimo <i>Minimum</i>	138 mm	100 mm
VETA / Grain VERTICAL	ALTURA <i>Height</i>	ANCHO <i>Width</i>
Máximo <i>Maximum</i>	1298 mm	1298 mm
Mínimo <i>Minimum</i>	138 mm	100 mm

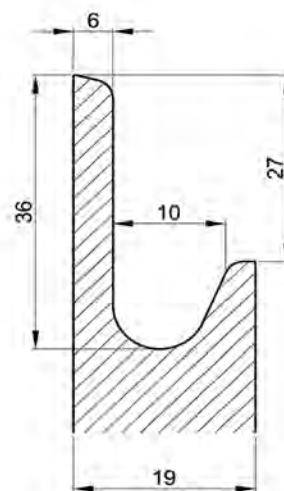

Nota: UNICOLORS en diseños PEM-051 SP y PEM-052 SP, altura máxima de puerta 1185 mm.

Note: UNICOLORS in designs PEM-051 SP and PEM-052 SP, height door maximum 1185 mm.

DISEÑOS MODELO TÁMESIS 19 mm

Tamesis 19 mm model designs

PUERTAS, COSTADOS Y REGLETAS / Doors, cover panels and fillers



Aguamarina urban
PEM-051 SP



Burdeos teja
PEM-052 SP



Cacao
PEM-055 SP



Ceniza
PEM-056 SP



Gris oscuro
PEM-057 SP



Café Latte
PEM-058 SP



Blanco Finlandia
PEM-060 SP



Capuchino
PEM-061 SP



Rojo cherry
PEM-063 SP



Negro madagascar
PEM-064 SP



Roble claro
OAC-809 SP



Roble elegance
OAD-822 SP

DISEÑOS MODELO TÁMESIS 19 mm*Tamesis 19 mm model designs*

**Roble avellana
OAM-806 SP**



**Roble aneto
OAN-807 SP**



**Roble tostado
OAT-808 SP**

MODELO ONEGA 19 mm

Onega 19 mm model

■ CARACTERÍSTICAS TÉCNICAS:

Terminación: canto superior con perfil tirador postformado tipo "U" y cantos rectos en ABS de igual color del frente.

Soporte: tablero aglomerado.

Recubrimiento: capa melaminica interna prensada, más laminado decorativo sintético PET/TSL externo acabado en súper mate (SP) y film protector.

Diseños en madera con veta horizontal.

Contracara: simil.

Adhesivo: cola PUR (poliuretano reactivo prensado en frio).

Espesor: 19 mm.

■ FEATURES:

Finish: top edge with postforming profile handle type "U" and straight edges in ABS of the same front color.

Core: particle board.

Covering: internal melaminica cape press plus synthetic decorative laminate PET/TSL finish super-matte (SP) and protective film.

Wood designs with horizontal grain.

Backside: similar

Adhesive: PUR glue (old press reactive polyurethane).

Thickness: 19 mm.



MEDIDAS DE PUERTAS Doors measures		
UNICOLORES <i>Unicolors</i>	ALTURA <i>Height</i>	ANCHO <i>Width</i>
Máximo <i>Maximum</i>	1298 mm	2800 mm
Mínimo <i>Minimum</i>	138 mm	100 mm
VETA / Grain HORIZONTAL	ALTURA <i>Height</i>	ANCHO <i>Width</i>
Máximo <i>Maximum</i>	1298 mm	1298 mm
Mínimo <i>Minimum</i>	138 mm	100 mm
VETA / Grain VERTICAL	ALTURA <i>Height</i>	ANCHO <i>Width</i>
Máximo <i>Maximum</i>	1298 mm	1298 mm
Mínimo <i>Minimum</i>	138 mm	100 mm

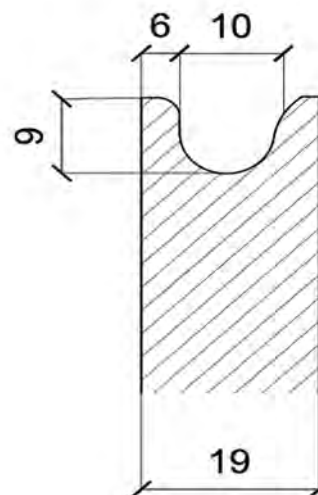

Nota: UNICOLORES en diseños PEM-051 SP y PEM-052 SP, altura máxima de puerta 1185 mm.

Note: UNICOLORS in designs PEM-051 SP and PEM-052 SP, height door maximum 1185 mm.

DISEÑOS MODELO ONEGA 19 mm*Onega 19 mm model designs*

Aguamarina urban
PEM-051 SP



Burdeos teja
PEM-052 SP



Cacao
PEM-055 SP



Ceniza
PEM-056 SP



Gris oscuro
PEM-057 SP



Café Latte
PEM-058 SP



Blanco Finlandia
PEM-060 SP



Capuchino
PEM-061 SP



Rojo cherry
PEM-063 SP



Negro madagascar
PEM-064 SP



Roble claro
OAC-809 SP



Roble elegancia
OAD-822 SP

DISEÑOS MODELO ONEGA 19 mm

Onega 19 mm model designs



**Roble avellana
OAM-806 SP**



**Roble aneto
OAN-807 SP**



**Roble tostado
OAT-808 SP**

MODELO SENA 19 mm

Sena 19 mm model

■ CARACTERÍSTICAS TÉCNICAS:

Terminación: canto superior acanalado con tirador integrado en aluminio modelo "ALTAMIRA" y cantos rectos en ABS de igual color a la puerta.

Acabado tirador integrado: plata mate, inox y blanco.

Soporte: tablero aglomerado.

Recubrimiento: capa melamínica interna prensada, más laminado decorativo sintético PET/TSL externo acabado en súper brillo o súper mate (SP) y film protector. Diseños en madera con veta vertical.

Contracara: simil.

Adhesivo: cola PUR (poliuretano reactivo prensado en frio).

Adhesivo tirador: Express (cola de base acuosa).

Espesor: 19 mm.

■ FEATURES:

Finish: ribbed upper edge with integrated aluminum handle "ALTAMIRA" model and straight edges in ABS of equal color to the door.

Integrated handle finish: matt silver, stainless steel and white.

Core: particle board.

Covering: internal melaminica cape press plus synthetic decorative laminate PET/TSL finish super-shiny or super-matte (SP) and protective film.

Wood designs with vertical grain.

Backside: similar

Adhesive: PUR glue (old press reactive polyurethane).

Handle adhesive: Express (water based glue).

Thickness: 19 mm.

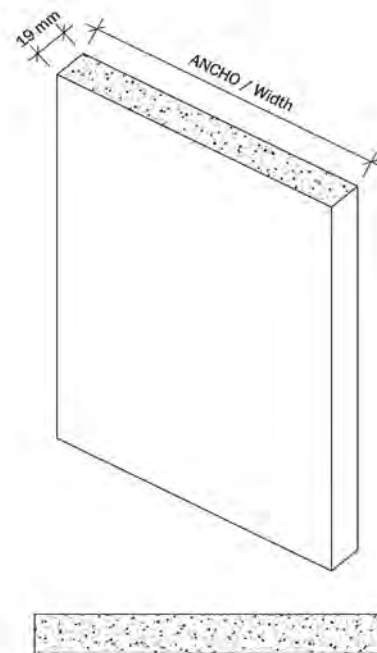

MEDIDAS DE PUERTAS Doors measures		
UNICOLORES <i>Unicolors</i>	ALTURA <i>Height</i>	ANCHO <i>Width</i>
Máximo <i>Maximum</i>	2800 mm	1197 mm
Mínimo <i>Minimum</i>	130 mm	147 mm
VETA / Grain VERTICAL	ALTURA <i>Height</i>	ANCHO <i>Width</i>
Máximo <i>Maximum</i>	2800 mm	1197 mm
Mínimo <i>Minimum</i>	130 mm	147 mm
VETA / Grain HORIZONTAL	ALTURA <i>Height</i>	ANCHO <i>Width</i>
Máximo <i>Maximum</i>	1498 mm	1197 mm
Mínimo <i>Minimum</i>	130 mm	147 mm

Nota: diseños acabados en brillo marcados con asterisco (*) disponible con terminación en cuatro cantos **VIDRIO**.

Note: super-shiny finish designs marked with an asterisk (*) available termination with four-edge **GLASS** finish.

DISEÑOS MODELO SENA 19 mm

Sena 19 mm model designs



**Blanco Finlandia
PEB-070 BRILLO ***



**Crema
PEB-071 BRILLO ***



**Lava
PEB-072 BRILLO ***



**Gris oscuro
PEB-073 BRILLO ***



**Rojo cherry
PEB-077 BRILLO ***



**Negro madagascar
PEB-078 BRILLO ***



**Café Latte
PEB-080 BRILLO ***



**Ceniza
PEB-081 BRILLO ***



**Burdeos teja
PEB-085 BRILLO ***



**Aguamarina urban
PEB-086 BRILLO ***



**Roble claro
OAC-809 BRILLO ***



**Roble elegance
OAD-822 BRILLO ***

PUERTAS, COSTADOS Y REGLETAS / Doors, cover panels and fillers

DISEÑOS MODELO SENA 19 mm*Sena 19 mm model designs*

Roble avellana
OAM-806 BRILLO *



Roble aneto
OAN-807 BRILLO *



Roble tostado
OAT-808 BRILLO *



Aguamarina urban
PEM-051 SP



Burdeos teja
PEM-052 SP



Cacao
PEM-055 SP



Ceniza
PEM-056 SP



Gris oscuro
PEM-057 SP



Café Latte
PEM-058 SP



Blanco Finlandia
PEM-060 SP



Capuchino
PEM-061 SP



Rojo cherry
PEM-063 SP

DISEÑOS MODELO SENA 19 mm

Sena 19 mm model designs



**Negro madagascar
PEM-064 SP**



**Roble claro
OAC-809 SP**



**Roble elegace
OAD-822 SP**



**Roble avellana
OAM-806 SP**



**Roble aneto
OAN-807 SP**



**Roble tostado
OAT-808 SP**

MODELO TÍBER 19 mm

Tiber 19 mm model

■ CARACTERÍSTICAS TÉCNICAS:

Terminación: canto superior acanalado con tirador integrado en aluminio modelo "VENECIA" y cantos rectos en ABS de igual color a la puerta.

Acabado tirador integrado: plata mate, inox y blanco.

Soporte: tablero aglomerado.

Recubrimiento: capa melamínica interna prensada, más laminado decorativo sintético PET/TSL externo acabado en súper brillo o súper mate (SP) y film protector. Diseños en madera con veta vertical.

Contracara: simil.

Adhesivo: cola PUR (poliuretano reactivo prensado en frio).

Adhesivo tirador: Express (cola de base acuosa).

Espesor: 19 mm.

■ FEATURES:

Finish: ribbed upper edge with integrated aluminum handle "VENECIA" model and straight edges in ABS of equal color to the door.

Integrated handle finish: matt silver, stainless steel and white.

Core: particle board.

Covering: internal melaminica cape press plus synthetic decorative laminate PET/TSL finish super-shiny or super-matte (SP) and protective film.

Wood designs with vertical grain.

Backside: similar

Adhesive: PUR glue (old press reactive polyurethane).

Handle adhesive: Express (water based glue).

Thickness: 19 mm.

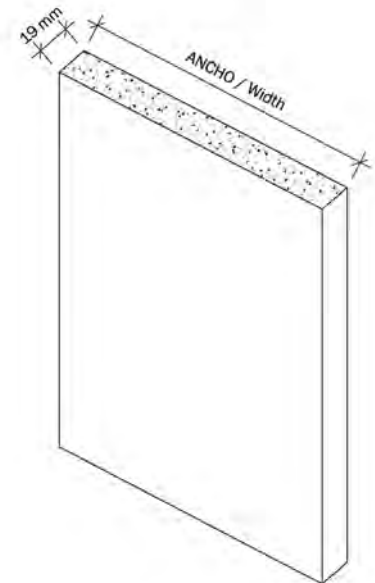
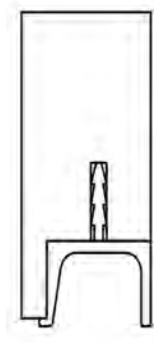

MEDIDAS DE PUERTAS Doors measures		
UNICOLORES <i>Unicolors</i>	ALTURA <i>Height</i>	ANCHO <i>Width</i>
Máximo <i>Maximum</i>	2800 mm	1197 mm
Mínimo <i>Minimum</i>	130 mm	147 mm
VETA / Grain VERTICAL	ALTURA <i>Height</i>	ANCHO <i>Width</i>
Máximo <i>Maximum</i>	2800 mm	1197 mm
Mínimo <i>Minimum</i>	130 mm	147 mm
VETA / Grain HORIZONTAL	ALTURA <i>Height</i>	ANCHO <i>Width</i>
Máximo <i>Maximum</i>	1498 mm	1197 mm
Mínimo <i>Minimum</i>	130 mm	147 mm

Nota: diseños acabados en brillo marcados con asterisco (*) disponible con terminación en cuatro cantos **VIDRIO**.

Note: super-shiny finish designs marked with an asterisk (*) available termination with four-edge **GLASS** finish.

DISEÑOS MODELO TÍBER 19 mm

Tiber 19 mm model designs



**Blanco Finlandia
PEB-070 BRILLO ***



**Crema
PEB-071 BRILLO ***



**Lava
PEB-072 BRILLO ***



**Gris oscuro
PEB-073 BRILLO ***



**Rojo cherry
PEB-077 BRILLO ***



**Negro madagascar
PEB-078 BRILLO ***



**Café Latte
PEB-080 BRILLO ***



**Ceniza
PEB-081 BRILLO ***



**Burdeos teja
PEB-085 BRILLO ***



**Aguamarina urban
PEB-086 BRILLO ***



**Roble claro
OAC-809 BRILLO ***



**Roble elegance
OAD-822 BRILLO ***

PUERTAS, COSTADOS Y REGLETAS / Doors, cover panels and fillers

DISEÑOS MODELO TÍBER 19 mm

Tiber 19 mm model designs



Roble avellana
OAM-806 BRILLO *



Roble aneto
OAN-807 BRILLO *



Roble tostado
OAT-808 BRILLO *



Aguamarina urban
PEM-051 SP



Burdeos teja
PEM-052 SP



Cacao
PEM-055 SP



Ceniza
PEM-056 SP



Gris oscuro
PEM-057 SP



Café Latte
PEM-058 SP



Blanco Finlandia
PEM-060 SP



Blanco Finlandia
PEM-060 SP



Rojo cherry
PEM-063 SP

DISEÑOS MODELO TÍBER 19 mm

Tiber 19 mm model designs



**Negro madagascar.
PEM-064 SP**



**Roble claro.
OAC-809 SP**



**Roble elegancia.
OAD-822 SP**



**Roble avellana.
OAM-806 SP**



**Roble aneto.
OAN-807 SP**



**Roble tostado.
OAT-808 SP**

MODELO RIN 19 mm

Rin 19 mm model

■ CARACTERÍSTICAS TÉCNICAS:

Terminación: canto superior acanalado con tirador integrado en aluminio modelo "BRUJAS" y cantos rectos en ABS de igual color a la puerta.

Acabado tirador integrado: plata mate, inox y blanco.

Soporte: tablero aglomerado.

Recubrimiento: capa melaminica interna prensada, más laminado decorativo sintético PET/TSL externo acabado en súper brillo o súper mate (SP) y film protector. Diseños en madera con veta vertical.

Contracara: simil.

Adhesivo: cola PUR (poliuretano reactivo prensado en frio).

Adhesivo tirador: Express (cola de base acuosa).

Espesor: 19 mm.

■ FEATURES:

Finish: ribbed upper edge with integrated aluminum handle "BRUJAS" model and straight edges in ABS of equal color to the door.

Integrated handle finish: matt silver, stainless steel and white.

Core: particle board.

Covering: internal melaminica cape press plus synthetic decorative laminate PET/TSL finish super-shiny or super-matte (SP) and protective film.

Wood designs with vertical grain.

Backside: similar

Adhesive: PUR glue (old press reactive polyurethane).

Handle adhesive: Express (water based glue).

Thickness: 19 mm.

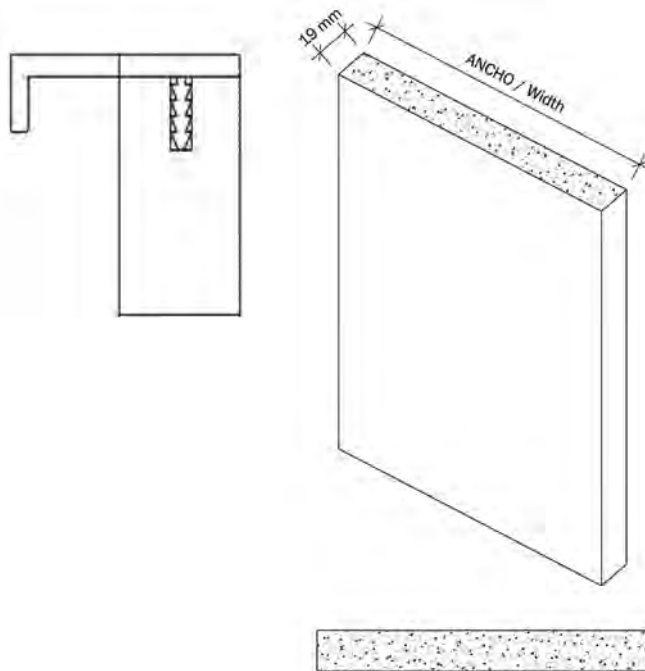

MEDIDAS DE PUERTAS Doors measures		
UNICOLORES <i>Unicolors</i>	ALTURA <i>Height</i>	ANCHO <i>Width</i>
Máximo <i>Maximum</i>	2800 mm	1197 mm
Mínimo <i>Minimum</i>	130 mm	147 mm
VETA / Grain VERTICAL	ALTURA <i>Height</i>	ANCHO <i>Width</i>
Máximo <i>Maximum</i>	2800 mm	1197 mm
Mínimo <i>Minimum</i>	130 mm	147 mm
VETA / Grain HORIZONTAL	ALTURA <i>Height</i>	ANCHO <i>Width</i>
Máximo <i>Maximum</i>	1198 mm	1197 mm
Mínimo <i>Minimum</i>	130 mm	147 mm

Nota: diseños acabados en brillo marcados con asterisco (*) disponible con terminación en cuatro cantos **VIDRIO**.

Note: super-shiny finish designs marked with an asterisk (*) available termination with four-edge **GLASS** finish.

DISEÑOS MODELO RIN 19 mm

Rin 19 mm model designs

PUERTAS, COSTADOS Y REGLETAS / Doors, cover panels and fillers



**Blanco Finlandia
PEB-070 BRILLO ***



**Crema
PEB-071 BRILLO ***



**Lava
PEB-072 BRILLO ***



**Gris oscuro
PEB-073 BRILLO ***



**Rojo cherry
PEB-077 BRILLO ***



**Negro madagascar
PEB-078 BRILLO ***



**Café Latte
PEB-080 BRILLO ***



**Ceniza
PEB-081 BRILLO ***



**Burdeos teja
PEB-085 BRILLO ***



**Aguamarina urban
PEB-086 BRILLO ***



**Roble claro
OAC-809 BRILLO ***



**Roble elegance
OAD-822 BRILLO ***

DISEÑOS MODELO RIN 19 mm

Rin 19 mm model designs



Roble avellana
OAM-806 BRILLO *



Roble aneto
OAN-807 BRILLO *



Roble tostado
OAT-808 BRILLO *



Aguamarina urban
PEM-051 SP



Burdeos teja
PEM-052 SP



Burdeos teja
PEM-052 SP



Ceniza
PEM-056 SP



Gris oscuro
PEM-057 SP



Café Latte
PEM-058 SP



Blanco Finlandia
PEM-060 SP



Capuchino
PEM-061 SP



Rojo cherry
PEM-063 SP

DISEÑOS MODELO RIN 19 mm

Rin 19 mm model designs



Negro madagascar
PEM-064 SP



Roble claro
OAC-809 SP



Roble elegace
OAD-822 SP



Roble avellana
OAM-806 SP



Roble aneto
OAN-807 SP



Roble tostado
OAT-808 SP

MODELO DUERO 19 mm

Duero 19 mm model

■ CARACTERÍSTICAS TÉCNICAS:

Terminación: canto superior acanalado con tirador integrado en aluminio modelo "LISBOA" y cantos rectos en ABS de igual color a la puerta.

Acabado tirador integrado: plata mate, inox y blanco.

Soporte: tablero aglomerado.

Recubrimiento: capa melaminica interna prensada, más laminado decorativo sintético PET/TSL externo acabado en súper brillo o súper mate (SP) y film protector. Diseños en madera con veta vertical.

Contracara: simil.

Adhesivo: cola PUR (poliuretano reactivo prensado en frio).

Adhesivo tirador: Express (cola de base acuosa).

Espesor: 19 mm.

■ FEATURES:

Finish: ribbed upper edge with integrated aluminum handle "LISBOA" model and straight edges in ABS of equal color to the door.

Integrated handle finish: matt silver, stainless steel and white.

Core: particle board.

Covering: internal melaminica cape press plus synthetic decorative laminate

PET/TSL finish super-shiny or super-matte (SP) and protective film.

Wood designs with vertical grain.

Backside: similar

Adhesive: PUR glue (old press reactive polyurethane).

Handle adhesive: Express (water based glue).

Thickness: 19 mm.

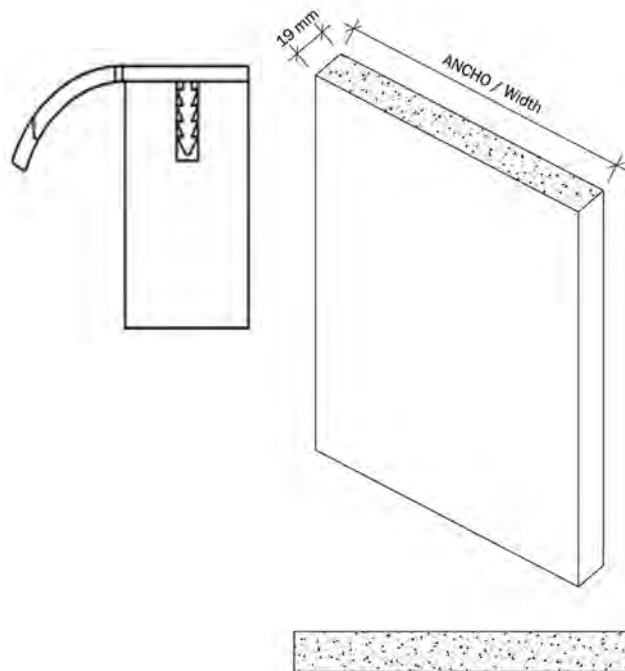

MEDIDAS DE PUERTAS Doors measures		
UNICOLORES <i>Unicolors</i>	ALTURA <i>Height</i>	ANCHO <i>Width</i>
Máximo <i>Maximum</i>	2800 mm	1197 mm
Mínimo <i>Minimum</i>	130 mm	147 mm
VETA / Grain VERTICAL	ALTURA <i>Height</i>	ANCHO <i>Width</i>
Máximo <i>Maximum</i>	2800 mm	1197 mm
Mínimo <i>Minimum</i>	130 mm	147 mm
VETA / Grain HORIZONTAL	ALTURA <i>Height</i>	ANCHO <i>Width</i>
Máximo <i>Maximum</i>	1498 mm	1197 mm
Mínimo <i>Minimum</i>	130 mm	147 mm

Nota: diseños acabados en brillo marcados con asterisco (*) disponible con terminación en cuatro cantos **VIDRIO**.

Note: super-shiny finish designs marked with an asterisk (*) available termination with four-edge **GLASS** finish.

DISEÑOS MODELO DUERO 19 mm

Duero 19 mm model designs



**Blanco Finlandia
PEB-070 BRILLO ***



**Crema
PEB-071 BRILLO ***



**Lava
PEB-072 BRILLO ***



**Gris oscuro
PEB-073 BRILLO ***



**Rojo cherry
PEB-077 BRILLO ***



**Negro madagascar
PEB-078 BRILLO ***



**Café Latte
PEB-080 BRILLO ***



**Ceniza
PEB-081 BRILLO ***



**Burdeos teja
PEB-085 BRILLO ***



**Aguamarina urban
PEB-086 BRILLO ***



**Roble claro
OAC-809 BRILLO ***



**Roble elegance
OAD-822 BRILLO ***

PUERTAS, COSTADOS Y REGLETAS / Doors, cover panels and fillers

DISEÑOS MODELO DUERO 19 mm

Duero 19 mm model designs



Roble avellana
OAM-806 BRILLO *



Roble aneto
OAN-807 BRILLO *



Roble tostado
OAT-808 BRILLO *



Aguamarina urban
PEM-051 SP



Burdeos teja
PEM-052 SP



Cacao
PEM-055 SP



Ceniza
PEM-056 SP



Gris oscuro
PEM-057 SP



Café Latte
PEM-058 SP



Blanco Finlandia
PEM-060 SP



Capuchino
PEM-061 SP



Capuchino
PEM-061 SP

DISEÑOS MODELO DUERO 19 mm

Duero 19 mm model designs



**Negro madagascar
PEM-064 SP**



**Roble claro
OAC-809 SP**



**Roble elegace
OAD-822 SP**



**Roble avellana
OAM-806 SP**



**Roble aneto
OAN-807 SP**



**Roble tostado
OAT-808 SP**

MODELO SAONA 19 mm

Saona 19 mm model

■ CARACTERÍSTICAS TÉCNICAS:

Terminación: canto superior acanalado con tirador integrado 45° en aluminio modelo "SAONA" y cantos rectos en ABS de igual color a la puerta.

Acabado tirador integrado: inox look.

Soporte: tablero aglomerado.

Recubrimiento: capa melaminica interna prensada, más laminado decorativo sintético PET/TSL externo acabado en súper brillo o súper mate (SP) y film protector. Diseños en madera con veta vertical.

Contracara: simil.

Adhesivo: cola PUR (poliuretano reactivo prensado en frio).

Adhesivo tirador: Express (cola de base acuosa).

Espesor: 19 mm.

■ FEATURES:

Finish: 45° ribbed upper edge with integrated aluminum handle "SAONA" model and straight edges in ABS of equal color to the door.

Integrated handle finish: stainless look.

Core: particle board.

Covering: internal melaminica cape press plus synthetic decorative laminate PET/TSL finish super-shiny or super-matte (SP) and protective film.

Wood designs with vertical grain.

Backside: similar

Adhesive: PUR glue (old press reactive polyurethane).

Handle adhesive: Express (water based glue).

Thickness: 19 mm.

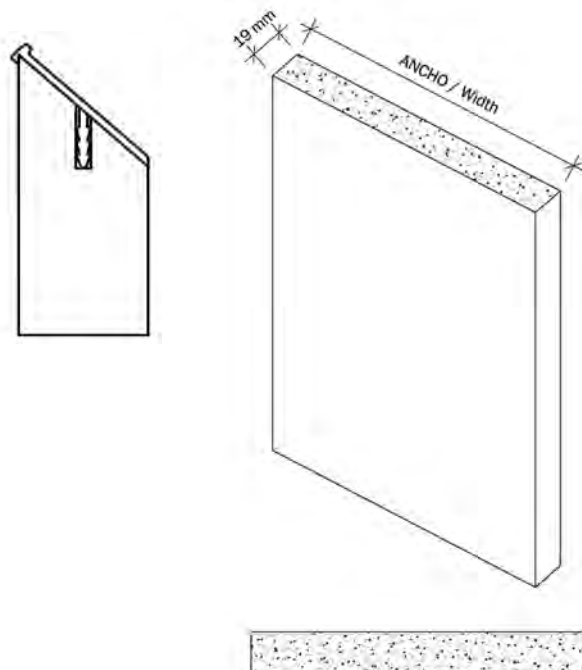

MEDIDAS DE PUERTAS Doors measures		
UNICOLORES <i>Unicolors</i>	ALTURA <i>Height</i>	ANCHO <i>Width</i>
Máximo <i>Maximum</i>	2800 mm	1197 mm
Mínimo <i>Minimum</i>	130 mm	147 mm
VETA / Grain VERTICAL	ALTURA <i>Height</i>	ANCHO <i>Width</i>
Máximo <i>Maximum</i>	2800 mm	1197 mm
Mínimo <i>Minimum</i>	130 mm	147 mm
VETA / Grain HORIZONTAL	ALTURA <i>Height</i>	ANCHO <i>Width</i>
Máximo <i>Maximum</i>	1498 mm	1197 mm
Mínimo <i>Minimum</i>	130 mm	147 mm

Nota: diseños acabados en brillo marcados con asterisco (*) disponible con terminación en cuatro cantos **VIDRIO**.

Note: super-shiny finish designs marked with an asterisk (*) available termination with four-edge **GLASS** finish.

DISEÑOS MODELO SAONA 19 mm

Saona 19 mm model designs

PUERTAS, COSTADOS Y REGLETAS / Doors, cover panels and fillers



**Blanco Finlandia
PEB-070 BRILLO ***



**Blanco Finlandia
PEB-070 BRILLO ***



**Lava
PEB-072 BRILLO ***



**Gris oscuro
PEB-073 BRILLO ***



**Rojo cherry
PEB-077 BRILLO ***



**Negro madagascar
PEB-078 BRILLO ***



**Café Latte
PEB-080 BRILLO ***



**Ceniza
PEB-081 BRILLO ***



**Burdeos teja
PEB-085 BRILLO ***



**Aguamarina urban
PEB-086 BRILLO ***



**Roble claro
OAC-809 BRILLO ***



**Roble elegance
OAD-822 BRILLO ***

DISEÑOS MODELO SAONA 19 mm

Saona 19 mm model designs



Roble avellana
OAM-806 BRILLO *



Roble aneto
OAN-807 BRILLO *



Roble tostado
OAT-808 BRILLO *



Aguamarina urban
PEM-051 SP



Aguamarina urban
PEM-051 SP



Cacao
PEM-055 SP



Ceniza
PEM-056 SP



Gris oscuro
PEM-057 SP



Café Latte
PEM-058 SP



Blanco Finlandia
PEM-060 SP



Capuchino
PEM-061 SP



Rojo cherry
PEM-063 SP

DISEÑOS MODELO SAONA 19 mm

Saona 19 mm model designs



Negro madagascar
PEM-064 SP



Roble claro
OAC-809 SP



Roble elegace
OAD-822 SP



Roble avellana
OAM-806 SP



Roble aneto
OAN-807 SP



Roble tostado
OAT-808 SP

D.

premium pet

PUERTAS, COSTADOS Y REGLETAS / Doors, cover panels and fillers



TOP FORM

MODELO ELBA 22 mm

Elba 22 mm model

■ CARACTERÍSTICAS TÉCNICAS:

Terminación: cuatro cantos en ABS de igual color del frente.

Soporte: tablero MDF.

Recubrimiento: capa melaminica interna prensada, más laminado decorativo sintético PET externo acabado en súper brillo, súper mate (SP) y texturados con film protector.

Diseños en madera con veta vertical.

Contracara: símil.

Adhesivo: cola PUR (poliuretano reactivo prensado en frio).

Espesor: 22 mm.

■ FEATURES:*Finish: four edges in ABS of the same front color.**Core: MDF board.**Covering: internal melaminica cape press plus synthetic decorative laminate PET finish super-shiny, super-matte (SP) and textured with protective film.**Wood designs with vertical grain.**Backside: similar**Adhesive: PUR glue (old press reactive polyurethane).**Thickness: 22 mm.*

MEDIDAS DE PUERTAS Doors measures		
UNICOLORES <i>Unicolors</i>	ALTURA <i>Height</i>	ANCHO <i>Width</i>
Máximo <i>Maximum</i>	2800 mm	1197 mm
Mínimo <i>Minimum</i>	100 mm	100 mm
VETA / Grain VERTICAL	ALTURA <i>Height</i>	ANCHO <i>Width</i>
Máximo <i>Maximum</i>	2800 mm	1197 mm
Mínimo <i>Minimum</i>	100 mm	100 mm
VETA / Grain HORIZONTAL	ALTURA <i>Height</i>	ANCHO <i>Width</i>
Máximo <i>Maximum</i>	1298 mm	1197 mm
Mínimo <i>Minimum</i>	100 mm	100 mm

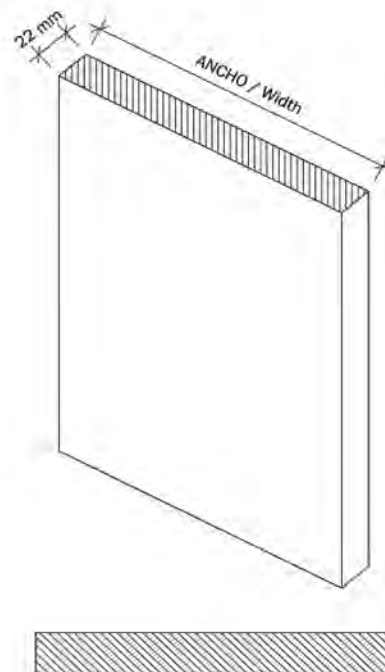

DISEÑOS MODELO ELBA 22 mm

Elba 22 mm model designs



**Blanco Finlandia
PEB-070 BRILLO**



**Crema
PEB-071 BRILLO**



**Lava
PEB-072 BRILLO**



**Gris oscuro
PEB-073 BRILLO**



**Rojo cherry
PEB-077 BRILLO**



**Negro madagascar
PEB-078 BRILLO**



**Café Latte
PEB-080 BRILLO**



**Ceniza
PEB-081 BRILLO**



**Burdeos teja
PEB-085 BRILLO**



**Aguamarina urban
PEB-086 BRILLO**



**Blanco Suecia
PER-001 GRAIN**



**Blanco Suecia
PER-001 GRAIN**

PUERTAS, COSTADOS Y REGLETAS / Doors, cover panels and fillers

DISEÑOS MODELO ELBA 22 mm

Elba 22 mm model designs



Gris Londres
PER-003 GRAIN



Bronce
PEW-100 METALLIC



Aguamarina urban
PEM-051 SP



Burdeos teja
PEM-052 SP



Cacao
PEM-055 SP



Ceniza
PEM-056 SP



Gris oscuro
PEM-057 SP



Café Latte
PEM-058 SP



Blanco Finlandia
PEM-060 SP



Capuchino
PEM-061 SP



Rojo cherry
PEM-063 SP



Negro madagascar
PEM-064 SP

MODELO TAMESIS 22 mm

Tamesis 22 mm model

■ CARACTERÍSTICAS TÉCNICAS:

Terminación: canto superior con perfil tirador postformado tipo "J" y cantos rectos en ABS de igual color del frente.
 Soporte: tablero MDF.
 Recubrimiento: capa melaminica interna prensada, más laminado decorativo sintético PET externo acabado en súper brillo, súper mate (SP) y texturados con film protector.
 Diseños en madera con veta horizontal.
 Contracara: simil.
 Adhesivo: cola PUR (poliuretano reactivo prensado en frio).
 Espesor: 22 mm.

■ FEATURES:

Finish: top edge with postforming profile handle type "J" and straight edges in ABS of the same front color.
 Core: MDF board.
 Covering: internal melaminica cape press plus synthetic decorative laminate PET finish super-shiny, super-matte (SP) and textured with protective film.
 Wood designs with horizontal grain.
 Backside: similar
 Adhesive: PUR glue (old press reactive polyurethane).
 Thickness: 22 mm.



MEDIDAS DE PUERTAS <i>Doors measures</i>		
UNICOLORES <i>Unicolors</i>	ALTURA <i>Height</i>	ANCHO <i>Width</i>
Máximo <i>Maximum</i>	1298 mm	2800 mm
Mínimo <i>Minimum</i>	138 mm	100 mm
VETA / Grain HORIZONTAL	ALTURA <i>Height</i>	ANCHO <i>Width</i>
Máximo <i>Maximum</i>	1298 mm	1298 mm
Mínimo <i>Minimum</i>	138 mm	100 mm
VETA / Grain VERTICAL	ALTURA <i>Height</i>	ANCHO <i>Width</i>
Máximo <i>Maximum</i>	1298 mm	1298 mm
Mínimo <i>Minimum</i>	138 mm	100 mm

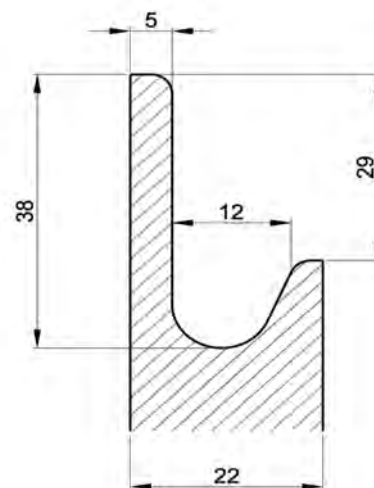

Nota: diseños PEB-085 BRILLO, PEM-051 SP, PEM-052 SP y PEW-100 METALLIC, altura máxima de puerta 1185 mm.

Note: designs PEB-085 BRILLO, PEM-051 SP, PEM-052 SP and PEW-100 METALLIC, height door maximum 1185 mm.

DISEÑOS MODELO TÁMESIS 22 mm

Tamesis 22 mm model designs



Blanco Finlandia
PEB-070 BRILLO



Crema
PEB-071 BRILLO



Lava
PEB-072 BRILLO



Gris oscuro
PEB-073 BRILLO



Rojo cherry
PEB-077 BRILLO



Negro madagascar
PEB-078 BRILLO



Café Latte
PEB-080 BRILLO



Ceniza
PEB-081 BRILLO



Burdeos teja
PEB-085 BRILLO



Aguamarina urban
PEB-086 BRILLO



Blanco Suecia
PER-001 GRAIN



Arena Sahara
PER-002 GRAIN

DISEÑOS MODELO TÁMESIS 22 mm

Tamesis 22 mm model designs

PUERTAS, COSTADOS Y REGLETAS / Doors, cover panels and fillers



**Gris Londres
PER-003 GRAIN**



**Bronce
PEW-100 METALLIC**



**Aguamarina urban
PEM-051 SP**



**Burdeos teja
PEM-052 SP**



**Cacao
PEM-055 SP**



**Ceniza
PEM-056 SP**



**Gris oscuro
PEM-057 SP**



**Café Latte
PEM-058 SP**



**Blanco Finlandia
PEM-060 SP**



**Capuchino
PEM-061 SP**



**Rojo cherry
PEM-063 SP**



**Negro madagascar
PEM-064 SP**

MODELO ONEGA 22 mm

Onega 22 mm model

■ CARACTERÍSTICAS TÉCNICAS:

Terminación: canto superior con perfil tirador postformado tipo "U" y cantos rectos en ABS de igual color del frente.

Soporte: tablero MDF.

Recubrimiento: capa melaminica interna prensada, más laminado decorativo sintético PET externo acabado en súper brillo, súper mate (SP) y texturados con film protector.

Diseños en madera con veta horizontal.

Contracara: simil.

Adhesivo: cola PUR (poliuretano reactivo prensado en frio).

Espesor: 22 mm.

■ FEATURES:

Finish: top edge with postforming profile handle type "U" and straight edges in ABS of the same front color.

Core: MDF board.

Covering: internal melaminica cape press plus synthetic decorative laminate PET finish super-shiny, super-matte (SP) and textured with protective film.

Wood designs with horizontal grain.

Backside: similar

Adhesive: PUR glue (old press reactive polyurethane).

Thickness: 22 mm.



MEDIDAS DE PUERTAS Doors measures		
UNICOLORES <i>Unicolors</i>	ALTURA <i>Height</i>	ANCHO <i>Width</i>
Máximo <i>Maximum</i>	1298 mm	2800 mm
Mínimo <i>Minimum</i>	138 mm	100 mm
VETA / Grain HORIZONTAL	ALTURA <i>Height</i>	ANCHO <i>Width</i>
Máximo <i>Maximum</i>	1298 mm	1298 mm
Mínimo <i>Minimum</i>	138 mm	100 mm
VETA / Grain VERTICAL	ALTURA <i>Height</i>	ANCHO <i>Width</i>
Máximo <i>Maximum</i>	1298 mm	1298 mm
Mínimo <i>Minimum</i>	138 mm	100 mm

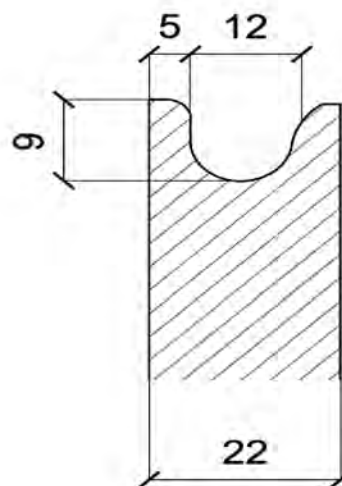

Nota: diseños PEB-085 BRILLO, PEM-051 SP, PEM-052 SP y PEW-100 METALLIC, altura máxima de puerta 1185 mm.

Note: designs PEB-085 BRILLO, PEM-051 SP, PEM-052 SP and PEW-100 METALLIC, height door maximum 1185 mm.

DISEÑOS MODELO ONEGA 22 mm

Onega 22 mm model designs



**Blanco Finlandia
PEB-070 BRILLO**



**Crema
PEB-071 BRILLO**



**Lava
PEB-072 BRILLO**



**Gris oscuro
PEB-073 BRILLO**



**Rojo cherry
PEB-077 BRILLO**



**Rojo cherry
PEB-077 BRILLO**



**Café Latte
PEB-080 BRILLO**



**Ceniza
PEB-081 BRILLO**



**Burdeos teja
PEB-085 BRILLO**



**Aguamarina urban
PEB-086 BRILLO**



**Blanco Suecia
PER-001 GRAIN**



**Arena Sahara
PER-002 GRAIN**

PUERTAS, COSTADOS Y REGLETAS / Doors, cover panels and fillers

DISEÑOS MODELO ONEGA 22 mm

Onega 22 mm model designs



Gris Londres
PER-003 GRAIN



Bronce
PEW-100 METALLIC



Aguamarina urban
PEM-051 SP



Burdeos teja
PEM-052 SP



Cacao
PEM-055 SP



Ceniza
PEM-056 SP



Gris oscuro
PEM-057 SP



Café Latte
PEM-058 SP



Blanco Finlandia
PEM-060 SP



Capuchino
PEM-061 SP



Rojo cherry
PEM-063 SP



Negro madagascar
PEM-064 SP

MODELO DANUBIO 22 mm

Danubio 22 mm model

■ **CARACTERÍSTICAS TÉCNICAS:**

Terminación: canto superior con perfil tirador postformado tipo bisel 45° y cantos rectos en ABS de igual color del frente.

Soporte: tablero MDF.

Recubrimiento: capa melaminica interna prensada, más laminado decorativo sintético PET externo acabado en súper brillo, súper mate (SP) y texturados con film protector.

Diseños en madera con veta horizontal.

Adhesivo: cola PUR (poliuretano reactivo prensado en frio).

Espesor: 22 mm.

■ **FEATURES:**

Finish: top edge with postforming profile handle type 45° bevel and straight edges in ABS of the same front color.

Core: MDF board.

Covering: internal melaminica cape press plus synthetic decorative laminate PET finish super-shiny or super-matte (SP) and protective film.

Wood designs with horizontal grain.

Backside: similar

Adhesive: PUR glue (old press reactive polyurethane).

Thickness: 22 mm.



MEDIDAS DE PUERTAS <i>Doors measures</i>		
UNICOLORS <i>Unicolors</i>	ALTURA <i>Height</i>	ANCHO <i>Width</i>
Máximo <i>Maximum</i>	1185 mm	2800 mm
Mínimo <i>Minimum</i>	138 mm	100 mm
VETA / Grain HORIZONTAL	ALTURA <i>Height</i>	ANCHO <i>Width</i>
Máximo <i>Maximum</i>	1185 mm	1298 mm
Mínimo <i>Minimum</i>	138 mm	100 mm
VETA / Grain VERTICAL	ALTURA <i>Height</i>	ANCHO <i>Width</i>
Máximo <i>Maximum</i>	1185 mm	1298 mm
Mínimo <i>Minimum</i>	138 mm	100 mm

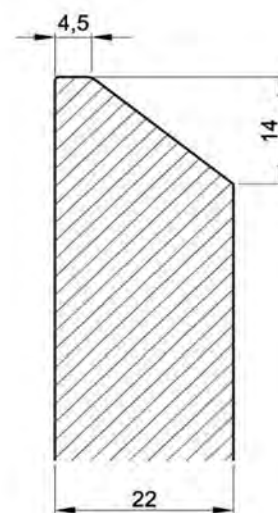

DISEÑOS MODELO DANUBIO 22 mm*Danubio 22 mm model designs*

Blanco Finlandia
PEB-070 BRILLO



Gris oscuro
PEB-073 BRILLO



Negro madagascar
PEB-078 BRILLO



Café Latte
PEB-080 BRILLO



Gris oscuro
PEM-057 SP



Café Latte
PEM-058 SP



Blanco Finlandia
PEM-060 SP



Negro madagascar
PEM-064 SP

E.

spring lbp



TOP FORM

MODELO CAMBRIDGE

Cambridge model

■ CARACTERÍSTICAS TÉCNICAS:

Puerta enmarcada lacada a dos caras sobre tablero MDF.
Cantos ligeramente redondeados. Espesor 22 mm.
Acabados brillo o mate.

■ FEATURES:

Lacquered door framed on two sides on MDF board.
Slightly rounded edges. Thickness 22 mm.
Shiny or matte finishes.

Diseño imagen / Design of the image.



Nube mate

**MODELO EVEREST**

Everest model

■ CARACTERÍSTICAS TÉCNICAS:

Puerta enmarcada lacada a dos caras sobre tablero MDF.
Cantos ligeramente redondeados. Espesor 22 mm.
Acabados brillo o mate.

■ FEATURES:

Lacquered door framed on two sides on MDF board.
Slightly rounded edges. Thickness 22 mm.
Shiny or matte finishes.

Diseño imagen / Design of the image.

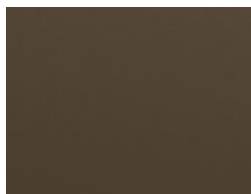

Terrosa mate



MODELO GANTE

Gante model

■ CARACTERÍSTICAS TÉCNICAS:

Puerta con tirador integrado lacada a dos caras sobre tablero MDF.
Cantos ligeramente redondeados. Espesor 22 mm.
Acabados brillo o mate.

■ FEATURES:

Door with integrated handle two sided lacquered on MDF board.
Slightly rounded edges. Thickness 22 mm.
Shiny or matte finishes.

Diseño imagen / Design of the image.



Blanco brillo

**MODELO GRECIA**

Grecia model

■ CARACTERÍSTICAS TÉCNICAS:

Puerta lacada enmarcada a dos caras sobre tablero MDF.
Cantos ligeramente redondeados. Espesor 22 mm.
Acabados brillo o mate.

■ FEATURES:

Lacquered door framed on two sides on MDF board.
Slightly rounded edges. Thickness 22 mm.
Shiny or matte finishes.

Diseño imagen / Design of the image.

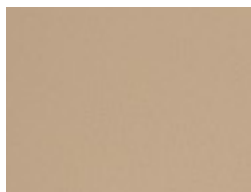

Moka mate



MODELO KANSAS PLAFLÓN LISO*Kansas flat panel model***■ CARACTERÍSTICAS TÉCNICAS:**

Puerta lacada enmarcada a dos caras sobre tablero MDF.
Cantos ligeramente redondeados. Espesor 22 mm.
Acabados brillo o mate.

■ FEATURES:

Lacquered door framed on two sides on MDF board.
Slightly rounded edges. Thickness 22 mm.
Shiny or matte finishes.

Diseño imagen / Design of the image.**Gris mate****MODELO KANSAS PLAFLÓN RAYADO***Kansas staves panel model***■ CARACTERÍSTICAS TÉCNICAS:**

Puerta lacada enmarcada a dos caras sobre tablero MDF.
Cantos ligeramente redondeados. Espesor 22 mm.
Acabados brillo o mate.

■ FEATURES:

Lacquered door framed on two sides on MDF board.
Slightly rounded edges. Thickness 22 mm.
Shiny or matte finishes.

Diseño imagen / Design of the image.**Sombra mate**

MODELO LAREDO*Laredo model***■ CARACTERÍSTICAS TÉCNICAS:**

Puerta con tirador integrado lacada a dos caras sobre tablero MDF.
Cantos ligeramente redondeados. Espesor 22 mm.
Acabados brillo o mate.

■ FEATURES:

*Door with integrated handle two sided lacquered on MDF board.
Slightly rounded edges. Thickness 22 mm.
Shiny or matte finishes.*

Diseño imagen / Design of the image.**Blanco brillo****MODELO LIMA***Lima model***■ CARACTERÍSTICAS TÉCNICAS:**

Puerta lacada enmarcada a dos caras sobre tablero MDF.
Cantos ligeramente redondeados. Espesor 22 mm.
Acabados brillo o mate.

■ FEATURES:

*Lacquered door framed on two sides on MDF board.
Slightly rounded edges. Thickness 22 mm.
Shiny or matte finishes.*

Diseño imagen / Design of the image.**Nube mate**

MODELO MADRID

Madrid model

■ CARACTERÍSTICAS TÉCNICAS:

Puerta lisa lacada a dos caras sobre tablero MDF.
Cantos ligeramente redondeados. Espesor 22 mm.
Acabados brillo o mate.

■ FEATURES:

Smooth two-sided lacquered door on MDF board.
Slightly rounded edges. Thickness 22 mm.
Shiny or matte finishes.

Diseño imagen / Design of the image.

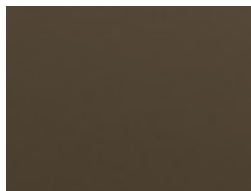

Terrosa brillo

**MODELO MAELLA 8 TIPO-2**

Maella 8 tipo-2 model

■ CARACTERÍSTICAS TÉCNICAS:

Puerta lacada enmarcada a dos caras sobre tablero MDF.
Cantos ligeramente redondeados. Espesor 22 mm.
Acabados brillo o mate.

■ FEATURES:

Lacquered door framed on two sides on MDF board.
Slightly rounded edges. Thickness 22 mm.
Shiny or matte finishes.

Diseño imagen / Design of the image.



Nube mate



MODELO MÁLAGA

Málaga model

■ CARACTERÍSTICAS TÉCNICAS:

Puerta lacada enmarcada a dos caras sobre tablero MDF.
Cantos ligeramente redondeados. Espesor 22 mm.
Acabados brillo o mate.

■ FEATURES:

Lacquered door framed on two sides on MDF board.
Slightly rounded edges. Thickness 22 mm.
Shiny or matte finishes.

Diseño imagen / Design of the image.



Nigú mate

**MODELO MARINA**

Marina model

■ CARACTERÍSTICAS TÉCNICAS:

Puerta lacada enmarcada a dos caras sobre tablero MDF.
Cantos ligeramente redondeados. Espesor 22 mm.
Acabados brillo o mate.

■ FEATURES:

Lacquered door framed on two sides on MDF board.
Slightly rounded edges. Thickness 22 mm.
Shiny or matte finishes.

Diseño imagen / Design of the image.

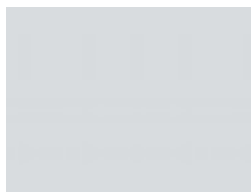

Silice seda mate / Matte silk silice



MODELO ORLEANS*Orleans model***■ CARACTERÍSTICAS TÉCNICAS:**

Puerta con tirador integrado lacada a dos caras sobre tablero MDF.
Cantos ligeramente redondeados. Espesor 22 mm.
Acabados brillo o mate.

■ FEATURES:

*Door with integrated handle two sided lacquered on MDF board.
Slightly rounded edges. Thickness 22 mm.
Shiny or matte finishes.*

Diseño imagen / Design of the image.**Nigú mate****MODELO OXFORD***Oxford model***■ CARACTERÍSTICAS TÉCNICAS:**

Puerta lacada enmarcada a dos caras sobre tablero MDF.
Cantos ligeramente redondeados. Espesor 22 mm.
Acabados brillo o mate.

■ FEATURES:

*Lacquered door framed on two sides on MDF board.
Slightly rounded edges. Thickness 22 mm.
Shiny or matte finishes.*

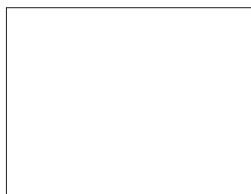
Diseño imagen / Design of the image.**Blanco mate**

MODELO PALENCIA

Palencia model

■ CARACTERÍSTICAS TÉCNICAS:

Puerta con tirador integrado lacada a dos caras sobre tablero MDF.
Cantos ligeramente redondeados. Espesor 22 mm.
Acabados brillo o mate.

■ FEATURES:

Door with integrated handle two sided lacquered on MDF board.
Slightly rounded edges. Thickness 22 mm.
Shiny or matte finishes.

Diseño imagen / Design of the image.



Nube mate

**MODELO RODAS**

Rodas model

■ CARACTERÍSTICAS TÉCNICAS:

Puerta lacada enmarcada a dos caras sobre tablero MDF.
Cantos ligeramente redondeados. Espesor 22 mm.
Acabados brillo o mate.

■ FEATURES:

Lacquered door framed on two sides on MDF board.
Slightly rounded edges. Thickness 22 mm.
Shiny or matte finishes.

Diseño imagen / Design of the image.



Gris mate



MODELO TRIPOLI

Tripoli model

■ CARACTERÍSTICAS TÉCNICAS:

Puerta con tirador integrado lacada a dos caras sobre tablero MDF.
Cantos ligeramente redondeados. Espesor 22 mm.
Acabados brillo o mate.

■ FEATURES:

Door with integrated handle two sided lacquered on MDF board.
Slightly rounded edges. Thickness 22 mm.
Shiny or matte finishes.

Diseño imagen / Design of the image.

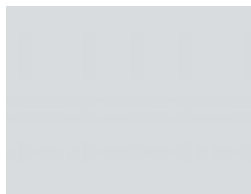

Gris perla

**MODELO VEGA**

Vega model

■ CARACTERÍSTICAS TÉCNICAS:

Puerta con tirador integrado tipo 45° lacada a dos caras sobre tablero MDF.
Cantos ligeramente redondeados. Espesor 22 mm.
Acabados brillo o mate.

■ FEATURES:

Door with integrated handle, 45° type, lacquered on two sides on MDF board.
Slightly rounded edges. Thickness 22 mm.
Shiny or matte finishes.

Diseño imagen / Design of the image.

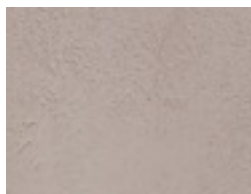

Piedra gris



MODELO XATIVA

Xativa model

■ **CARACTERÍSTICAS TÉCNICAS:**

Puerta lacada enmarcada a dos caras sobre tablero MDF.
Cantos ligeramente redondeados. Espesor 22 mm.
Acabados brillo o mate.

■ **FEATURES:**

Lacquered door framed on two sides on MDF board.
Slightly rounded edges. Thickness 22 mm.
Shiny or matte finishes.

Diseño imagen / Design of the image.



Camel mate



DISEÑOS DISPONIBLES EN ACABADOS BRILLO O MATE EN TODOS LOS MODELOS DE PUERTAS

Design available in shiny and matte in all models of doors

Azul armonía	Azul real	Blanco	Blanco roto	Camel	Gris perla
Hueso 8	Hueso 10	Menta	Moka	Mostaza	Negro
Nigú	Nube	Pergamón n°1	Piedra grafito	Piedra gris	Silice
Sombra	Terra	Terrosa	Vulcano	Metal acero inox	Metal plata

Los diseños de este catálogo pueden diferir de los acabados reales debido a las limitaciones técnicas de impresión, para obtener una visión real, consultar las muestras físicas de diseños.

The designs of this catalog may differ from the actual finishes due to the technical limitations of printing, to obtain a real vision to consult the physical samples of designs.

F.

wood wbo



TOP FORM

MODELO CALABRIA / Calabria model**■ CARACTERÍSTICAS TÉCNICAS:**

Puerta en madera de roble con marco macizo 100 mm y plafón liso rechapado con veta vertical. Espesor 22 mm.

■ FEATURES:

Oak wood door with solid frame 100 mm and veneered flat panel with vertical grain. Thickness 22 mm.

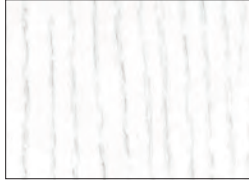
Diseños disponibles / Available designs**Roble T04****Roble P01****Color 97****MODELO GRECIA** / Grecia model**■ CARACTERÍSTICAS TÉCNICAS:**

Puerta en madera de fresno con marco macizo y plafón liso rechapado con veta vertical. Espesor 22 mm.

■ FEATURES:

Ash wood door with solid frame and veneered flat panel with vertical grain. Thickness 22 mm.

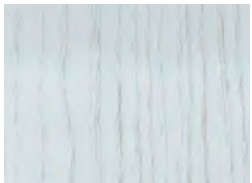
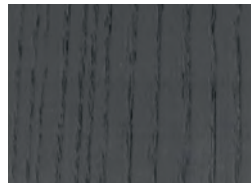
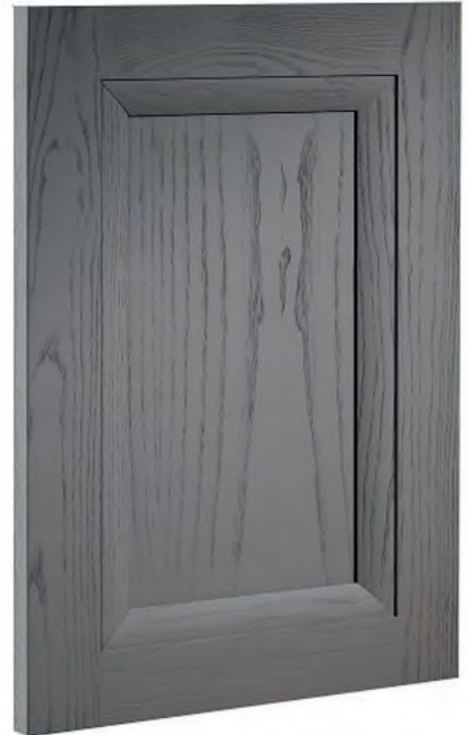
Diseños disponibles / Available designs**Fresno F06****Fresno F08****Fresno F10****Fresno F12****Fresno F13****Fresno F15**

MODELO KANSAS PLAFLÓN LISO / *Kansas flat panel model*

■ **CARACTERÍSTICAS TÉCNICAS:**

Puerta en madera de fresno con marco macizo y plafón liso rechapado con veta vertical. Espesor 22 mm.

■ **FEATURES:**

Ash wood door with solid frame and veneered flat panel with vertical grain. Thickness 22 mm.

Diseños disponibles / Available designs



Fresno D09



Fresno L09

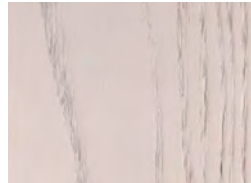

Fresno F06

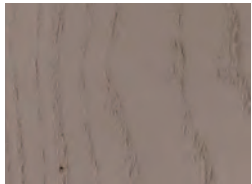

Fresno F08



Fresno F10



Fresno F12



Fresno F13

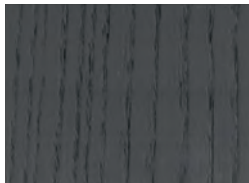

Fresno F15



MODELO KANSAS PLAFLÓN RAYADO / *Kansas staves panel model*

■ **CARACTERÍSTICAS TÉCNICAS:**

Puerta en madera de fresno con marco macizo y plafón rechapado con duelas y veta vertical. Espesor 22 mm.

■ **FEATURES:**

Ash wood door with solid frame and veneered staves panel with vertical grain. Thickness 22 mm.

Diseños disponibles / Available designs



Fresno D09



Fresno L09

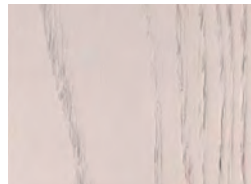

Fresno F06

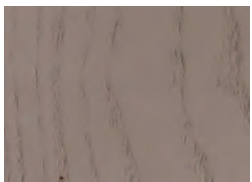

Fresno F08



Fresno F10



Fresno F12

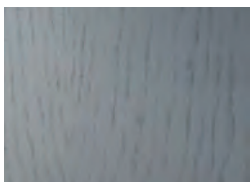

Fresno F13

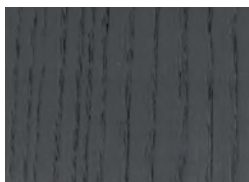

Fresno F15



MODELO LAREDO / Laredo model**■ CARACTERÍSTICAS TÉCNICAS:**

Puerta rechapada en nogal natural con tirador integrado y veta horizontal. Espesor 22 mm.

■ FEATURES:

Natural walnut veneered door integrated handle with horizontal grain. Thickness 22 mm.

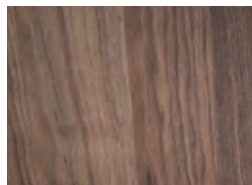
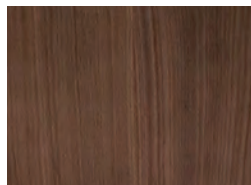
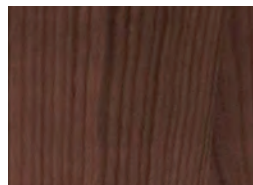
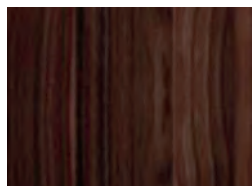
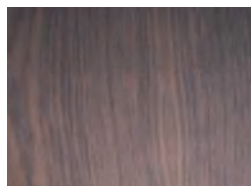
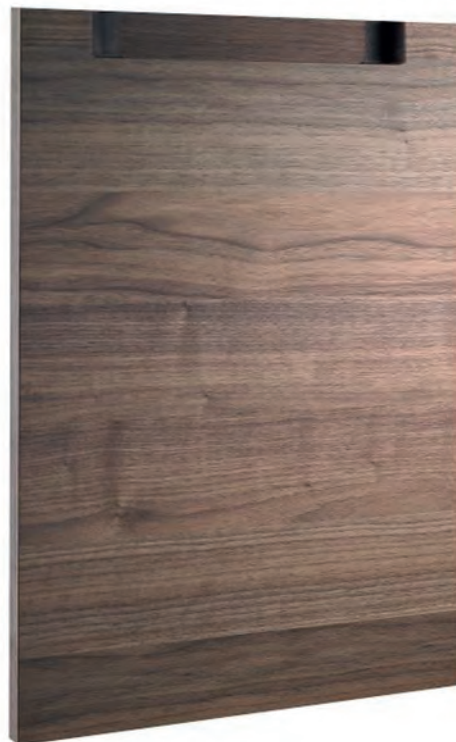
Diseños disponibles / Available designs**Nogal N1****Nogal N2****Nogal N3****Nogal N6****Nogal N9****MODELO LIMA** / Lima model**■ CARACTERÍSTICAS TÉCNICAS:**

Puerta en madera de roble nudos con marco y plafón rechapado liso con veta vertical. Espesor 22 mm.

■ FEATURES:

Oak knots wood door with frame and veneered flat panel with vertical grain. Thickness 22 mm.

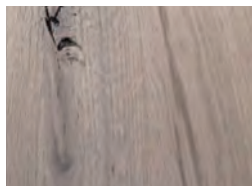
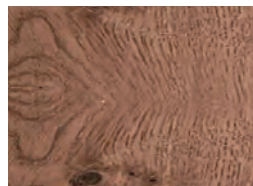
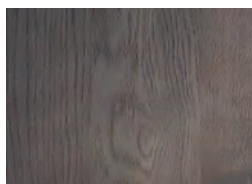
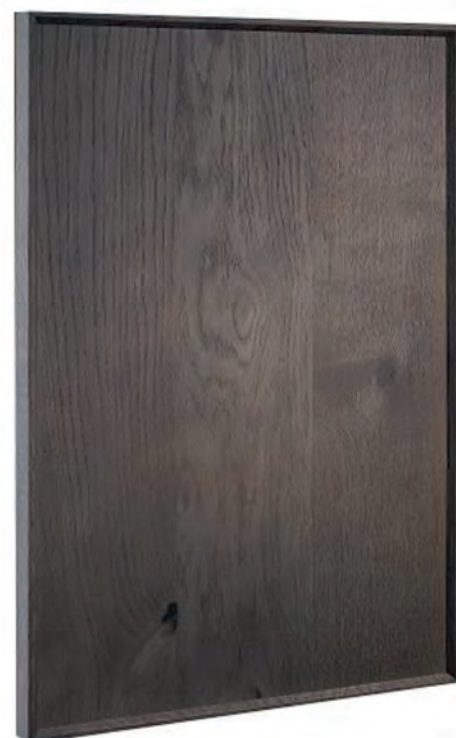
Diseños disponibles / Available designs**Roble nudos H01****Roble nudos H02****Roble nudos H03****Roble nudos H06**

MODELO MADRID / Madrid model**■ CARACTERÍSTICAS TÉCNICAS:**

Puerta rechapada en nogal natural o roble nudos con veta horizontal o vertical. Espesor 22 mm.

■ FEATURES:

Veneered door in natural walnut or oak knots with horizontal grain or vertical. Thickness 22 mm.

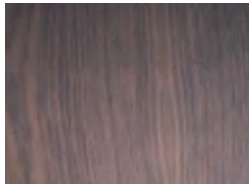
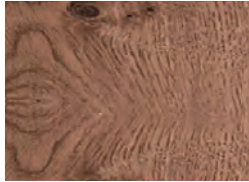
Diseños disponibles / Available designs**Nogal N1****Nogal N2****Nogal N3****Nogal N6****Nogal N9****Roble nudos H01****Roble nudos H02****Roble nudos H03****Roble nudos H06****MODELO NIZA** / Niza model**■ CARACTERÍSTICAS TÉCNICAS:**

Puerta en madera de fresno con marco macizo y plafón liso rechapado con veta vertical. Espesor 22 mm.

■ FEATURES:

Ash wood door with solid frame and veneered flat panel with vertical grain. Thickness 22 mm.

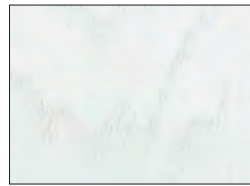
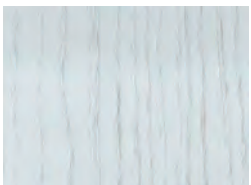
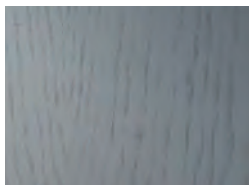
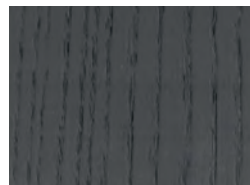
Diseños disponibles / Available designs**Fresno F06****Fresno F08****Fresno F10****Fresno F12****Fresno F13****Fresno F15**

MODELO ORLANDO / Orlando model**■ CARACTERÍSTICAS TÉCNICAS:**

Puerta en madera de fresno con marco macizo y plafón liso rechapado con veta vertical y tirador integrado. Espesor 22 mm.

■ FEATURES:

Ash wood door with solid frame and veneered flat panel with vertical grain and integrated handle. Thickness 22 mm.

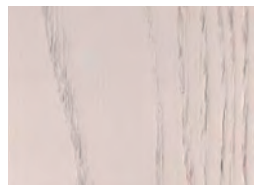
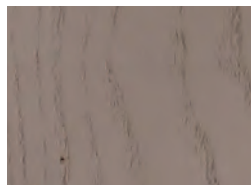
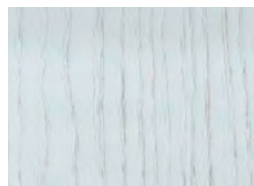
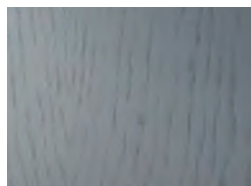
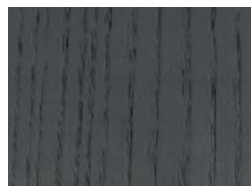
Diseños disponibles / Available designs**Fresno F06****Fresno F08****Fresno F10****Fresno F12****Fresno F13****Fresno F15****MODELO PALENCIA** / Palencia model**■ CARACTERÍSTICAS TÉCNICAS:**

Puerta rechapada en nogal natural o roble nudos con veta horizontal y tirador integrado. Espesor 22 mm.

■ FEATURES:

Veneered door in natural walnut or oak knots with horizontal grain and integrated handle. Thickness 22 mm.

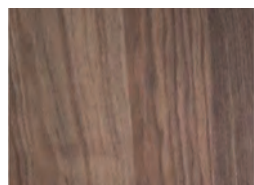
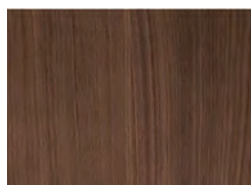
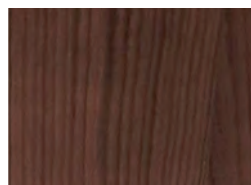
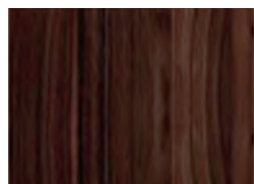
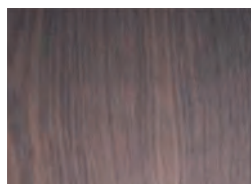
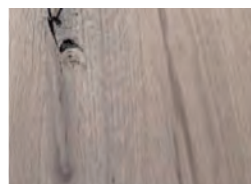
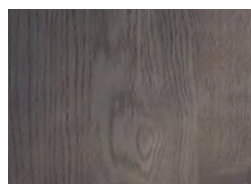
Diseños disponibles / Available designs**Nogal N1****Nogal N2****Nogal N3****Nogal N6****Nogal N9****Roble nudos H01****Roble nudos H02****Roble nudos H03****Roble nudos H06**

MODELO TRIPOLI / Tripoli model**■ CARACTERÍSTICAS TÉCNICAS:**

Puerta rechapada en nogal natural con veta horizontal y tirador integrado. Espesor 22 mm.

■ FEATURES:

Veneered door in natural walnut with horizontal grain and integrated handle. Thickness 22 mm.

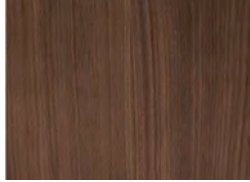
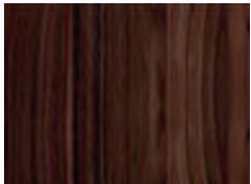
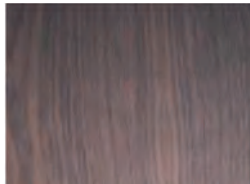
Diseños disponibles / Available designs**Nogal N1****Nogal N2****Nogal N3****Nogal N6****Nogal N9****MODELO VEGA / Vega model****■ CARACTERÍSTICAS TÉCNICAS:**

Puerta rechapada en roble nudos natural con veta vertical y tirador integrado tipo 45°. Espesor 22 mm.

■ FEATURES:

Natural knots oak veneered door with vertical grain and handle integrated 45° type. Thickness 22 mm.

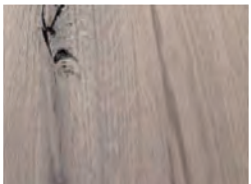
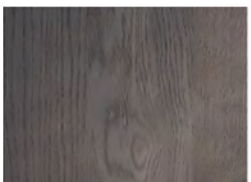
Diseños disponibles / Available designs**Roble nudos H01****Roble nudos H02****Roble nudos H03****Roble nudos H06**

G.

glass a&c



TOP FORM

MODELO LOGIK

Logik model

■ CARACTERÍSTICAS TÉCNICAS:

Vitrina de aluminio 20x19 mm.
Acabados: Plata mate y acero.
Bisagras no incluidas, hay que pedir las por separado.

■ FEATURES:

Aluminum display case 20x19 mm.
Finishes: Matte silver and steel.
Hinges not included, must be purchased separately.

Diseño imagen / Design of the image.



Transparente



Acido blanco

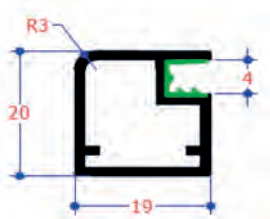

Parsol gris

**MODELO DEKOR**

Dekor model

■ CARACTERÍSTICAS TÉCNICAS:

Vitrina de aluminio 20x19 mm.
Acabado: Plata mate.
Bisagras no incluidas, hay que pedir las por separado.

■ FEATURES:

Aluminum display case 20x19 mm.
Finish: Matte silver.
Hinges not included, must be purchased separately.

Diseño imagen / Design of the image.



Transparente



Acido blanco



Parsol gris

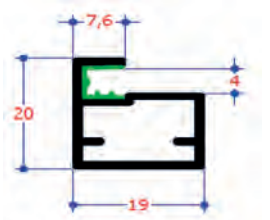

MODELO ALFIL

Alfil model

■ CARACTERÍSTICAS TÉCNICAS:

Vitrina de aluminio 45x20 mm.
Acabados: Plata mate y acero.
Bisagras no incluidas, hay que pedir las por separado.

■ FEATURES:

Aluminum display case 45x20 mm.
Finishes: Matte silver and steel.
Hinges not includes, must be purchased separately.

Diseño imagen / Design of the image.



MODELO AT VERTICAL

AT vertical model

■ CARACTERÍSTICAS TÉCNICAS:

Vitrina de aluminio 45x20 mm con tirador vertical incorporado.
Acabados: Plata mate y acero.
Bisagras no incluidas, hay que pedir las por separado.

■ FEATURES:

Aluminum display case 45x20 mm with vertical handle incorporated.
Finishes: Matte silver and steel.
Hinges not includes, must be purchased separately.

Diseño imagen / Design of the image.

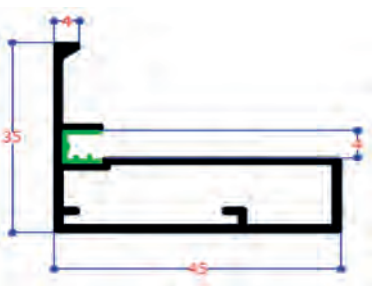
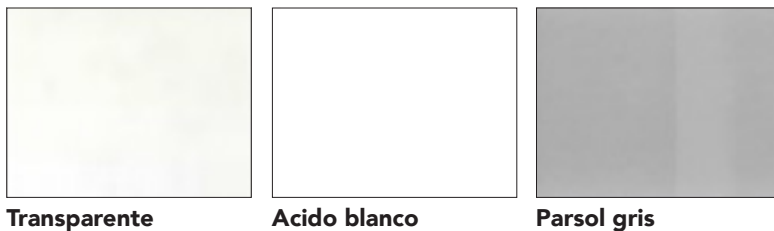

MODELO AT HORIZONTAL

AT horizontal model

■ CARACTERÍSTICAS TÉCNICAS:

Vitrina de aluminio 45x20 mm con tirador horizontal incorporado.

Acabados: Plata mate y acero.

Bisagras no incluidas, hay que pedir las por separado.

■ FEATURES:

Aluminum display case 45x20 mm with horizontal handle incorporated.

Finishes: Matte silver and steel.

Hinges not included, must be purchased separately.

Diseño imagen / Design of the image.



Transparente



Acido blanco

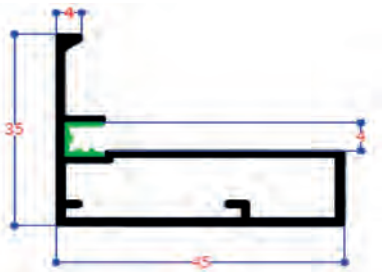

Parsol gris

**MODELO MARK**

Mark model

■ CARACTERÍSTICAS TÉCNICAS:

Vitrina de aluminio 45x19 mm.

Acabados: Plata mate y acero.

Bisagras no incluidas, hay que pedir las por separado.

■ FEATURES:

Aluminum display case 45x19 mm.

Finishes: Matte silver and steel.

Hinges not included, must be purchased separately.

Diseño imagen / Design of the image.



Transparente



Acido blanco



Parsol gris



MODELO CITY

City model

■ CARACTERÍSTICAS TÉCNICAS:

Vitrina de aluminio 50x20 mm.
Acabados: Plata mate y acero.
Bisagras no incluidas, hay que pedir las por separado.

■ FEATURES:

Aluminum display case 50x20 mm.
Finishes: Matte silver and steel.
Hinges not includes, must be purchased separately.

Diseño imagen / Design of the image.

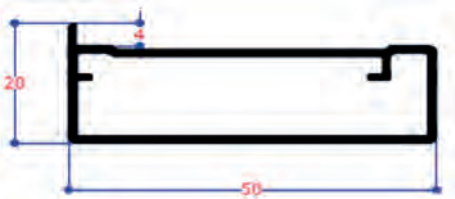

MODELO ZEN CON TIRADOR

Zen model with handle

■ CARACTERÍSTICAS TÉCNICAS:

Vitrina de aluminio 52x21 mm con tirador incorporado.
Acabados: Grafito, blanco y negro.
Bisagras no incluidas, hay que pedir las por separado.

■ FEATURES:

Aluminum display case 52x21 mm wide with handle incorporated.
Finishes: Graphite, black and white.
Hinges not includes, must be purchased separately.

Diseño imagen / Design of the image.

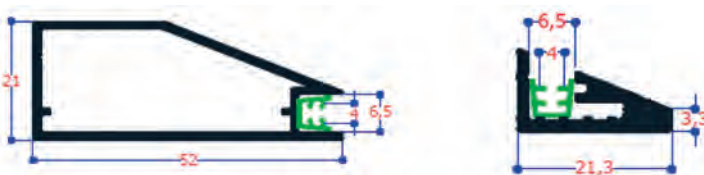



4. COMPLEMENTOS

Supplements



TOP FORM

CANTO PARA PUERTA / Edge for door**■ CARACTERÍSTICAS TÉCNICAS:**

Terminación: canto PVC en el color del diseño.

Espesor: 0,8 mm.

■ FEATURES:

Finish: PVC edge design color.

Thickness: 0,8 mm.



REFERENCIA Reference		ACABADO Texture	CÓDIGO 19 mm Code 19 mm	CÓDIGO 22 mm Code 22 mm
Aguamarina	AGM-834	SEF	9601199	9601218
Arena	ARB-810	SEF	9601119	9601124
Arena claro	ARC-837	SOFT	9601195	9601196
Blanco fresno	BLC-853	PF	9601271	9601272
Blanco polar	BLP-805	SEF	9600596	9601112
Cacao chocolate	CAC-839	SOFT	9601200	9601219
Nogal rústico	CLC-828	SYNCH	9601201	9601220
Nogal alfil	CLN-829	SYNCH	9601203	9601222
Nogal pacífico	CLO-826	SYNCH	9601204	9601223
Nogal natural	ELN-915	VH	9600549	—
Nogal negro	ENC-821	SPIRIT	9601205	9601224
Nogal italiano	EXP-823	SPIRIT	9601206	9601225
Gris antacita	GAN-811	SEF	9601120	9601123
Negro	GLP-283	SOFT	9600616	9600620
Gris claro	GRC-836	SOFT	9601207	9601226
Roble nudos blanco	HFX-176	RG	9601176	9601177
Roble nudos natural	HFX-180	RG	9601178	9601179
Roble nudos tabaco	HFX-181	RG	9601180	9601181
Roble nudos zinc	HFX-376	RG	9601208	9601227
Blanco margarita	LEB-851	VETA	9601324	—
Gris margarita	LEG-850	VETA	9601323	—
Roble café	MES-799	V.V	9601070	9601151
Roble claro	OAC-809	PW	9601109	—
Roble elegance	OAD-822	FUN	9601210	—
Roble avellana	OAM-806	FUN	9601111	9601153
Roble aneto	OAN-807	FUN	9601110	9601154
Roble tostado	OAT-808	PW	9601108	—
Olmo tostado	PNH-003	RG	9601092	9601082
Olmo natural	PNH-004	RG	9601093	9601083
Rojo	RED-840	SOFT	9601211	9601230
Roble miel	RHO-027	RG	9601002	—
Roble coñac	RSC-833	RG	9601212	9601231
Roble azucar	RSO-029	RG	9601004	9601152
Teja	RTE-835	SOFT	9601215	9601234
Roble tropical	SON-798	V.V	9601069	9601155
Nogal tostado	TOS-824	RG	9601217	9601236

■ CONDICIONES DE SUMINISTRO:

- Rollo de 150/200 metros según diseño.
- Por metros, consultar condiciones.

■ PURCHASING CONDITIONS:

- Roll of 150/300 lineal meter depending design.
- Per meters, ask about conditions.

CANTO PARA PUERTA / Edge for door

■ CARACTERISTICAS TECNICAS:

Terminación: canto PVC en el color del diseño.

Espesor: 0,8 mm.

■ FEATURES:

Finish: PVC edge design color.

Thickness: 0,8 mm.



REFERENCIA Reference		ACABADO Texture	CODIGO SU COLOR Same colour code	CODIGO CRISTAL ALU ALU cristal code
Blanco	3091	BRILLO	9600378	9600633
Blanco Islandia	3091	SEF	9600297	—
Pistacho	COV-222	BRILLO	9600280	9600658
Burdeos	GLB-247	BRILLO	9600033	9600640
Crema Suave	GLC-158	BRILLO	9600481	9600634
Gris	GLG-400	BRILLO	9600500	9600655
Aluminio	GLI-159	BRILLO	9600557	—
Berenjena	GLK-401	BRILLO	9600501	9600641
Negro	GLP-283	BRILLO	9600541	9600643
Rojo escarlata	GLR-244	BRILLO	9600322	9600639
Café	GLS-248	BRILLO	9600555	9600660
Cacao maní	INA-814	NDF	9601143	—
Blanco Groenlandia	INB-812	NDF	9601149	—
Calacatta	INC-818	NDF	9601146	—
Marquina gris	INM-817	NDF	9601145	—
Negro profundo	INN-816	NDF	9601150	—
Café mokachino	INP-813	NDF	9601142	—
Grafito	INT-815	NDF	9601144	—
Talco	LAR-770	SOFT	9600899	—
Mármol marquina	MAC-820	STUCCO	9601148	—
Mármol emperador	MAY-819	STUCCO	9601147	—
Gris metálico	MTG-765	BRILLO	9600713	—
Óxido azul	OXA-445	WAX	9600898	—
Óxido marrón	OXM-444	WAX	9600874	—
Pino kenia	PIR-022	SOFT	9600189	—
Pino viejo	PIV-023	SOFT	9600572	—
Roble natural	RON-803	OP	9601104	—
Cemento	TRC-443	WAX	9600875	—

■ CONDICIONES DE SUMINISTRO:

- Rollo de 150/200 metros según diseño.
- Por metros, consultar condiciones.

■ PURCHASING CONDITIONS:

- Roll of 150/300 lineal meter depending design.
- Per meters, ask about conditions.

LAMINADO / Laminate

■ CARACTERÍSTICAS TÉCNICAS:

Recubrimiento: laminado decorativo HPL de 0,7 mm de espesor y film protector.

■ FEATURES:

Covering: 0.7 mm thick decorative HPL laminate and protective film.



REFERENCIA Reference		ACABADO Texture	MEDIDA Measure	CÓDIGO Code
Blanco	3091	BRILLO	3600x1530	9101553
Blanco Islandia	3091	SEF	3600x1400	9100069
Pistacho	COV-222	BRILLO	3600x1400	9101596
Burdeos	GLB-247	BRILLO	3600x1530	9100388
Crema Suave	GLC-158	BRILLO	3600x1400	9102237
Gris	GLG-400	BRILLO	3600x1530	9101391
Aluminio	GLI-159	BRILLO	3600x1400	9101603
Berenjena	GLK-401	BRILLO	3600x1400	9101658
Negro	GLP-283	BRILLO	3600x1530	9101213
Rojo escarlata	GLR-244	BRILLO	3600x1400	9101937
Café	GLS-248	BRILLO	3600x1400	9100389
Cacao maní	INA-814	NDF	3600x1400	9103621
Blanco Groenlandia	INB-812	NDF	3600x1400	9102217
Calacatta	INC-818	NDF	3600x1400	9103359
Marquina gris	INM-817	NDF	3600x1400	9103624
Negro profundo	INN-816	NDF	3600x1400	9103623
Café mokachino	INP-813	NDF	3600x1400	9103008
Grafito	INT-815	NDF	3600x1400	9103622
Talco	LAR-770	SOFT	3600x1530	9102054
Mármol marquina	MAC-820	STUCCO	3600x1400	9103626
Mármol emperador	MAY-819	STUCCO	3600x1400	9103625
Gris metálico	MTG-765	BRILLO	3600x1400	9102449
Óxido azul	OXA-445	WAX	3600x1400	9101515
Óxido marrón	OXM-444	WAX	3600x1400	9101516
Pino kenia	PIR-022	SOFT	3600x1400	9102113
Pino viejo	PIV-023	SOFT	3600x1400	9102138
Roble natural	RON-803	OP	3600x1530	9103510
Cemento	TRC-443	WAX	3600x1400	9101527

■ CONDICIONES DE SUMINISTRO:

- Paquete estándar 1 unidad por diseño.

■ PURCHASING CONDITIONS:

- Standard package 1 unit per design.

MEDIDAS

Dimensions

3600x1400 mm según diseño / Depending design

3600x1530 mm según diseño / Depending design

CANTO PARA PUERTA / Edge for door

■ **CARACTERISTICAS TECNICAS:**

Terminación: canto PVC en el color del diseño.

Espesor: 0,8 mm.

■ **FEATURES:**

Finish: PVC edge design color.

Thickness: 0,8 mm.



REFERENCIA Reference		ACABADO Texture	CODIGO SU COLOR Same colour code	CODIGO VIDRIO Glass code
Blanco Finlandia	PEB-070	BRILLO	9600892	9601302
Crema	PEB-071	BRILLO	9600917	9601303
Lava	PEB-072	BRILLO	9600918	9601304
Gris oscuro	PEB-073	BRILLO	9600919	9601305
Rojo cherry	PEB-077	BRILLO	9600774	9601306
Negro madagascar	PEB-078	BRILLO	9600773	9601307
Café Latte	PEB-080	BRILLO	9600997	9601308
Ceniza	PEB-081	BRILLO	9601012	9601309
Burdeos teja	PEB-085	BRILLO	9601279	9601310
Aguamarina urban	PEB-086	BRILLO	9601280	9601311
Roble claro	OAC-809	BRILLO	9601354	9601313
Roble elegance	OAD-822	BRILLO	9601356	9601312
Roble avellana	OAM-806	BRILLO	9601352	9601314
Roble aneto	OAN-807	BRILLO	9601353	9601315
Roble tostado	OAT-808	BRILLO	9601355	9601316
Aguamarina urban	PEM-051	SP	9601281	—
Burdeos teja	PEM-052	SP	9601282	—
Cacao	PEM-055	SP	9601014	—
Ceniza	PEM-056	SP	9601015	—
Gris oscuro	PEM-057	SP	9601016	—
Café Latte	PEM-058	SP	9601017	—
Blanco Finlandia	PEM-060	SP	9600912	—
Capuchino	PEM-061	SP	9600913	—
Rojo cherry	PEM-063	SP	9600915	—
Negro madagascar	PEM-064	SP	9600916	—
Roble claro	OAC-809	SP	9601319	—
Roble elegance	OAD-822	SP	9601321	—
Roble avellana	OAM-806	SP	9601317	—
Roble aneto	OAN-807	SP	9601318	—
Roble tostado	OAT-808	SP	9601320	—

■ **CONDICIONES DE SUMINISTRO:**

- Rollo de 150/200 metros según diseño.
- Por metros, consultar condiciones.

■ **PURCHASING CONDITIONS:**

- Roll of 150/300 lineal meter depending design.
- Per meters, ask about conditions.

CANTO PARA PUERTA / Edge for door**■ CARACTERÍSTICAS TÉCNICAS:**

Terminación: canto PVC en el color del diseño.

Espesor: 0,8 mm.

■ FEATURES:

Finish: PVC edge design color.

Thickness: 0,8 mm.

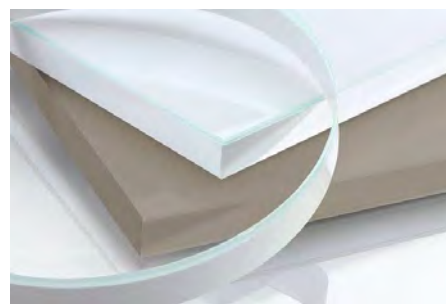

REFERENCIA Reference		ACABADO Texture	CÓDIGO 19 mm Code 19 mm	CÓDIGO 22 mm Code 22 mm
Blanco Finlandia	PEB-070	BRILLO	—	9601052
Crema	PEB-071	BRILLO	—	9601053
Lava	PEB-072	BRILLO	—	9601054
Gris oscuro	PEB-073	BRILLO	—	9601055
Rojo cherry	PEB-077	BRILLO	—	9601056
Negro madagascar	PEB-078	BRILLO	—	9601106
Café Latte	PEB-080	BRILLO	—	9601057
Ceniza	PEB-081	BRILLO	—	9601058
Burdeos teja	PEB-085	BRILLO	—	9601237
Aguamarina urban	PEB-086	BRILLO	—	9601238
Blanco Suecia	PER-001	GRAIN	—	9601241
Arena Sahara	PER-002	GRAIN	—	9601242
Gris Londres	PER-003	GRAIN	—	9601243
Bronce	PEW-100	METALLIC	—	9601244
Aguamarina urban	PEM-051	SP	—	9601239
Burdeos teja	PEM-052	SP	—	9601240
Cacao	PEM-055	SP	—	9601059
Ceniza	PEM-056	SP	—	9601060
Gris oscuro	PEM-057	SP	—	9601061
Café Latte	PEM-058	SP	—	9601062
Blanco Finlandia	PEM-060	SP	—	9601063
Capuchino	PEM-061	SP	—	9601064
Rojo cherry	PEM-063	SP	—	9601065
Negro madagascar	PEM-064	SP	—	9601066

■ CONDICIONES DE SUMINISTRO:

- Rollo de 150/200 metros según diseño.
- Por metros, consultar condiciones.

■ PURCHASING CONDITIONS:

- Roll of 150/300 lineal meter depending design.
- Per meters, ask about conditions.

LAMINADO / Laminate

■ **CARACTERISTICAS TECNICAS:**

Recubrimiento: laminado decorativo HPL de 0,7 mm de espesor y film protector.

■ **FEATURES:**

Covering: 0.7 mm thick decorative HPL laminate and protective film.



			LAMINADO / Laminate		TIRA LAMINADO / Laminate strip	
REFERENCIA Reference	ACABADO Texture	MEDIDA Measure	CÓDIGO Code	MEDIDA Measure	CÓDIGO Code	
Blanco Islandia	3091	SEF	3600x1400	9100069	3600x0045	9102475
Negro nieve	3306	BRILLO	3600x1400	9101644	3600x0045	—
Blanco nieve	3308	BRILLO	3600x1400	9101643	3600x0045	—
Lima nieve	3309	BRILLO	3600x1400	9101650	3600x0045	—
Blanco antique nieve	3314	BRILLO	3600x1400	9101645	3600x0045	—
Burdeos nieve	3315	BRILLO	3600x1400	9101648	3600x0045	—
Rojo nieve	3316	BRILLO	3600x1400	9101646	3600x0045	—
Gris metalizado	8001	TF	3600x1400	9101412	3600x0045	—
Annapurna lava	ANA-043	ANNAPURNA	3600x1400	9103111	3600x0045	—
Annapurna gris	ANC-042	ANNAPURNA	3600x1400	9103110	3600x0045	9103321
Annapurna grafito	ANG-044	ANNAPURNA	3600x1400	9103112	3600x0045	9103325
Annapurna crema	ANM-047	ANNAPURNA	3600x1400	9103109	3600x0045	9103324
Annapurna negro	ANN-048	ANNAPURNA	3600x1400	9103113	3600x0045	—
Marmol Calacatta	CAL-800	FEEL	3600x1400	9103674	3600x0045	9103503
Tablillas	CAT-178	SOFT	3600x1400	9101159	3600x0045	9102191
Cemento plata	CEM-849	FEEL	3600x1400	9103732	3600x0045	—
Mineral Apollo	DEA-843	OLYMPUS	3600x1400	9103737	1400x0045	9103845
Cantera Hermes	DEN-841	OLYMPUS	3600x1400	9103733	3600x0045	—
Mineral Zeus	DEZ-842	OLYMPUS	3600x1400	9103736	3600x0045	—
Roble vintage	EVE-801	FEEL	3600x1400	9103673	3600x0045	—
Calacatta natural	F-271	BRILLO	3600x1400	9103344	3600x0045	—
Granito negro	F-281	BRILLO	3600x1400	9100263	3600x0045	—
Negro encerado	GLP-283	ROCK	3600x1400	9103383	3600x0045	9103609
Haya	H-203	SOFT	3600x1400	9100022	3600x0045	—
Cacao maní	INA-814	NDF	3600x1400	9103615	3600x0045	9103794
Blanco Groenlandia	INB-812	NDF	3600x1400	9103613	3600x0045	—
Calacatta	INC-818	NDF	3600x1400	9103619	3600x0045	9103633
Marquina gris	INM-817	NDF	3600x1400	9103618	3600x0045	9103632
Negro profundo	INN-816	NDF	3600x1400	9103617	3600x0045	9103796
Café mokachino	INP-813	NDF	3600x1400	9103614	3600x0045	9103793
Grafito	INT-815	NDF	3600x1400	9103616	3600x0045	9103795
Arena duna	KMM-740	WAX	3600x1400	9103407	3600x0045	—
Pino Talco	LAR-770	SOFT	3600x1530	9102054	3600x0045	—
Mármol marquina	MAC-820	STUCCO	3600x1400	9103626	3600x0045	9103672
Mármol emperador	MAY-819	STUCCO	3600x1400	9103625	1400x0045	9103645
Azul metálico	MTA-768	BRILLO	3600x1400	9101923	3600x0045	—
Gris metálico	MTG-765	BRILLO	3600x1400	9102449	3600x0045	—

■ **CONDICIONES DE SUMINISTRO:**

- Paquete estándar 1 unidad por diseño.

■ **PURCHASING CONDITIONS:**

- Standard package 1 unit per design.

MEDIDAS Dimensions
3600x1400 mm según diseño / Depending design
3600x1530 mm según diseño / Depending design

LAMINADO / Laminate

■ CARACTERÍSTICAS TÉCNICAS:

Recubrimiento: laminado decorativo HPL de 0,7 mm de espesor y film protector.

■ FEATURES:

Covering: 0.7 mm thick decorative HPL laminate and protective film.



			LAMINADO / Laminate		TIRA LAMINADO / Laminate strip	
REFERENCIA Reference		ACABADO Texture	MEDIDA Measure	CÓDIGO Code	MEDIDA Measure	CÓDIGO Code
Marquina	NMN-744	BRILLO	3600x1400	9102974	3600x0045	9102203
Marmol paraiso	OAS-278	STONE	3600x1400	9103607	3600x0045	—
Óxido azulado	OXA-445	WAX	3600x1400	9103405	3600x0045	—
Óxido marrón	OXM-444	WAX	3600x1400	9103403	3600x0045	9102196
Pizarra	PIZ-224	SOFT	3600x1400	9100573	3600x0045	—
Granito salmón	PP-5564	BRILLO	3600x1400	9100626	3600x0045	—
Granito labrador	PP-5568	BRILLO	3600x1400	9100628	3600x0045	—
Haya alistonada	PP-7581	SOFT	3600x1400	9101147	3600x0045	—
Wengue	PSF-143	SOFT	3600x1400	9100681	3600x0045	—
Granito gala	RG-102	BRILLO	3600x1400	9100695	3600x0045	—
Roble natural	RON-803	OPEN PORE	3600x1530	9103510	3600x0045	9103540
Roble tostado	ROS-804	OPEN PORE	3600x1530	9103511	3600x0045	9103541
Pizarra negra	SLN-440	ROCK	3600x1400	9103527	3600x0045	9103550
Marquina elegant	STE-848	TOUCH	3600x1400	9103730	3600x0045	—
Marmol Atenea	STG-846	BRILLO	3600x1400	9103729	1400x0045	9103844
Marmol Onyx	STM-847	BRILLO	3600x1400	9103731	1400x0045	9103843
Terrazo claro	TEC-844	OLYMPUS	3600x1400	9103734	3600x0045	—
Terrazo oscuro	TEO-845	OLYMPUS	3600x1400	9103735	1400x0045	9103846
Travertino	TRA-260	STONE	3600x1400	9103608	3600x0045	—
Cemento	TRC-443	WAX	3600x1400	9103404	3600x0045	9102197
Cemento claro	VEC-773	WAX	3600x1400	9103406	3600x0045	—
Cemento oscuro	VEO-774	WAX	3600x1400	9102521	3600x0045	—

■ CONDICIONES DE SUMINISTRO:

- Paquete estándar 1 unidad por diseño.

■ PURCHASING CONDITIONS:

- Standard package 1 unit per design.

MEDIDAS

Dimensions

3600x1400 mm según diseño / Depending design

3600x1530 mm según diseño / Depending design

5.

MODULOS

Cabinets



TOP FORM

A.

MODULOS EN KIT

Flat pack cabinets



TOP FORM

CALIDAD BASICA / Basic Quality**■ CARACTERISTICAS TECNICAS:**

- Tablero melaminico MFC con particulas de alta densidad en 16 mm de espesor.
- Cantos polilaminados de 0,8 mm y 0,4 mm en lados ocultos.
- Soporte de baldas con sistema antivuelco, taladros para fijación de estantes en 5 mm Ø.
- Taladros para bases de bisagras.
- Contiene elementos de ensamblado.
- Diseño en blanco.

■ FEATURES:

- 16 mm melamine board.
- 0,8 mm polilaminated edgebanding on visible side and 0,4 mm on hiddens side.
- Shelf brackets with collapsible system, pre-drilled 5 mm Ø for the shelves.
- Pre-drilled holes for mounting plates of hinges.
- Include assembly fittings.
- White and beech designs..

**CALIDAD PREMIUM HF / HF Premium Quality****■ CARACTERISTICAS TECNICAS:**

- Tablero melaminico MFC con particulas de alta densidad en 16 mm de espesor, tratamiento hidrófugo.
- Diseño en blanco sujeto a nueva normativa **"CARB2 compliant"**.
- Cantos polilaminados de 0,8 mm y 0,4 mm en lados ocultos.
- Soporte de baldas con mecanismos de sujeción "Clock system" con taladros para fijación de estantes en 3 mm Ø.
- Taladros para bases de bisagras.
- Contiene elementos de ensamblado.
- Diseños en blanco, gris y textil.

■ FEATURES:

- 16 mm moisture resistant melamine board.
- White design subject to new "CARB2 compliant" regulations.
- 0,8 mm polilaminated edgebanding on visible side and 0,4 mm on hiddens side.
- "Clock system" shelf brackets, pre-drilled 3 mm Ø holes for the shelves.
- Pre-drilled holes for mounting plates of hinges.
- Include assembly fittings.
- White, grey and textile designs..
- Include assembly fittings.
- White and beech designs.



BAJO ESTANDAR, PROFUNDIDAD 580 mm.

Standard base unit, depth 580 mm

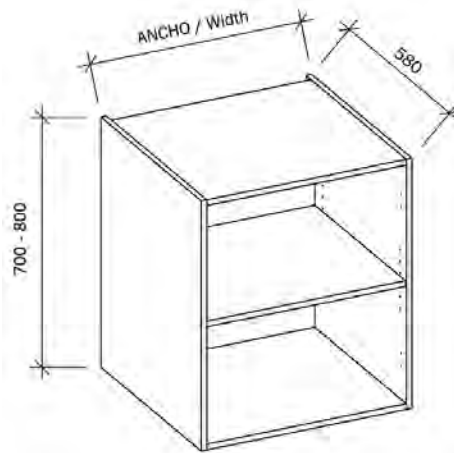
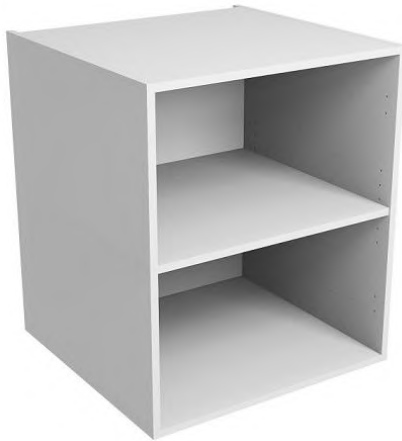

CARACTERISTICAS / Features				CÓDIGO / Code			
ALTURA Height	ANCHO Width	PESO UNIDAD Weight unit	UNIDAD PALET Units pallet	BLANCO White	BLANCO HF HF White	GRIS HF HF Grey	TEXTIL HF HF Textile
700	150	10 kg.	24	—	7002729	—	—
	300	15 kg.	24	7000263	7002730	7002640	7002562
	350	16 kg.	24	7000265	7002748	7002641	7002563
	400	17 kg.	24	7000267	7002731	7002642	7002564
	450	18 kg.	20	7000269	7002732	7002643	7002565
	500	19 kg.	20	7000271	7002733	7002644	7002566
	600	21 kg.	20	7000273	7002734	7002645	7002567
	700	23 kg.	10	7000275	7002749	7002646	7002568
	800	25 kg.	10	7000277	7002735	7002647	7002569
	900	27 kg.	10	7000279	7002750	7002648	7002570
	1000	29 kg.	10	7000281	7002736	7002649	7002571
	1200	34 kg.	10	7000284	—	—	—

CARACTERISTICAS / Features				CÓDIGO / Code			
ALTURA Height	ANCHO Width	PESO UNIDAD Weight unit	UNIDAD PALET Units pallet	BLANCO White	BLANCO HF HF White	GRIS HF HF Grey	TEXTIL HF HF Textile
800	150	10 kg.	24	—	—	—	—
	300	17,1 kg.	24	7002673	—	—	—
	350	18,5 kg.	24	7002674	—	—	—
	400	19,5 kg.	24	7002675	—	—	—
	450	20,5 kg.	20	7002676	—	—	—
	500	21,5 kg.	20	7002677	—	—	—
	600	24 kg.	20	7002678	—	—	—
	700	26,5 kg.	10	7002679	—	—	—
	800	28,5 kg.	10	7002680	—	—	—
	900	30,5 kg.	10	7002681	—	—	—
	1000	33 kg.	10	7002682	—	—	—

■ **CONDICIONES DE SUMINISTRO:**

- Palet completo.
- Por unidad, consultar condiciones.

■ **PURCHASING CONDITIONS:**

- Full pallet.
- Per unit, ask about conditions

BAJO FREGADERO, PROFUNDIDAD 580 mm.

Sink base unit, depth 580 mm.

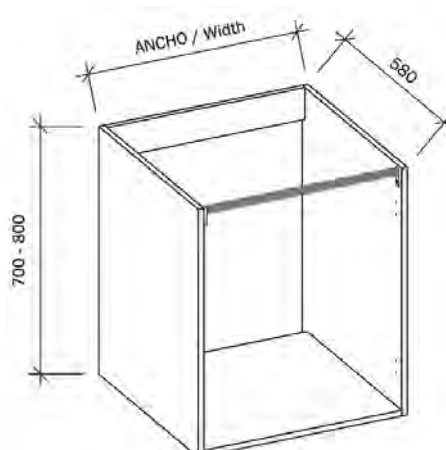

CARACTERISTICAS / Features				CÓDIGO / Code			
ALTURA Height	ANCHO Width	PESO UNIDAD Weight unit	UNIDAD PALET Units pallet	BLANCO White	BLANCO HF HF White	GRIS HF HF Grey	TEXTIL HF HF Textile
700	450	14 kg.	24	7000510	—	—	—
	500	14,5 kg.	24	7000512	7002751	7002651	7002573
	600	15,5 kg.	24	7000514	7002737	7002652	7002574
	700	16,5 kg.	24	7000516	—	7002653	7002575
	800	17,5 kg.	24	7000518	7002738	7002654	7002576
	900	18,5 kg.	24	7000520	7002739	7002655	7002577
	1000	19,5 kg.	24	7000522	—	7002656	7002578
	1200	23,5 kg.	24	7000524	—	—	—

CARACTERISTICAS / Features				CÓDIGO / Code			
ALTURA Height	ANCHO Width	PESO UNIDAD Weight unit	UNIDAD PALET Units pallet	BLANCO White	BLANCO HF HF White	GRIS HF HF Grey	TEXTIL HF HF Textile
800	500	16,5 kg.	24	7002684	—	—	—
	600	17,5 kg.	24	7002685	—	—	—
	700	18,5 kg.	24	7002686	—	—	—
	800	20 kg.	24	7002687	—	—	—
	900	21,5 kg.	24	7002688	—	—	—
	1000	22,5 kg.	24	7002689	—	—	—

CONDICIONES DE SUMINISTRO:

- Palet completo.
- Por unidad, consultar condiciones.

PURCHASING CONDITIONS:

- Full pallet.
- Per unit, ask about conditions

BAJO RINCON ANGULAR, PROFUNDIDAD 580 mm.

"L" corner base unit, depth 580 mm.

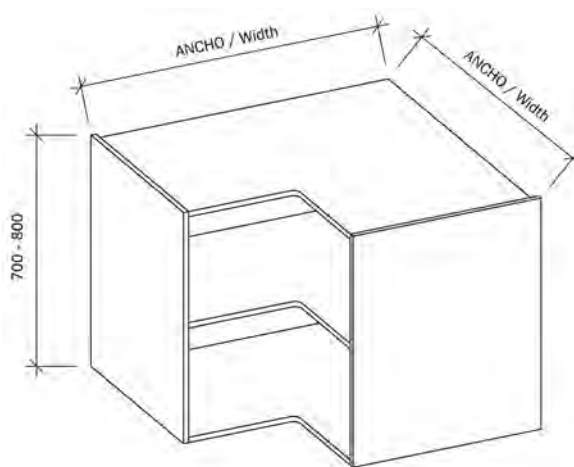

CARACTERISTICAS / Features				CÓDIGO / Code			
ALTURA Height	ANCHO Width	PESO UNIDAD Weight unit	UNIDAD PALET Units pallet	BLANCO White	BLANCO HF HF White	GRIS HF HF Grey	TEXTIL HF HF Textile
700	930	38 kg.	8	7001242	7002740	7002657	7002579
	1030	42 kg.	8	7000006	—	7002658	7002580

CARACTERISTICAS / Features				CÓDIGO / Code			
ALTURA Height	ANCHO Width	PESO UNIDAD Weight unit	UNIDAD PALET Units pallet	BLANCO White	BLANCO HF HF White	GRIS HF HF Grey	TEXTIL HF HF Textile
800	930	43,5 kg.	8	7002671	—	—	—
	1030	48 kg.	8	7002672	—	—	—

■ **CONDICIONES DE SUMINISTRO:**

- Palet completo.
- Por unidad, consultar condiciones.

■ **PURCHASING CONDITIONS:**

- Full pallet.
- Per unit, ask about conditions

ALTO ESTANDAR, PROFUNDIDAD 330 mm.

Standard wall unit, depth 330 mm.

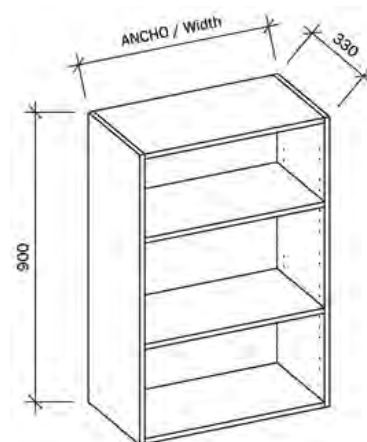
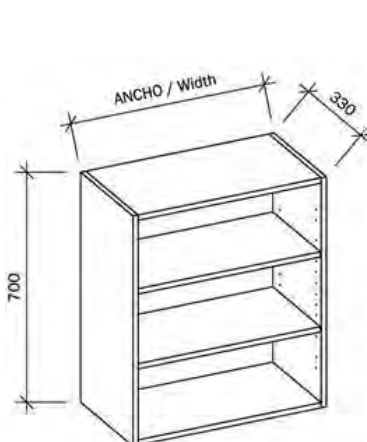

CARACTERISTICAS / Features				CÓDIGO / Code			
ALTURA Height	ANCHO Width	PESO UNIDAD Weight unit	UNIDAD PALET Units pallet	BLANCO White	BLANCO HF HF White	GRIS HF HF Grey	TEXTIL HF HF Textile
700	300	10 kg.	36	7000003	7002711	7002597	7002520
	350	11 kg.	36	7000005	—	7002598	7002521
	400	12 kg.	36	7000007	7002712	7002599	7002522
	450	13 kg.	24	7000009	7002713	7002600	7002523
	500	14 kg.	24	7000011	7002714	7002601	7002524
	600	15,5 kg.	24	7000013	7002715	7002602	7002525
	700	17 kg.	16	7000015	—	7002603	7002526
	800	18,5 kg.	16	7000017	7002716	7002604	7002527
	900	20 kg.	16	7000019	—	7002605	7002528
	1000	21,5 kg.	16	7000021	—	7002606	7002529

CARACTERISTICAS / Features				CÓDIGO / Code			
ALTURA Height	ANCHO Width	PESO UNIDAD Weight unit	UNIDAD PALET Units pallet	BLANCO White	BLANCO HF HF White	GRIS HF HF Grey	TEXTIL HF HF Textile
700	300	11,5 kg.	36	7000036	7002718	7002607	7002537
	350	12,5 kg.	36	7000038	—	7002608	7002538
	400	13,5 kg.	36	7000040	7002719	7002609	7002539
	450	14,5 kg.	24	7000042	7002720	7002610	7002540
	500	15,5 kg.	24	7000044	7002721	7002611	7002541
	600	17 kg.	24	7000046	7002722	7002612	7002542
	700	18,5 kg.	16	7000048	7002745	7002613	7002543
	800	20 kg.	16	7000050	7002723	7002614	7002544
	900	21,5 kg.	16	7000052	—	7002615	7002545
	1000	23 kg.	16	7000054	—	7002616	7002546

■ **CONDICIONES DE SUMINISTRO:**

- Palet completo.
- Por unidad, consultar condiciones.

■ **PURCHASING CONDITIONS:**

- Full pallet.
- Per unit, ask about conditions

ALTO ESCURREPLATOS, PROFUNDIDAD 330 mm.

Plate rack wall unit, depth 330 mm.

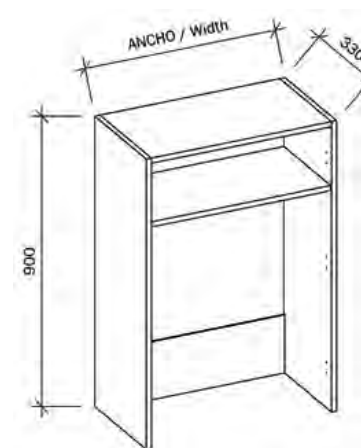
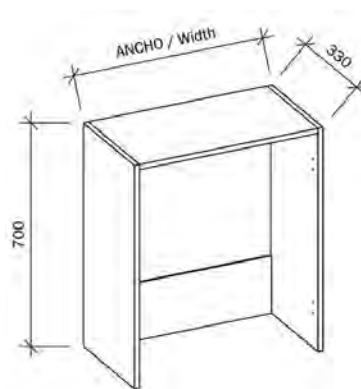

CARACTERISTICAS / Features				CÓDIGO / Code			
ALTURA Height	ANCHO Width	PESO UNIDAD Weight unit	UNIDAD PALET Units pallet	BLANCO White	BLANCO HF HF White	GRIS HF HF Grey	TEXTIL HF HF Textile
700	600	9,5 kg.	28	7000410	—	—	—
	900	12,5 kg.	16	7000416	—	—	—

CARACTERISTICAS / Features				CÓDIGO / Code			
ALTURA Height	ANCHO Width	PESO UNIDAD Weight unit	UNIDAD PALET Units pallet	BLANCO White	BLANCO HF HF White	GRIS HF HF Grey	TEXTIL HF HF Textile
900	600	13 kg.	28	7000423	—	—	—
	900	16,75 kg.	16	7000429	—	—	—

■ **CONDICIONES DE SUMINISTRO:**

- Palet completo.
- Por unidad, consultar condiciones.

■ **PURCHASING CONDITIONS:**

- Full pallet.
- Per unit, ask about conditions

ALTO RINCON ANGULAR, PROFUNDIDAD 330 mm.

"L" corner wall unit, depth 330 mm.

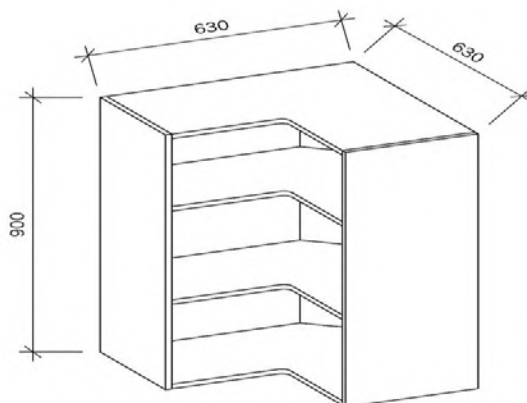
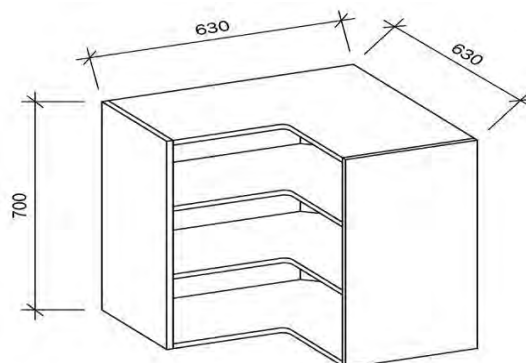

CARACTERISTICAS / Features				CÓDIGO / Code			
ALTURA Height	ANCHO Width	PESO UNIDAD Weight unit	UNIDAD PALET Units pallet	BLANCO White	BLANCO HF HF White	GRIS HF HF Grey	TEXTIL HF HF Textile
700	630	22 kg.	20	7001190	7002717	7002629	7002530

CARACTERISTICAS / Features				CÓDIGO / Code			
ALTURA Height	ANCHO Width	PESO UNIDAD Weight unit	UNIDAD PALET Units pallet	BLANCO White	BLANCO HF HF White	GRIS HF HF Grey	TEXTIL HF HF Textile
900	630	24 kg.	20	7001193	7002724	7002630	7002547

CONDICIONES DE SUMINISTRO:

- Palet completo.
- Por unidad, consultar condiciones.

PURCHASING CONDITIONS:

- Full pallet.
- Per unit, ask about conditions

ALTO ABATIBLE, PROFUNDIDAD 330 mm.

Wall large unit, depth 330 mm.

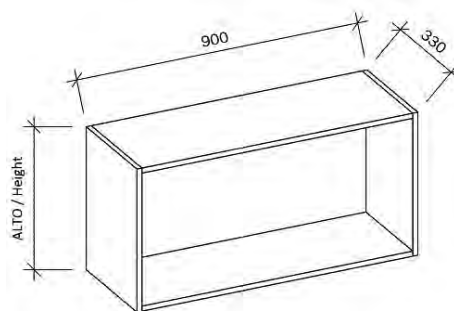
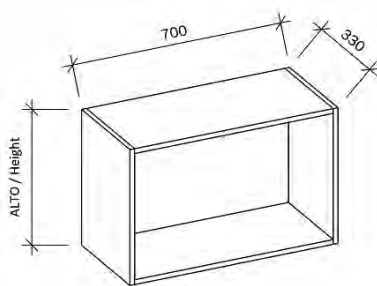
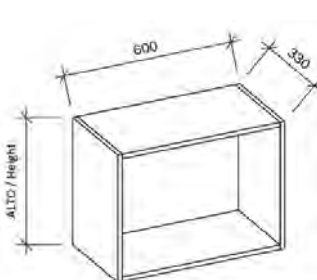
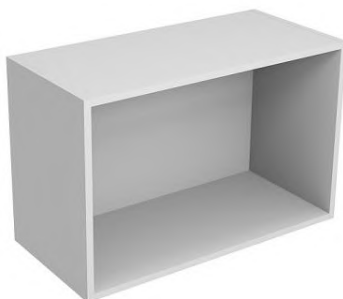
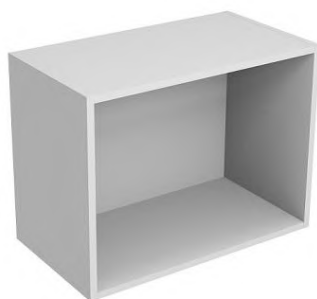

CARACTERISTICAS / Features				CÓDIGO / Code			
ALTURA Height	ANCHO Width	PESO UNIDAD Weight unit	UNIDAD PALET Units pallet	BLANCO White	BLANCO HF HF White	GRIS HF HF Grey	TEXTIL HF HF Textile
350	600	8 kg.	36	7000666	7002725	7002631	7002554
	700	8,5 kg.	36	7001314	—	7002632	7002555
	900	10,5 kg.	36	7000668	—	—	—

CARACTERISTICAS / Features				CÓDIGO / Code			
ALTURA Height	ANCHO Width	PESO UNIDAD Weight unit	UNIDAD PALET Units pallet	BLANCO White	BLANCO HF HF White	GRIS HF HF Grey	TEXTIL HF HF Textile
400	600	8,5 kg.	36	7000670	7002746	—	—

CARACTERISTICAS / Features				CÓDIGO / Code			
ALTURA Height	ANCHO Width	PESO UNIDAD Weight unit	UNIDAD PALET Units pallet	BLANCO White	BLANCO HF HF White	GRIS HF HF Grey	TEXTIL HF HF Textile
450	600	9 kg.	24	7000674	7002727	7002636	7002558
	700	9.5 kg.	24	7001315	—	7002637	7002559
	900	11,5 kg.	24	7000676	7002726	7002638	7002560

CARACTERISTICAS / Features				CÓDIGO / Code			
ALTURA Height	ANCHO Width	PESO UNIDAD Weight unit	UNIDAD PALET Units pallet	BLANCO White	BLANCO HF HF White	GRIS HF HF Grey	TEXTIL HF HF Textile
560	600	10 kg.	24	—	7002728	—	—

CARACTERISTICAS / Features				CÓDIGO / Code			
ALTURA Height	ANCHO Width	PESO UNIDAD Weight unit	UNIDAD PALET Units pallet	BLANCO White	BLANCO HF HF White	GRIS HF HF Grey	TEXTIL HF HF Textile
600	600	10,5 kg.	24	7000681	7002747	7002639	7002561

■ **CONDICIONES DE SUMINISTRO:**

- Palet completo.
- Por unidad, consultar condiciones.

■ **PURCHASING CONDITIONS:**

- Full pallet.
- Per unit, ask about conditions

COLUMNA DESPENSA, PROFUNDIDAD 580 mm.

Tall storage unit, depth 580 mm.

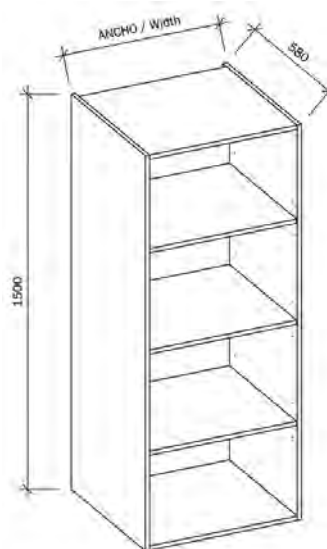
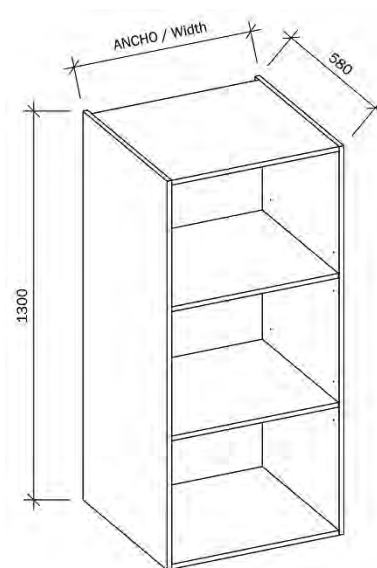
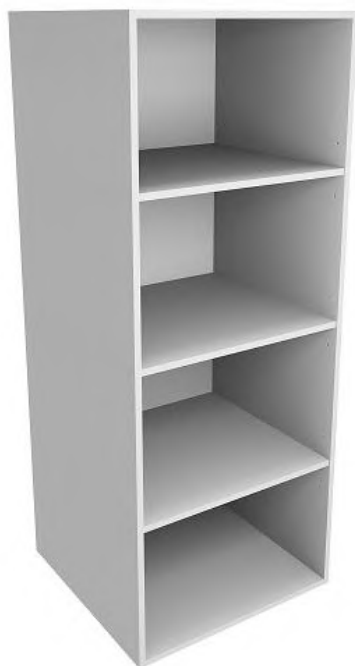

CARACTERISTICAS / Features				CÓDIGO / Code			
ALTURA Height	ANCHO Width	PESO UNIDAD Weight unit	UNIDAD PALET Units pallet	BLANCO White	BLANCO HF HF White	GRIS HF HF Grey	TEXTIL HF HF Textile
1300	600	34 kg.	10	7000993	—	7002667	7002589

CARACTERISTICAS / Features				CÓDIGO / Code			
ALTURA Height	ANCHO Width	PESO UNIDAD Weight unit	UNIDAD PALET Units pallet	BLANCO White	BLANCO HF HF White	GRIS HF HF Grey	TEXTIL HF HF Textile
1500	600	40 kg.	10	7002248	—	7002669	7002592

CONDICIONES DE SUMINISTRO:

- Palet completo.
- Por unidad, consultar condiciones.

PURCHASING CONDITIONS:

- Full pallet.
- Per unit, ask about conditions

COLUMNA DESPENSA, PROFUNDIDAD 580 mm.

Tall storage unit, depth 580 mm.

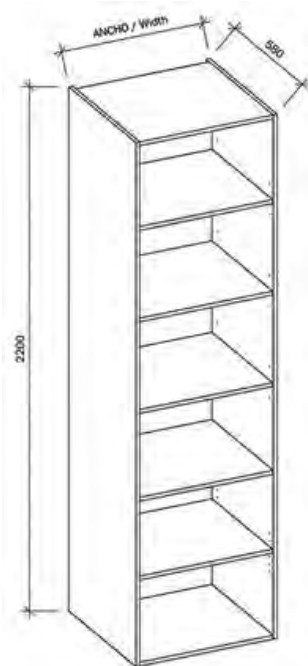
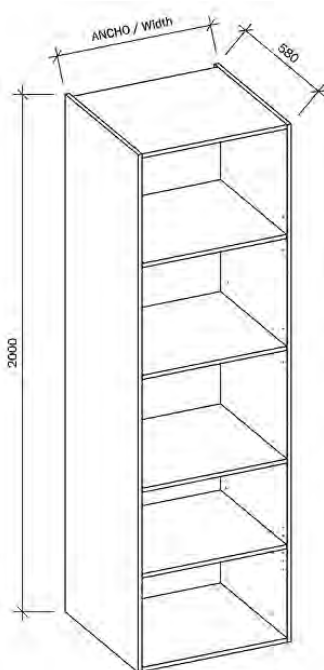
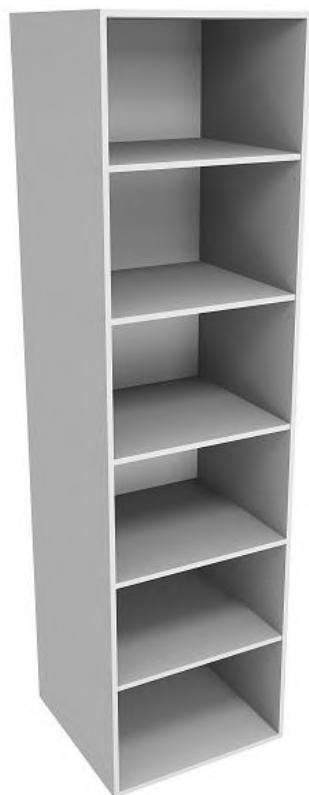

CARACTERISTICAS / Features				CÓDIGO / Code			
ALTURA Height	ANCHO Width	PESO UNIDAD Weight unit	UNIDAD PALET Units pallet	BLANCO White	BLANCO HF HF White	GRIS HF HF Grey	TEXTIL HF HF Textile
2000	400	42 kg.	10	7001041	7002741	7002659	7002581
	450	44 kg.	10	7001043	—	7002660	7002582
	600	49 kg.	10	7001045	7002742	7002661	7002583

CARACTERISTICAS / Features				CÓDIGO / Code			
ALTURA Height	ANCHO Width	PESO UNIDAD Weight unit	UNIDAD PALET Units pallet	BLANCO White	BLANCO HF HF White	GRIS HF HF Grey	TEXTIL HF HF Textile
2200	400	46 kg.	10	7001058	7002743	7002662	7002584
	450	49 kg.	10	7001060	—	7002663	7002585
	600	57 kg.	10	7001062	7002744	7002664	7002586

■ **CONDICIONES DE SUMINISTRO:**

- Palet completo.
- Por unidad, consultar condiciones.

■ **PURCHASING CONDITIONS:**

- Full pallet.
- Per unit, ask about conditions

COLUMNA HORNO-MICROONDAS, PROFUNDIDAD 580 mm.

Tall oven housing-micro unit, depth 580 mm.

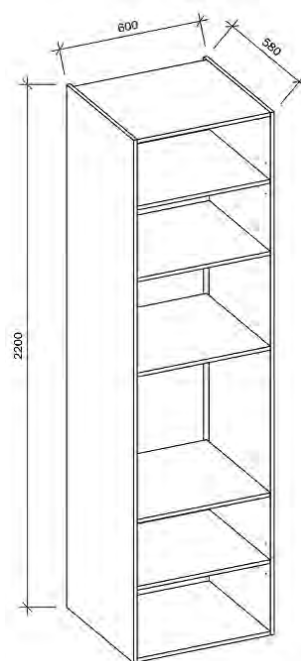
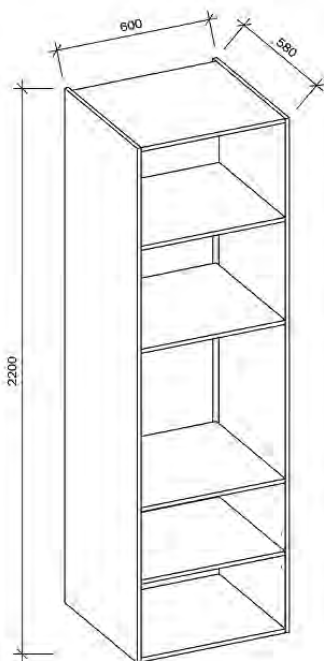
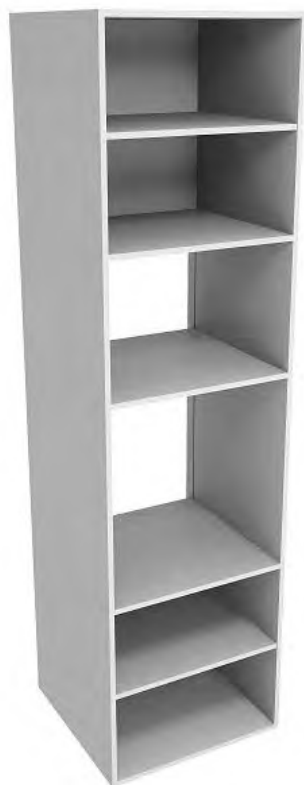

CARACTERISTICAS / Features				CÓDIGO / Code			
ALTURA Height	ANCHO Width	PESO UNIDAD Weight unit	UNIDAD PALET Units pallet	BLANCO White	BLANCO HF HF White	GRIS HF HF Grey	TEXTIL HF HF Textile
2000	600	49 kg.	10	7001321	—	—	—

CARACTERISTICAS / Features				CÓDIGO / Code			
ALTURA Height	ANCHO Width	PESO UNIDAD Weight unit	UNIDAD PALET Units pallet	BLANCO White	BLANCO HF HF White	GRIS HF HF Grey	TEXTIL HF HF Textile
2200	600	57 kg.	10	7001323	—	—	—

CONDICIONES DE SUMINISTRO:

- Palet completo.
- Por unidad, consultar condiciones.

PURCHASING CONDITIONS:

- Full pallet.
- Per unit, ask about conditions

B.

COMPLEMENTOS PARA MODULOS

Supplements for cabinets

**TOP FORM**

BANDA CANTEADA CON CANAL A 19 mm.

19 mm to edged board with groove

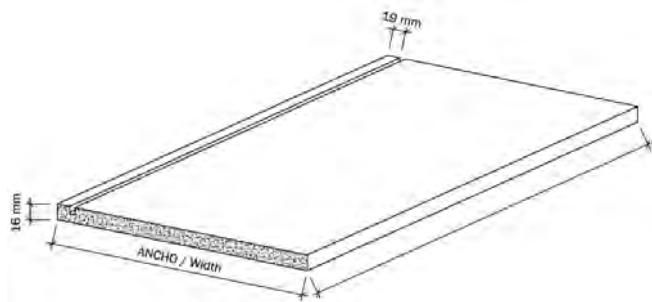
■ CARACTERISTICAS TECNICAS:**Terminación:** canteado con canal.**Soporte:** tablero aglomerado 16 mm grosor con melamina decorativa MFC.**Adhesivo:** resina melamínica.**■ FEATURES:****Finish edged:** with groove.**Base:** thick particle board 16 mm thick with decorative MFC melamine.**Adhesive:** melamine resin.

ACABADO Finish	ANCHO Width	LARGO Lenght	PESO UNIDAD Weight unit	PAQUETE Package	CÓDIGO Code
BLANCO / White	330	2850	10 kg,	50	8900012
BLANCO HF / White	330	3660	12,8 kg,	15	8900548
GRIS HF / Grey	330	2850	10 kg,	15	8900495
TEXTIL HF / Textile	330	2850	10 kg,	15	8900496

■ CONDICIONES DE SUMINISTRO:

- Paquete estándar por medida y color (ver tabla).
- Por unidad, consultar condiciones.

■ PURCHASING CONDITIONS:

- Standard package per measurement and colour (see table).
- Per unit, ask about conditions

BANDA CANTEADA CON CANAL A 45 mm.

45 mm to edged board with groove

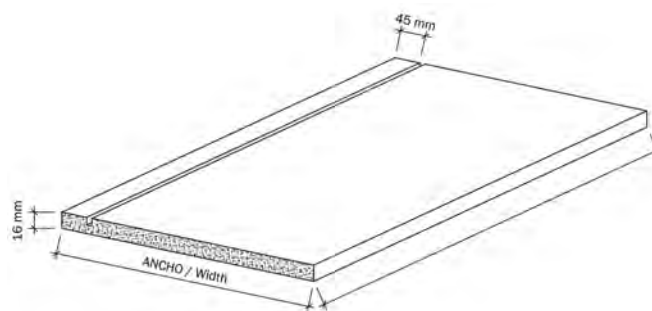
■ CARACTERISTICAS TECNICAS:**Terminación:** canteado con canal.**Soporte:** tablero aglomerado 16 mm grosor con melamina decorativa MFC.**Adhesivo:** resina melamínica.**■ FEATURES:****Finish edged:** with groove.**Base:** thick particle board 16 mm thick with decorative MFC melamine.**Adhesive:** melamine resin.

ACABADO Finish	ANCHO Width	LARGO Lenght	PESO UNIDAD Weight unit	PAQUETE Package	CÓDIGO Code
BLANCO / White	580	2850	17,5 kg	50	8900017
BLANCO HF / White	580	3660	22,5 kg	15	8900549
GRIS HF / Grey	580	2850	17,5 kg	15	8900506
TEXTIL HF / Textile	580	2850	17,5 kg	15	8900497

■ CONDICIONES DE SUMINISTRO:

- Paquete estándar por medida y color (ver tabla).
- Por unidad, consultar condiciones.

■ PURCHASING CONDITIONS:

- Standard package per measurement and colour (see table).
- Per unit, ask about conditions

BANDA CANTEADA SIN CANAL

Edged board without groove

■ CARACTERISTICAS TECNICAS:

Terminación: canteado con canal.

Soporte: tablero aglomerado 16 mm grosor con melamina decorativa MFC.

Adhesivo: resina melamínica.

■ FEATURES:

Finish edged: with groove.

Base: thick particle board 16 mm thick with decorative MFC melamine.

Adhesive: melamine resin.

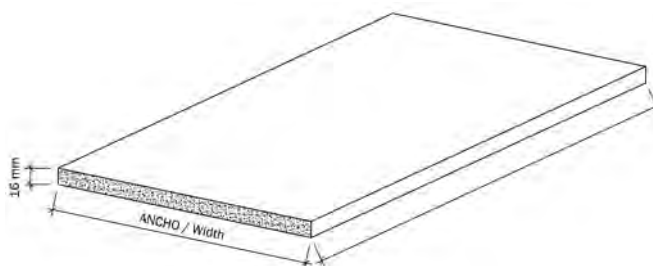

ACABADO Finish	ANCHO Width	LARGO Lenght	PESO UNIDAD Weight unit	PAQUETE Package	CÓDIGO Code
BLANCO / White	300	2850	9,5 kg.	50	8900022
	330	2850	10 kg.	50	8900023
	510	2850	15,5 kg.	50	8900030
	580	2850	17,5 kg.	50	8900036
	600	2850	18,5 kg.	50	8900037
BLANCO HF / White	300	3660	12 kg.	15	8900550
	330	3660	12,8 kg.	15	8900551
	510	3660	20 kg.	15	8900552
	580	3660	22,5 kg.	15	8900553
	600	3660	23,8 kg.	15	8900554
GRIS HF / Grey	300	2850	9,5 kg.	15	8900502
	330	2850	10 kg.	15	8900503
	510	2850	15,5 kg.	15	8900504
	580	2850	17,5 kg.	15	8900494
	600	2850	18,5 kg.	15	8900505
TEXTIL HF / Textile	300	2850	9,5 kg.	15	8900498
	330	2850	10 kg.	15	8900499
	510	2850	15,5 kg.	15	8900508
	580	2850	17,5 kg.	15	8900500
	600	2850	18,5 kg.	15	8900501

■ CONDICIONES DE SUMINISTRO:

- Paquete estándar por medida y color (ver tabla).
- Por unidad, consultar condiciones.

■ PURCHASING CONDITIONS:

- Standard package per measurement and colour (see table).
- Per unit, ask about conditions

CANTOS POLILAMINADOS / Polilaminated edgebanding

ACABADO Finish	ANCHO Width	LARGO Lenght	PAQUETE Package	CÓDIGO Code
BLANCO / White	19 mm	0,4 mm	820 ml.	9600061
	19 mm	0,8 mm	320 ml.	9600050
BLANCO HF / White	19 mm	0,4 mm	820 ml.	9600061
	19 mm	0,8 mm	320 ml.	9600050
GRIS HF / Grey	19 mm	0,4 mm	820 ml.	9600495
	19 mm	0,8 mm	320 ml.	9600496
TEXTIL HF / Textile	19 mm	0,4 mm	820 ml.	9600982
	19 mm	0,8 mm	320 ml.	9600983

■ CONDICIONES DE SUMINISTRO:

- Paquete estándar por medida y color (ver tabla).
- Por unidad, consultar condiciones.

■ PURCHASING CONDITIONS:

- Standard package per measurement and colour (see table).
- Per unit, ask about conditions

TABLERO MFC

MFC board

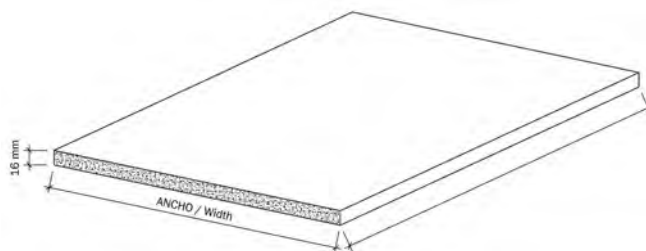
■ CARACTERISTICAS TECNICAS:**Soporte:** tablero aglomerado 16 mm grosor con melamina decorativa MFC..**Adhesivo:** resina melamínica.**■ FEATURES:****Base:** thick particle board 16 mm thick with decorative MFC melamine.**Adhesive:** melamine resin.

ACABADO Finish	LARGO Lenght	ANCHO Width	PESO UNIDAD Weight unit	PAQUETE Package	CÓDIGO Code
BLANCO / White	3660	2120	84,5 kg.	10	9301860
BLANCO HF / White	3660	2120	84,5 kg.	10	9300849
GRIS HF / Grey	2850	2120	65,5 kg.	10	9302456
TEXTIL HF / Textile	2850	2440	75,5 kg.	10	9302457

■ CONDICIONES DE SUMINISTRO:

- Paquete estándar por medida y color (ver tabla).
- Por unidad, consultar condiciones.

■ PURCHASING CONDITIONS:

- Standard package per measurement and colour (see table).
- Per unit, ask about conditions

TRASERA MFC

MFC back panel

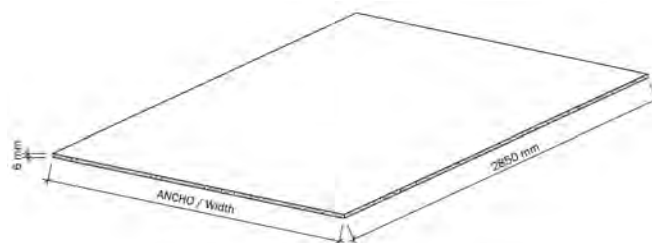
■ CARACTERISTICAS TECNICAS:**Soporte:** tablero aglomerado 6 mm grosor con melamina decorativa MFC.**Adhesivo:** resina melamínica.**■ FEATURES:****Base:** thick particle board 6 mm thick with decorative MFC melamine.**Adhesive:** melamine resin.

ACABADO Finish	LARGO Lenght	ANCHO Width	PESO UNIDAD Weight unit	PAQUETE Package	CÓDIGO Code
BLANCO / White	2850	1050	12 kg.	20	9300014
BLANCO HF / White	3660	1030	15,4 kg.	20	9302883
GRIS HF / Grey	2850	1050	12 kg.	20	9300359
TEXTIL HF / Textile	2850	1050	12 kg.	20	9301701

■ CONDICIONES DE SUMINISTRO:

- Paquete estándar por medida y color (ver tabla).
- Por unidad, consultar condiciones.

■ PURCHASING CONDITIONS:

- Standard package per measurement and colour (see table).
- Per unit, ask about conditions

6.

HERRAJES Y ACCESORIOS

Kitchen Wardware



TOP FORM

A.

TIRADORES

Handles



TOP FORM

ASAS | Handles

ALCOCER

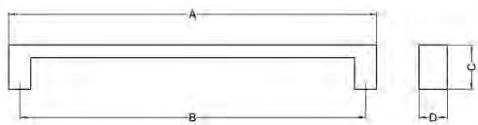

COTAS EN mm.				ACABADO Finish	CÓDIGO Code
A	B	C	D		
234	225	28	228	Cromo brillo	9900192
234	225	28	228	Inox.	9900193



AMBERES

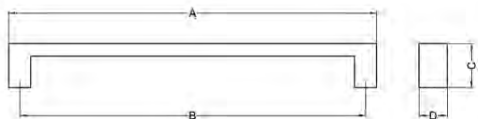

COTAS EN mm.				ACABADO Finish	CÓDIGO Code
A	B	C	D		
129	96	29	26	Peltre	9908666



BAYONA

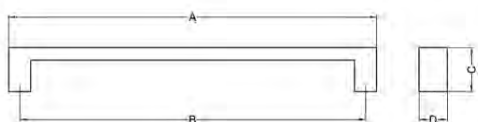

COTAS EN mm.				ACABADO Finish	CÓDIGO Code
A	B	C	D		
223	192	36	20	Niquel cepillado	9908672
223	192	36	20	Cromo brillo	9908673



BELAGUA

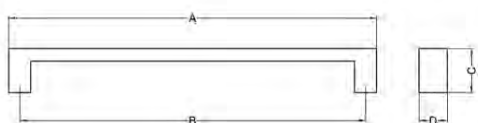

COTAS EN mm.				ACABADO Finish	CÓDIGO Code
A	B	C	D		
147	128	35	14	Aluminio	9900196
211	192	35	14	Aluminio	9900197



ASAS | Handles

BERNA

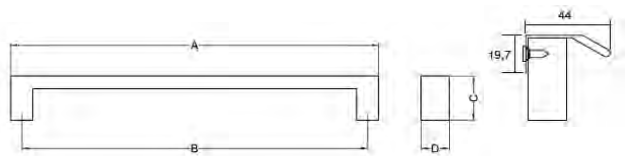

COTAS EN mm.				ACABADO Finish	CÓDIGO Code
A	B	C	D		
200	128	20	44	Negro mate	9908663
200	128	20	44	Inox look	9908664



DUBLÍN

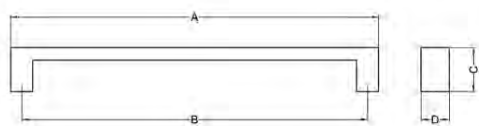

COTAS EN mm.				ACABADO Finish	CÓDIGO Code
A	B	C	D		
201	192	32	15	Peltre	9910716
201	192	32	15	Latón antiguo	9910717



ESTOCOLMO

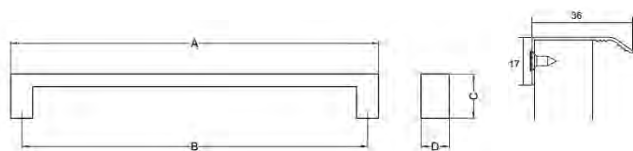

COTAS EN mm.				ACABADO Finish	CÓDIGO Code
A	B	C	D		
200	128	17	36	Blanco	9905025
200	128	17	36	Negro	9905026
200	128	17	36	Inox look	9905027
300	192	17	36	Inox look	9905028



GARVÍN

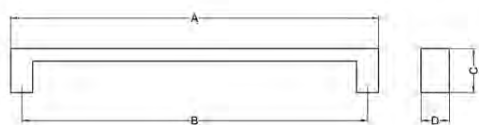

COTAS EN mm.				ACABADO Finish	CÓDIGO Code
A	B	C	D		
136	128	24	12	Cromo mate	9900194



ASAS | Handles

LAYOS

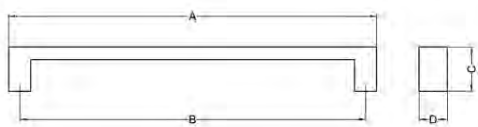

COTAS EN mm.				ACABADO Finish	CÓDIGO Code
A	B	C	D		
155	128	25	16	Niquel mate	9900179



MARSELLA

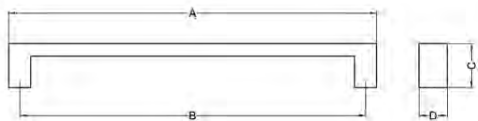

COTAS EN mm.				ACABADO Finish	CÓDIGO Code
A	B	C	D		
207	192	30	14	Niquel cepillado	9908671



MIJARES

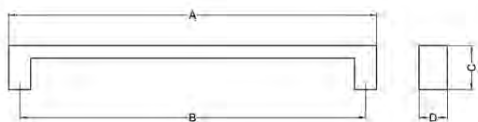

COTAS EN mm.				ACABADO Finish	CÓDIGO Code
A	B	C	D		
208	192	34	10	Cromo mate	9900185



NAPLES

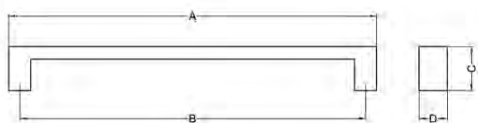

COTAS EN mm.				ACABADO Finish	CÓDIGO Code
A	B	C	D		
298	224	30	21	Niquel cepillado	9908671



ASAS | Handles

NOVES

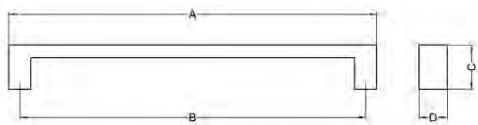

COTAS EN mm.				ACABADO Finish	CÓDIGO Code
A	B	C	D		
166	128	28	17	Cromo mate	9900175
166	128	28	17	Cromo brillo	9900176

OPORTO

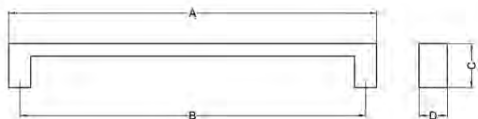

COTAS EN mm.				ACABADO Finish	CÓDIGO Code
A	B	C	D		
218	192	22	17	Negro-blanco	9908675
218	192	22	17	Gris-marrón	9908677

ORGAZ

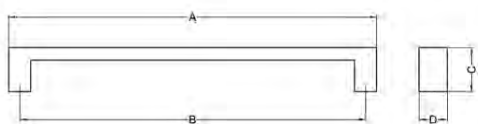

COTAS EN mm.				ACABADO Finish	CÓDIGO Code
A	B	C	D		
242	192	32	9	Aluminio	9900186

PRAGA

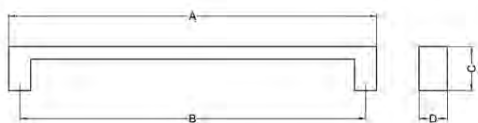

COTAS EN mm.				ACABADO Finish	CÓDIGO Code
A	B	C	D		
200	128	11	20	Blanco	9904164
200	128	11	20	Negro	9904165

ASAS | Handles

RONDÍN

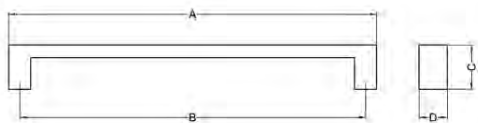

COTAS EN mm.				ACABADO Finish	CÓDIGO Code
A	B	C	D		
292	256	28	8	Cromo brillo	9900190
292	256	28	8	Inox	9900191



ROZAS

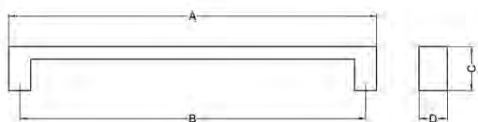

COTAS EN mm.				ACABADO Finish	CÓDIGO Code
A	B	C	D		
210	192	30	13	Niquel satinado	9900205
280	256	35	13	Niquel satinado	9900206



SAN MARINO

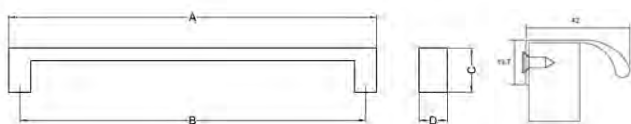

COTAS EN mm.				ACABADO Finish	CÓDIGO Code
A	B	C	D		
200	128	20	42	Inox look	9908665



SEGOVIA

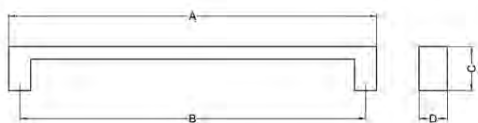

COTAS EN mm.				ACABADO Finish	CÓDIGO Code
A	B	C	D		
178	128	32	12	Inox	9900188
242	192	32	12	Inox	9900189



ASAS | *Handles*

SINTRA

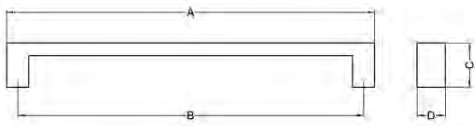

COTAS EN mm.				ACABADO <i>Finish</i>	CÓDIGO <i>Code</i>
A	B	C	D		
175	160	25	17	Peltre	9910714
175	160	25	17	Latón antiguo	9910715

SONSECA

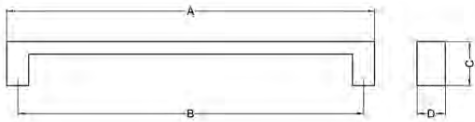

COTAS EN mm.				ACABADO <i>Finish</i>	CÓDIGO <i>Code</i>
A	B	C	D		
204	192	35	12	Inox cepillado	9902127

SORIA

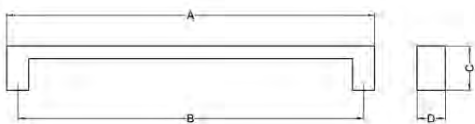

COTAS EN mm.				ACABADO <i>Finish</i>	CÓDIGO <i>Code</i>
A	B	C	D		
203	160	28	19	Niquel mate	9900240

TIETAR

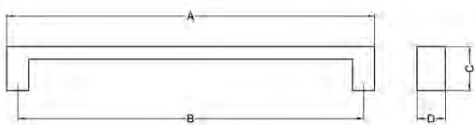

COTAS EN mm.				ACABADO <i>Finish</i>	CÓDIGO <i>Code</i>
A	B	C	D		
172	128	29	24	Cromo look	9900198
204	160	29	24	Cromo look	9900199

ASAS | Handles

TOLEDO

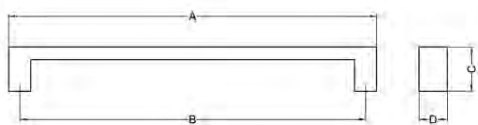

COTAS EN mm.				ACABADO Finish	CÓDIGO Code
A	B	C	D		
224	192	28	12	Peltre	9910712
224	192	28	12	Latón antiguo	9910713



VARSOVIA

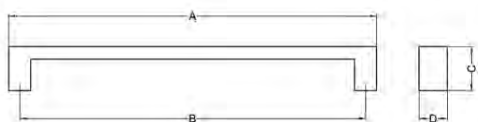

COTAS EN mm.				ACABADO Finish	CÓDIGO Code
A	B	C	D		
97	64	34,5	19	Negro mate	9908667
97	64	34,5	19	Plata antigua	9908668
97	64	34,5	19	Cobre antiguo	9908669



VILNA

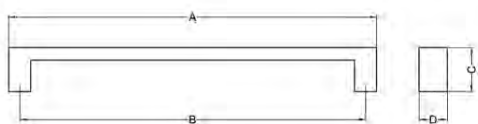

COTAS EN mm.				ACABADO Finish	CÓDIGO Code
A	B	C	D		
221	192	28	7	Cromo brillo	9908752
221	192	28	7	Niquel satinado	9908753



YEBENES

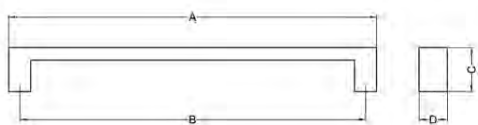

COTAS EN mm.				ACABADO Finish	CÓDIGO Code
A	B	C	D		
192	160	29	21	Cromo mate	9900184



POMOS | Knobs

ALMANSA

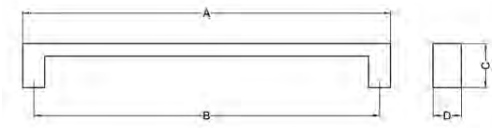

COTAS EN mm.				ACABADO Finish	CÓDIGO Code
A	B	C	D		
10	∅	20	10	Cromo mate	9900260

ONDA

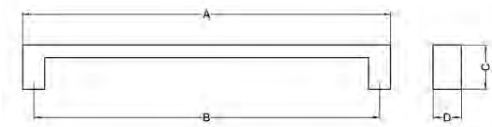

COTAS EN mm.				ACABADO Finish	CÓDIGO Code
A	B	C	D		
30	∅	25	30	Cromo mate	9900261

OPORTO

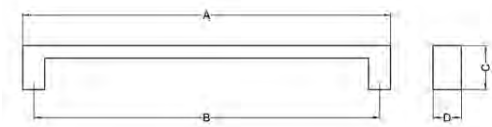

COTAS EN mm.				ACABADO Finish	CÓDIGO Code
A	B	C	D		
42	16	22	17	Negro-blanco	9908674
42	16	22	17	Gris-marrón	9908676

TOLEDO

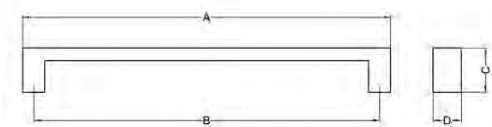

COTAS EN mm.				ACABADO Finish	CÓDIGO Code
A	B	C	D		
31	∅	21	15	Peltre	9910710
31	∅	21	15	Latón antiguo	9910711

INTEGRADOS | Integrated

ALTAMIRA

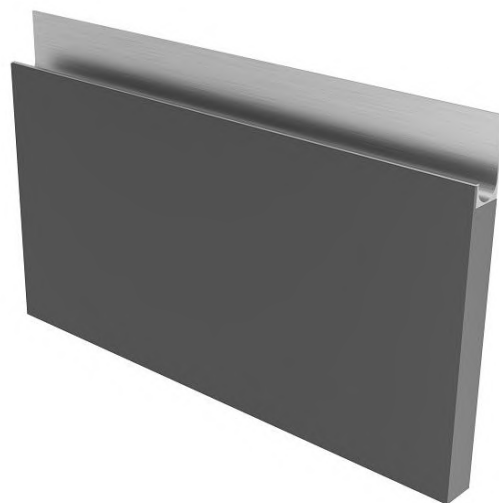
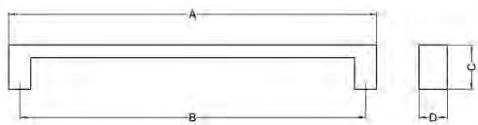

COTAS EN mm.				ACABADO <i>Finish</i>	CÓDIGO <i>Code</i>
A	B	C	D		
3000	—	35	16	Inox	9903078
3000	—	35	16	Aluminio mate	9902902
3000	—	35	16	Blanco	9908025

SAONA

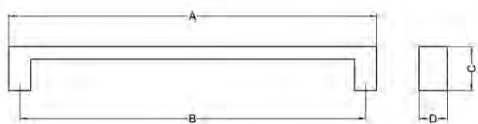

COTAS EN mm.				ACABADO <i>Finish</i>	CÓDIGO <i>Code</i>
A	B	C	D		
3000	—	2	19	Inox look	9910701
3000	—	2	22	Inox look	9910702

VENECIA

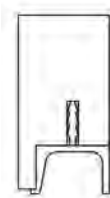
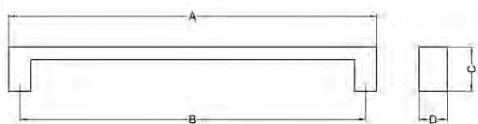

COTAS EN mm.				ACABADO <i>Finish</i>	CÓDIGO <i>Code</i>
A	B	C	D		
3000	—	35	16	Inox	9904934
3000	—	35	16	Aluminio mate	9904933
3000	—	35	16	Blanco	9905419

INTEGRADOS | *Integrated*

BRUJAS

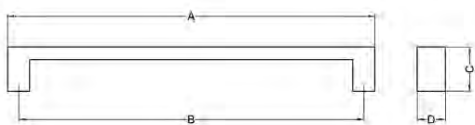

COTAS EN mm.				ACABADO <i>Finish</i>	CÓDIGO <i>Code</i>
A	B	C	D		
147	—	2	19	Inox look	9908678
197	—	2	19	Inox look	9908679
247	—	2	19	Inox look	9908680
277	—	2	19	Inox look	9908782
297	—	2	19	Inox look	9908681
327	—	2	19	Inox look	9908784
347	—	2	19	Inox look	9908682
397	—	2	19	Inox look	9908683
447	—	2	19	Inox look	9908684
497	—	2	19	Inox look	9908685
597	—	2	19	Inox look	9908686
697	—	2	19	Inox look	9908687
797	—	2	19	Inox look	9908688
897	—	2	19	Inox look	9908689
997	—	2	19	Inox look	9908690
1197	—	2	19	Inox look	9908691
147	—	2	21	Inox look	9908692
197	—	2	21	Inox look	9908693
247	—	2	21	Inox look	9908694
277	—	2	21	Inox look	9908783
297	—	2	21	Inox look	9908695
327	—	2	21	Inox look	9908785
347	—	2	21	Inox look	9908696
397	—	2	21	Inox look	9908697
447	—	2	21	Inox look	9908698
497	—	2	21	Inox look	9908699
597	—	2	21	Inox look	9908700
697	—	2	21	Inox look	9908701
797	—	2	21	Inox look	9908702
897	—	2	21	Inox look	9908703
997	—	2	21	Inox look	9908704
1197	—	2	21	Inox look	9908705

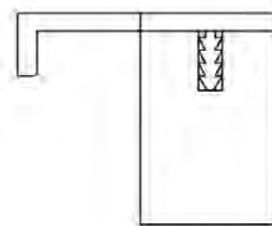

INTEGRADOS | Integrated

LISBOA

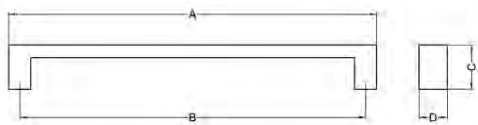

COTAS EN mm.				ACABADO Finish	CÓDIGO Code
A	B	C	D		
147	—	2	19	Inox look	9905038
197	—	2	19	Inox look	9905984
247	—	2	19	Inox look	9905039
297	—	2	19	Inox look	9905040
347	—	2	19	Inox look	9905041
397	—	2	19	Inox look	9905042
447	—	2	19	Inox look	9905043
497	—	2	19	Inox look	9905044
597	—	2	19	Inox look	9905045
697	—	2	19	Inox look	9905046
797	—	2	19	Inox look	9905047
897	—	2	19	Inox look	9905048
997	—	2	19	Inox look	9905985
1197	—	2	19	Inox look	9905037
997	—	2	19	Inox look	9908690
1197	—	2	19	Inox look	9908691
147	—	2	21	Inox look	9905050
197	—	2	21	Inox look	9906963
247	—	2	21	Inox look	9905051
297	—	2	21	Inox look	9905052
347	—	2	21	Inox look	9905053
397	—	2	21	Inox look	9905054
447	—	2	21	Inox look	9905055
497	—	2	21	Inox look	9905056
597	—	2	21	Inox look	9905057
697	—	2	21	Inox look	9905058
797	—	2	21	Inox look	9905059
897	—	2	21	Inox look	9905060
997	—	2	21	Inox look	9905987
1197	—	2	21	Inox look	9905049
997	—	2	21	Inox look	9908704
1197	—	2	21	Inox look	9908705

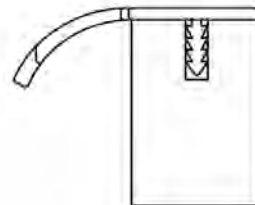

SISTEMA GOLA | *Gola system*

HERRAJES Y ACCESORIOS / Kitchen Wardware

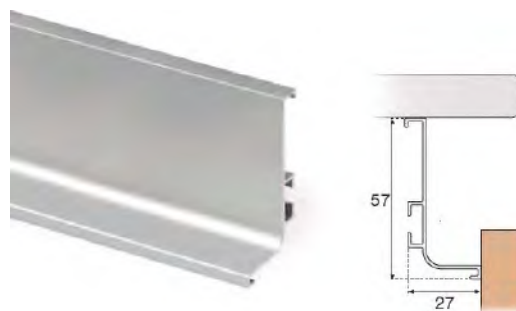

SISTEMA GOLA | *Gola system***PERFIL GOLA HORIZONTAL** / *Gola horizontal profile*

LONGITUD <i>Lenght</i>	ACABADO <i>Finish</i>	CÓDIGO <i>Code</i>
3950 mm	Plata mate	9910616
3950 mm	Blanco	9910627

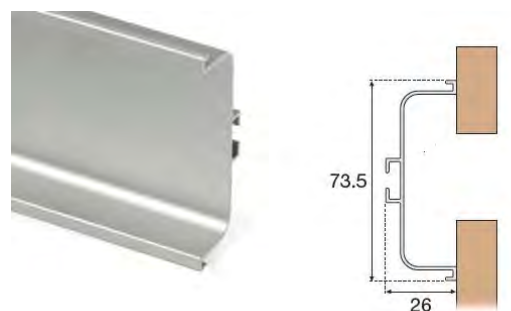
PERFIL GOLA HORIZONTAL CAJONES / *Gola horizontal profile for drawers*

LONGITUD <i>Lenght</i>	ACABADO <i>Finish</i>	CÓDIGO <i>Code</i>
3950 mm	Plata mate	9910617
3950 mm	Blanco	9910628

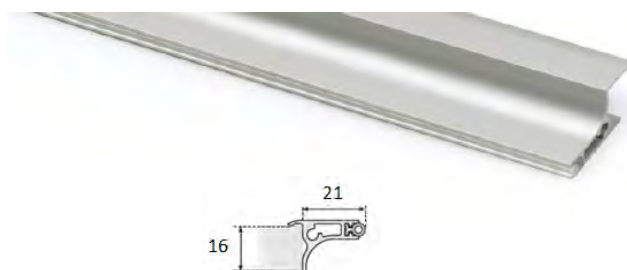
PERFIL GOLA INTERIOR / *Gola interior profile*

LONGITUD <i>Lenght</i>	ACABADO <i>Finish</i>	CÓDIGO <i>Code</i>
3950 mm	Plata mate	9910620
3950 mm	Blanco	9910631

SISTEMA GOLA | *Gola system*

PERFIL GOLA VERTICAL / *Gola vertical profile*

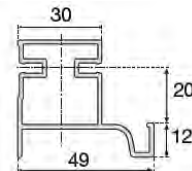

LONGITUD <i>Lenght</i>	ACABADO <i>Finish</i>	CÓDIGO <i>Code</i>
2350 mm	Plata mate	9910618
2350 mm	Blanco	9910629

PERFIL GOLA VERTICAL DOBLE / *Gola vertical double profile*

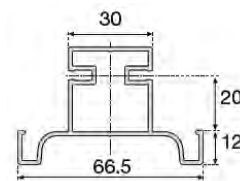

LONGITUD <i>Lenght</i>	ACABADO <i>Finish</i>	CÓDIGO <i>Code</i>
2350 mm	Plata mate	9910619
2350 mm	Blanco	9910630

SET SOPORTE FIJACIÓN PERFIL GOLA / *Gola profile fixing support set*



LONGITUD <i>Lenght</i>	ACABADO <i>Finish</i>	CÓDIGO <i>Code</i>
30x30 mm	Zincado	9910638

SISTEMA GOLA | *Gola system***SET TAPAS CERRADA PERFIL GOLA** / *Gola profile caps closed set*

PERFIL Profile	ACABADO Finish	CÓDIGO Code
Horizontal	Plata mate	9910621
Horizontal	Blanco	9910632
Cajones	Plata mate	9910622
Cajones	Blanco	9910633

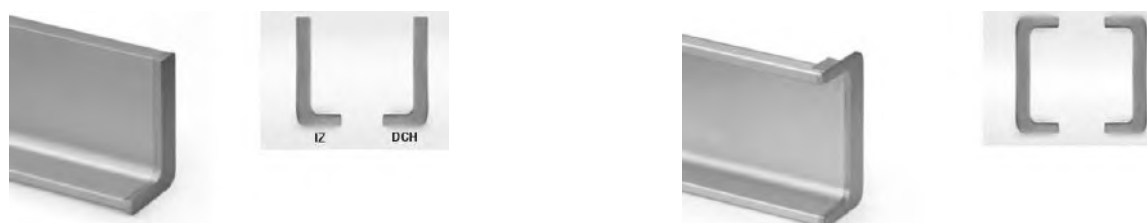
SET TAPAS ABIERTA PERFIL GOLA / *Gola profile caps open set*

PERFIL Profile	ACABADO Finish	CÓDIGO Code
Horizontal	Plata mate	9910623
Horizontal	Blanco	9910634
Cajones	Plata mate	9910624
Cajones	Blanco	9910635

RINCÓN PERFIL GOLA / *Gola profile outside corner*

PERFIL Profile	ACABADO Finish	CÓDIGO Code
Horizontal	Plata mate	9910625
Horizontal	Blanco	9910636

ESQUINA PERFIL GOLA / *Gola profile inside corner*

PERFIL Profile	ACABADO Finish	CÓDIGO Code
Horizontal	Plata mate	9910626
Horizontal	Blanco	9910637

B.

ACCESORIOS DE MONTAJE

Mounting accessories



TOP FORM

TIRAFONDOS PARA AGLOMERADO / Screws for chipboard**■ CARACTERÍSTICAS TÉCNICAS:**

Tirafondo para aglomerado con cabeza plana de ranura en cruz.
Ababado: zincado. Suministro por caja completa.

■ FEATURES:

Flat head, cross slot screws for chipboard.
Finish: zinc. Full box provision.

DESCRIPCIÓN Description	UD. CAJA Package	CÓDIGO Code
Tirafondo 3,5x15 mm / Screw 3,5x15 mm	1000 ud.	9901419
Tirafondo 3,5x17 mm / Screw 3,5x17 mm	1000 ud.	9901420
Tirafondo 3,5x30 mm / Screw 3,5x30 mm	1000 ud.	9901421
Tirafondo 3,5x40 mm / Screw 3,5x40 mm	1000 ud.	9901422
Tirafondo 4x16 mm / Screw 4x16 mm	1000 ud.	9901424
Tirafondo 4x30 mm / Screw 4x30 mm	200 ud.	9901425

**TORNILLOS PARA TIRADOR / Screws for handle****■ CARACTERÍSTICAS TÉCNICAS:**

Tornillo metrica 4 para tirador con cabeza de ranura en cruz.
Ababado: zincado. Suministro por caja completa.

■ FEATURES:

Metric 4 screw for handles with cross slot.
Finish: zinc. Full box provision.

DESCRIPCIÓN Description	UD. CAJA Package	CÓDIGO Code
Tornillo M4 22 mm / Screw M4 22 mm	500 ud.	9901428
Tornillo M4 25 mm / Screw M4 25 mm	500 ud.	9901429
Tornillo M4 30 mm / Screw M4 30 mm	500 ud.	9901430

**ESCUADRAS PARA UNION / Corner brackets****■ CARACTERÍSTICAS TÉCNICAS:**

Escuadra metalica cincada para ensamblaje. Grosor: 1,5 mm.

■ FEATURES:

Zinc metal bracket for assembly. Thickness: 1.5 mm.

DESCRIPCIÓN Description	CÓDIGO Code
Escuadra cincada 20x20x16 mm / Zinc bracket 20x20x16 mm	9901431
Escuadra cincada 28x28x16 mm / Zinc bracket 28x28x16 mm	9901432
Escuadra cincada 36x36x16 mm / Zinc bracket 36x36x16 mm	9901433

**ESCUADRA ABATIBLE / Collapsible framing square****■ CARACTERÍSTICAS TÉCNICAS:**

Escuadra metalica abatible mediante resortes, para estantes y mostradores.
Presentación: 300x300 mm y 400x400 mm. Acabado cromado.

■ FEATURES:

Spring-hinged collapsible framing square for shelves and counters.
Presentation: 300x300 mm. and 400x400 mm. Finish: Chrome.

DESCRIPCIÓN Description	CÓDIGO Code
Escuadra abatible 300x300 mm / Collapsible framing 300x300 mm	9901434
Escuadra abatible 400x400 mm / Collapsible framing 400x400 mm	9901435



TORNILLO ENSAMBLE 5x50 mm

Assembly screw 5x50 mm _____



ACABADO Finish	CÓDIGO Code
Zincado / Zinc	9700147

ESPIGA MADERA ESTRIADA 8x30 mm

8x30 mm grooved wooden dowel _____

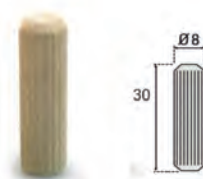

ACABADO Finish	CÓDIGO Code
Haya / Beech	9700148

TACO NYLON PARA BASES BISAGRAS

Nylon cap for hinges _____



ACABADO Finish	CÓDIGO Code
Blanco / White	9700159

SOPORTE PORTAESTANTE ANTIVUELCO

Anti-tip shelf bracket with bolt _____



ACABADO Finish	CÓDIGO Code
Metacrilato	9700149

SOPORTE Y CONECTOR BALDA PREMIUM

Premium support and shelf connector _____



ACABADO Finish	CÓDIGO Code
SopORTE	9903990
Conector	9903991

SOPORTE BALDA CRISTAL PEKI

Peki glass shelf support _____

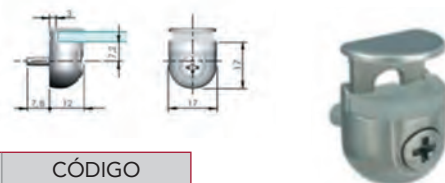

ACABADO Finish	CÓDIGO Code
Zincado / Zinc	9904303

TOPE EMBUTIDO AMORTIGUACION PUERTA

Door bumper by material _____



ACABADO Finish	CÓDIGO Code
Blanco / White	9700712

TOPE ADHESIVO AMORTIGUACION PUERTA

Adhesive doorstop _____



ACABADO Finish	CÓDIGO Code
Transparente	9900355

EMBELLECEDOR ADHESIVO PARA TORNILLO

Adhesive cap for screw _____



ACABADO Finish	CÓDIGO Code
Blanco / White	9900275
Gris / Grey	9900278

TAPON 25 mm PARA TALADRO COLGADOR

25 mm cap for hanging bracket hole _____



ACABADO Finish	CÓDIGO Code
Blanco / White	9700153
Gris / Grey	9700189
Metal / Metal	9904873

COLGADOR OCULTO TRASER-6 MONTAJE RAPIDO / Fast assembly traser-6 hidden hanging bracket**■ CARACTERÍSTICAS TÉCNICAS:**

Carga maxima por colgador 65 Kg según DIN68840.

La fijación se hace al costado del modulo, independientemente de la tapa superior.

Regulacion en profundidad: hasta 25 mm.

Regulacion en altura: hasta 18 mm.

■ FEATURES:

Maximum load per bracket: 65 kg in accordance with DIN68840.

Mounting is done on the side of the module, independently from the top cover.

Up to 25 mm. of adjustable depth.

Up to 18 mm. of adjustable height.

DESCRIPCIÓN Description	CÓDIGO Code
Colgador derecho / Right bracket	9901431
Colgador izquierdo / Left bracket	9901432
Enganche pared doble / Double wall hook	9901433

**SISTEMA SUSPENSION ATLAS / Atlas hanging system****■ CARACTERÍSTICAS TÉCNICAS:**

Sistema de fijación para módulos de cocina y baño a la pared que compensa la fuerza de palanca en los muebles suspendidos.

El sistema no interfiere en el funcionamiento de cajones. Acero cincado.

Regulación frontal: hasta 16 mm.

Regulación vertical: hasta 10 mm.

■ FEATURES:

System for mounting short kitchen and bathroom to the wall using the leverage of suspended units.

This system does not interfere with the use of drawers. Galvanised steel.

Front adjustability of up to 16 mm.

Vertical adjustability of up to 10 mm.

DESCRIPCIÓN Description	CÓDIGO Code
Enganche superior / Top hook	9903264
Soporte inferior / Lower bracket	9903267
Soporte superior simple / Single top bracket	9903265
Soporte superior doble / Double top bracket	9903266



Enganche superior
Top hook



Enganche inferior
Lower bracket



Enganche superior
Single top bracket



Enganche superior doble
Double top bracket

SOPORTE ALUMINIO PARA CIERRE MODULO / Aluminium bracket end module**■ CARACTERÍSTICAS TÉCNICAS:**

Barra soporte para refuerzo en módulos fregaderos y hornos.

Acabado en plata mate estriada. Soportes en acabado gris.

■ FEATURES:

Support rod for reinforcing units. Especially suitable for sinks and ovens.

Striated matte silver finish. Supports in grey finish.

DESCRIPCIÓN Description	CÓDIGO Code
Soporte módulo 450 mm / Module 450 mm	9901431
Soporte módulo 500 mm / Module 500 mm	9901431
Soporte módulo 600 mm / Module 600 mm	9901431
Soporte módulo 700 mm / Module 700 mm	9901431
Soporte módulo 800 mm / Module 800 mm	9901431
Soporte módulo 900 mm / Module 800 mm	9901431
Soporte módulo 1000 mm / Module 1000 mm	9901431
Barra soporte tira 4000 mm / Support rod 4000 mm	9901431
Soporte con tetón / Bracket with alignment pin	9901432
Soporte sin tetón / Bracket without alignment pin	9901433

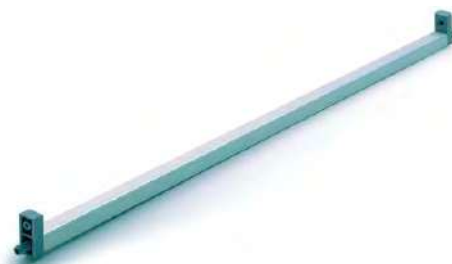
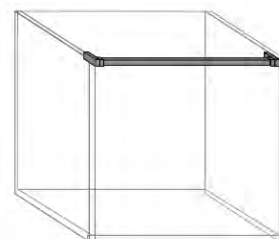

PATAS EXPANSIVAS PARA MODULOS DE BASE / Expandable legs for floor units

■ CARACTERÍSTICAS TÉCNICAS:

Presentación en bolsa de 4 unidades.
 Color negro con espiga de Ø 13 mm. Con regulaciones de 102>132 mm y 132>200 mm.
 Resistencia de la Estructura UNE 11016:89.
 Resistencia de los planos de trabajo UNE EN 1153:96.
 Resistencia al arrastre UNE 11023-2: 92.

■ FEATURES:

Come in bags of 4 pieces.
 Black with peg measuring 13 mm diameter. Adjusts from 102>132 mm and 132>200 mm.
 Structural strength complies with UNE 11016:89
 Work surface strength complies with UNE EN 1153:96
 Unit dragging complies with UNE 11023-2:92.

DESCRIPCIÓN Description	CÓDIGO Code
Patas regulación 102-132 mm / Adjustable 102-132 mm	9902914
Patas regulación 132-200 mm / Adjustable 132-200 mm	9900282



PATAS REFORZADAS PARA MODULOS DE BASE / Reinforced legs for floor units

■ CARACTERÍSTICAS TÉCNICAS:

Presentación en bolsa de 4 unidades. Soporte en A.B.S.
 Color negro con espiga de Ø 13 mm. Con regulaciones de 102>132 mm y 132>200 mm.
 Mayor longitud del soporte sobre la base del modulo.
 Fácil regulación con cargas elevadas y el lugares difíciles debido a su gran pie de regulación.

■ FEATURES:

Come in bags of 4 pieces. Bracket made of ABS.
 Black with peg measuring 13 mm diameter. Adjusts from 102>132 mm and 132>200 mm.
 Support cover more area on the base of the unit.
 Easily adjustable with heavy loads and difficult places thanks to its large adjustable foot.

DESCRIPCIÓN Description	CÓDIGO Code
Pata A.B.S. regulación 100-130 mm / Adjustable 100-130 mm	9903805
Pata A.B.S. regulación 132-200 mm / Adjustable 132-200 mm	9900283

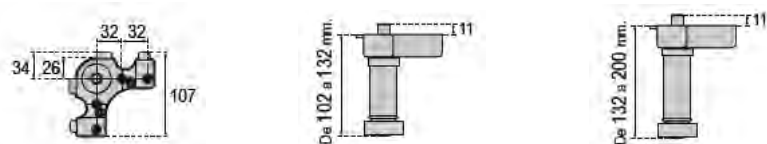

BISAGRAS DE CAZOLETA DE MONTAJE RAPIDO INTERMAT y SENSYS

Intermat and Sensys fast assembly cup hinges

■ CARACTERÍSTICAS TÉCNICAS:

Número de bisagras por puerta:

La anchura, altura y el peso de la puerta así como la calidad del material de la misma son factores decisivos para el número necesario de bisagras. Los factores que se presentan en la práctica son muy diferentes según el caso. Por ello, el número de bisagras indicado en la figura debe entenderse solo como valor de orientación. En caso de duda, es aconsejable efectuar una prueba o aumentar el número de bisagras. Por motivos de estabilidad se debe fijar la mayor distancia **X** posible entre las bisagras.

La distancia **X** será como mínimo de 280 mm.

■ FEATURES:

Number of hinges per door:

The width, height and weight of the door and the quality of the same material are factors for the necessary number of hinges. The factor that are in practice very different as applicable. Therefore, the number of hinges shown in the is meant only as a value of orientation. If in doubt, it is advisable to perform a test or to increase the number of hinges. For reasons of stability should be set as far away **X** possible between the hinges.

The **X** distance shall be at least 280 mm.

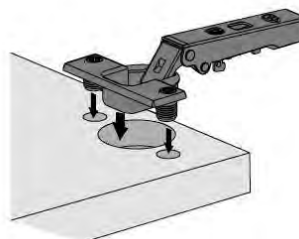
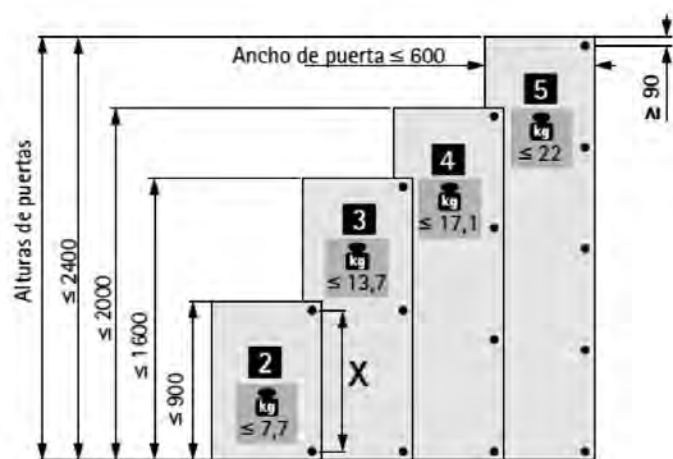

T43/TH-53 montaje directo
T43/TH-53 press-in assembly

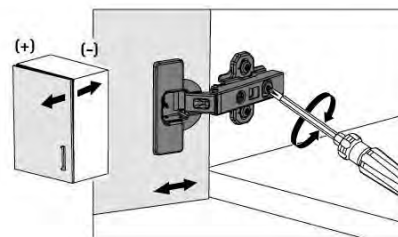

Ajuste de profundidad
Depth adjustment

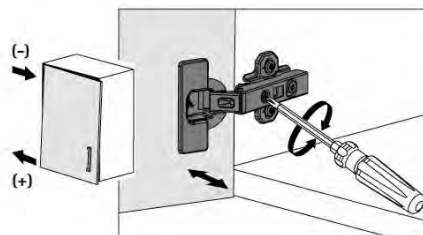

Ajuste de solapadura
Side adjustment

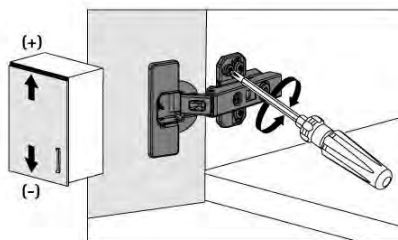

Ajuste de altura
Height adjustment

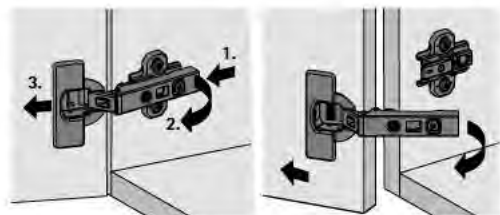

Montaje
Assembly

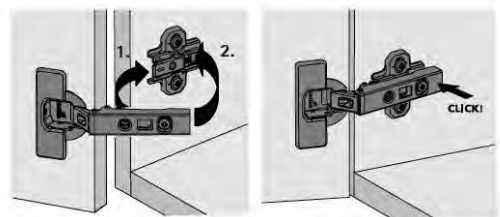

Desmontaje
Disassembly

BISAGRA DE MONTAJE RAPIDO INTERMAT 110°

Fast assembly 110° Intermat hinge

■ CARACTERÍSTICAS TÉCNICAS:

Bisagra automática con montaje por clip. Con cierre automático.
 Para grosores de puerta a partir de 16 mm. Diámetro de cazoleta 35 mm.
 Ajuste de solapadura integrado + 1,0 mm / - 2,5 mm.
 Ajuste de profundidad por excéntrica integrado ± 2 mm.
 Ajuste de altura mediante suplemento ± 2 mm.

■ FEATURES:

Snap-on hinge using clip. For doors at least 16 mm. thick.
 Cup diameter 35 mm. Automatic closure.
 Integrated horizontal position adjustment + 1,0 mm./- 2,5 mm.
 Integrated depth adjustment for eccentric hinges ± 2 mm.
 Height adjustment using wing mounting plate ± 2 mm.
 Hinge cup/arm made of nickel steel.

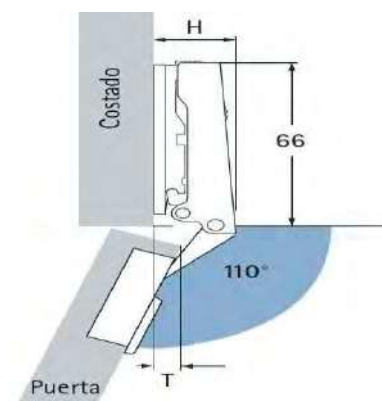

DESCRIPCIÓN Description	CÓDIGO Code
Bisagra Intermat 110° T43 / 110° T43 Intermat hinge	9900304

BISAGRA DE MONTAJE RAPIDO INTERMAT 165°

Fast assembly 165° Intermat hinge

■ CARACTERÍSTICAS TÉCNICAS:

Bisagra automática con montaje por clip. Con cierre automático.
 Para grosores de puerta a partir de 16 mm. Diámetro de cazoleta 35 mm.
 Ningún resalte de puerta, espacio interior libre para cajones. El Angulo de la puerta se puede reducir en continuo hasta 120° mediante el tornillo de ajuste.
 Ajuste de solapadura integrado + 1,0 mm/- 2,5 mm.
 Ajuste de profundidad por excéntrica integrado + 1,7 mm/- 2,3 mm
 Ajuste de altura mediante suplemento ± 2 mm.
 Cazoleta/brazo de bisagra: acero niquelado.

■ FEATURES:

Snap-on hinge using clip. For doors at least 16 mm. thick.
 Cup diameter 35 mm. Automatic closure.
 No overlay inside space free for drawers. Opening angle can be adjusted to any size up to 120° using the adjustment screw.
 Integrated side adjustment + 1.0 mm / - 2.5 mm.
 Integrated depth adjustment for eccenric hinges + 1,7 mm./2,3 mm.
 Height adjustment using wing mounting plate ± 2 mm.
 Hinge cup/arm made of nickel steel.

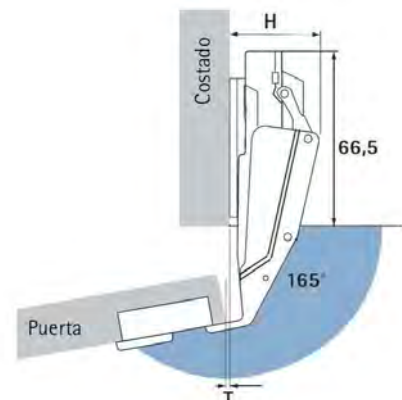

DESCRIPCIÓN Description	CÓDIGO Code
Bisagra Intermat 165° T43 / 165° T43 Intermat hinge	9900312

BISAGRA DE MONTAJE RAPIDO INTERMAT 45°

Fast assembly 45° Intermat hinge

■ CARACTERÍSTICAS TÉCNICAS:

Bisagra automática con montaje por clip. Con cierre automático.
 Para grosores de puerta a partir de 16 mm. Diámetro de cazoleta 35 mm.
 Ajuste de solapadura integrado + 2 mm/- 2,5 mm.
 Ajuste de profundidad por excéntrica integrado + 3,5 mm/- 0,5 mm.
 Ajuste de altura mediante suplemento ± 2 mm.
 Cazoleta de bisagra: acero niquelado.
 Brazo de bisagra: zamak niquelado.

■ FEATURES:

Snap-on hinge using clip. For doors at least 16 mm. thick.
 Cup diameter 35 mm. Automatic closure.
 Integrated side adjustment of + 2 mm./-2.5 mm.
 Integrated depth adjustment for eccentric hinges +3,5 mm./-0.5 mm.
 Hinge cup made of nickel steel.
 Hinge arm made of nickel zamak.

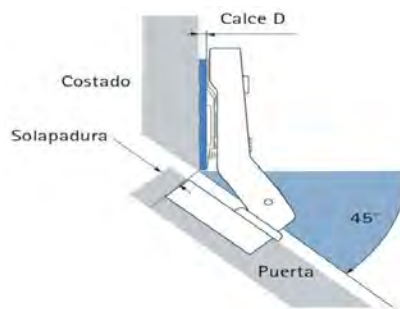
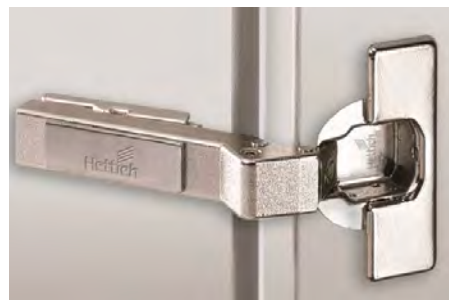

DESCRIPCIÓN Description	CÓDIGO Code
Bisagra Intermat 45° T43 / 45° T43 Intermat hinge	9900308

BISAGRA DE MONTAJE RAPIDO INTERMAT 90°

Fast assembly 90° Intermat hinge

■ CARACTERÍSTICAS TÉCNICAS:

Bisagra automática con montaje por clip. Con cierre automático.
 Para grosores de puerta a partir de 16 mm. Diámetro de cazoleta 35 mm.
 Ajuste de profundidad integrado + 2 mm/ -2,5 mm.
 Ajuste de fuga por excéntrica integrado +3,5 mm./-0,5 mm.
 Ajuste de altura mediante suplemento ± 2 mm.
 Cazoleta de bisagra en acero niquelado.
 Brazo de bisagra en zamak niquelado.

■ FEATURES:

Snap-on hinge using clip. For doors at least 16 mm. thick.
 Cup diameter 35 mm. Automatic closure.
 Integrated depth adjustment + 2 mm / -2.5 mm.
 Integrated gap adjustment for eccenric hinges +3,5 mm./-0,5 mm.
 Height adjustment using wing mouting plate ± 2 mm.
 Hinge cup made of nickel steel.
 HInge arm made of nickel zamak.

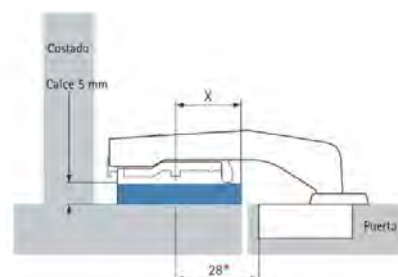

DESCRIPCIÓN Description	CÓDIGO Code
Bisagra Intermat 90° T43 / 90° T43 Intermat hinge	9900310

BISAGRA DE MONTAJE RAPIDO INTERMAT 30°

Fast assembly 30° Intermat hinge

■ CARACTERÍSTICAS TÉCNICAS:

Bisagra automática con montaje por clip. Con cierre automático.
 Para módulos en diagonal con ángulo de cuerpo de 30°.
 Para grosores de puerta a partir de 16 mm. Diámetro de cazoleta 35 mm.
 Ajuste de solapadura integrado + 2 mm/- 2,5 mm.
 Ajuste de profundidad por excéntrica integrado + 3,5 mm/- 0,5 mm.
 Ajuste de altura mediante suplemento ± 2 mm.
 Cazoleta de bisagra en acero niquelado.

■ FEATURES:

Snap-on hinge using clip. For doors at least 16 mm. thick.
 For diagonal units with a body angle of 30°.
 Cup diameter 35 mm.
 Side adjustment + 2 mm / - 2.5 mm.
 Integrated gap adjustment for eccenric hinges +3,5 mm./-0,5 mm.
 Height adjustment using wing mounting plate ± 2mm.
 Hinge cup made of nickel steel.
 Hinge arm made of nickel zamak. 7 mm. cranking.



DESCRIPCIÓN Description	CÓDIGO Code
Bisagra Intermat 30° T43 / 30° T43 Intermat hinge	9900306

BISAGRA DE MONTAJE RAPIDO INTERMAT 50° / 65°

Fast assenbly 50°/65° Intermat hinge

■ CARACTERÍSTICAS TÉCNICAS:

Bisagra automática con montaje por clip. Con cierre automático.
 Para unión de puertas en módulos de rincón angular.
 Para grosores de puerta a partir de 16 mm. Diámetro de cazoleta 35 mm.
 Ajuste de profundidad y diagonal integrado.
 Ajuste de profundidad por excéntrica integrado.
 Ajuste de altura mediante suplemento ± 2 mm.
 Cazoleta de bisagra en acero niquelado.
 Brazo de bisagra en zamak niquelado.

■ FEATURES:

Snap-on hinge using clip. For doors at least 16 mm. thick.
 For joining doors in units with angluar corners.
 Cup diameter 35 mm. Automatic closure.
 Integrated depth and diagonal adjustment.
 Integrated depth adjustment for eccentric hinges.
 Heigth adjustment using wing mounting plate ± 2 mm.
 Hinge cup made of nickel steel.
 Hinge arm amde of nickel zamak.

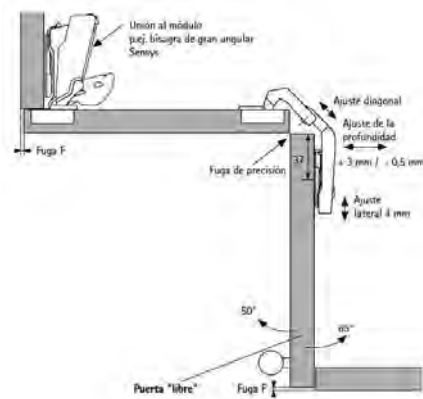

DESCRIPCIÓN Description	CÓDIGO Code
Bisagra Intermat 50°/65° T43 / 50°/65° T43 Intermat hinge	9900314

BISAGRA DE MONTAJE RAPIDO CON AMORTIGUACION INTEGRADA SENSYS 110°*Fast assembly 110° hinge with integrated damping Sensys***■ CARACTERÍSTICAS TÉCNICAS:**

Bisagra automática con montaje por clip.

El sistema de amortiguación, se encuentra integrado de modo invisible en el brazo de la bisagra. Cierre silencioso y uniforme debido a la auto retracción desde aprox. 35°.

Para puertas con grosores de 15 a 22 mm. Con cierre automático.

Ajuste de solapadura integrado ± 2 mm.

Ajuste de profundidad integrado + 3 mm / - 2 mm.

Ajuste de altura mediante suplemento.

Cazoleta / brazo de bisagra: acero niquelado.

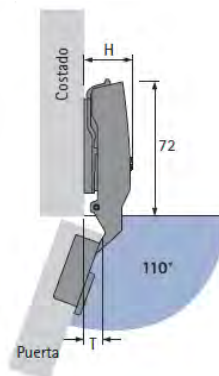
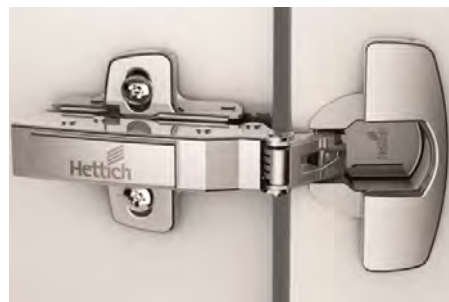
■ FEATURES:*Snap-on hinge using clip. The damping system is integrated and concealed in the hinge arm. Silent and uniform closure thanks to pull-function when the open angle is 35°.**For doors 15 mm. to 22 mm. thick. Automatic closure.**Integrated side adjustment ± 2 mm.**Integrated depth adjustment + 3 mm / - 2 mm.**Height adjustment using wing mounting plate.**Hinge cup / arm made of nickel steel.*

DESCRIPCIÓN Description	CÓDIGO Code
Bisagra Sensys 110° TH 53 / 110° TH 53 Sensys hinge	9902688

BISAGRA DE MONTAJE RAPIDO CON AMORTIGUACION INTEGRADA SENSYS 165°*Fast assembly 165° hinge with integrated damping Sensys***■ CARACTERÍSTICAS TÉCNICAS:**

El sistema de amortiguación, se encuentra integrado de modo invisible en el brazo de la bisagra. Cierre silencioso y uniforme debido a la auto retracción desde aprox. 35°.

Para puertas con grosores de 15 a 22 mm. Con cierre automático.

Ningún resalte de puerta, espacio interior libre para cajones. El Angulo de la puerta se puede reducir en continuo hasta 120° mediante el tornillo de ajuste.

Ajuste de solapadura integrado + 1,0 mm/- 2,5 mm.

Ajuste de profundidad integrado ± 2 mm.

Ajuste de altura mediante suplemento.

Cazoleta / brazo de bisagra: acero niquelado.

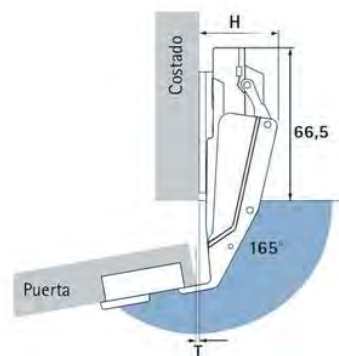
■ FEATURES:*Snap-on hinge using clip. The damping system is integrated and concealed in the hinge arm. Silent and uniform closure thanks to pull-function when the open angle is 35°.**For doors 15 mm. to 22 mm. thick. Automatic closure.**The opening angle can be reduced to 130° using the adjustment screw.**Ideal for corners.**Integrated side adjustment + 1.0 mm / - 2.5 mm.**Integrated depth adjustment ± 2 mm.**Height adjustment using wing mounting plate.**Hinge cup / arm made of nickel steel.*

DESCRIPCIÓN Description	CÓDIGO Code
Bisagra Sensys 165° TH 53 / 165° TH 53 Sensys hinge	9906257

BISAGRA DE MONTAJE RAPIDO CON AMORTIGUACION INTEGRADA SENSYS 45°

Fast assembly 45° hinge with integrated damping Sensys

■ CARACTERÍSTICAS TÉCNICAS:

Bisagra automática con montaje por clip.

El sistema de amortiguación, se encuentra integrado de modo invisible en el brazo de la bisagra. Cierre silencioso y uniforme debido a la auto retracción desde aprox. 35°.

Para puertas con grosores de 15 a 22 mm. Con cierre automático.

Para módulos de rincón con ángulo de mueble de 45°.

Diámetro de cazoleta 35 mm. Con cierre automático.

Ajuste de solapadura integrado ± 2 mm.

Ajuste de profundidad integrado + 3 mm / - 2 mm.

Ajuste de altura mediante suplemento.

Cazoleta / brazo de bisagra: acero niquelado.

■ FEATURES:

Snap-on hinge using clip. The damping system is integrated and concealed in the hinge arm. Silent and uniform closure thanks to pull-function when the open angle is 35°.

For doors 15 mm. to 22 mm. thick. Automatic closure.

For corner units with face angle of 45°.

Integrated side adjustment ± 2 mm.

Integrated depth adjustment + 3 mm / - 2 mm.

Height adjustment using wing mounting plate.

Hinge cup / arm made of nickel steel.

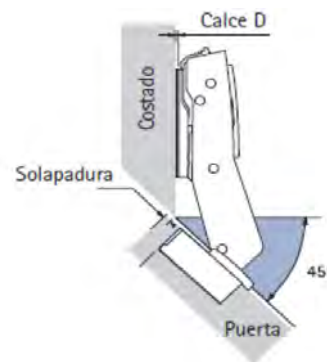

DESCRIPCIÓN Description	CÓDIGO Code
Bisagra Sensys 45° TH 53 / 45° TH 53 Sensys hinge	9902684

BISAGRA DE MONTAJE RAPIDO CON AMORTIGUACION INTEGRADA SENSYS 90°

Fast assembly 90° hinge with integrated damping Sensys

■ CARACTERÍSTICAS TÉCNICAS:

Bisagra automática con montaje por clip.

El sistema de amortiguación, se encuentra integrado de modo invisible en el brazo de la bisagra. Cierre silencioso y uniforme debido a la auto retracción desde aprox. 35°.

Para puertas con grosores de 15 a 22 mm. Con cierre automático.

Para módulos de falso rincón.

Reajuste integrado para el salto de puerta + 1 mm / - 2 mm.

Reajuste integrado de juntas + 3 mm / - 2 mm.

Ajuste de altura mediante suplemento.

Cazoleta / brazo de bisagra: acero niquelado.

■ FEATURES:

Snap-on hinge using clip. The damping system is integrated and concealed in the hinge arm. Silent and uniform closure thanks to pull-function when the open angle is 35°.

For doors 15 mm. to 22 mm. thick. Automatic closure.

For false corner units.

Integrated overlay adjustment + 1 mm. / - 2 mm.

Integrated joint adjustment + 3 mm / - 2 mm.

Height adjustment using wing mounting plate.

Hinge cup / arm made of nickel steel.

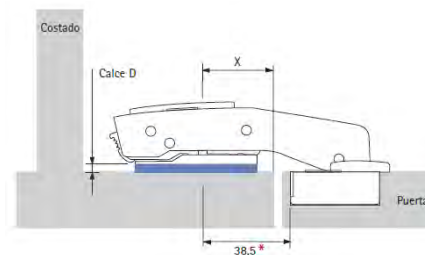

DESCRIPCIÓN Description	CÓDIGO Code
Bisagra Sensys 90° TH 53 / 90° TH 53 Sensys hinge	9902685

BISAGRA DE MONTAJE RAPIDO CON AMORTIGUACION INTEGRADA SENSYS 30°*Fast assembly 30° hinge with integrated damping Sensys***■ CARACTERÍSTICAS TÉCNICAS:**

Bisagra automática con montaje por clip.

El sistema de amortiguación, se encuentra integrado de modo invisible en el brazo de la bisagra. Cierre silencioso y uniforme debido a la auto retracción desde aprox. 35°.

Para puertas con grosores de 15 a 22 mm. Con cierre automático.

Para módulos en diagonal con ángulo de cuerpo de 30°.

Ajuste de solapadura integrado ± 2 mm.

Ajuste de profundidad integrado + 3 mm / - 2 mm.

Ajuste de altura mediante suplemento.

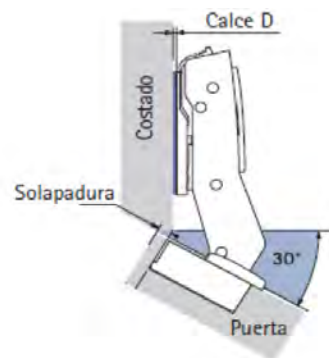
■ FEATURES:*Snap-on hinge using clip. The damping system is integrated and concealed in the hinge arm. Silent and uniform closure thanks to pull-function when the open angle is 35°.**For doors 15 mm. to 22 mm. thick. Automatic closure.**For diagonal units with a faceangle of 30°.**Integrated side adjustment ± 2 mm.**Integrated depth adjustment + 3 mm. / - 2 mm.**Height adjustment using wing mounting plate.**Hinge cup / arm made of nickel steel.*

DESCRIPCIÓN Description	CÓDIGO Code
Bisagra Sensys 30° TH 53 / 30° TH 53 Sensys hinge	9903443

BISAGRA DE MONTAJE RAPIDO CON AMORTIGUACION INTEGRADA SENSYS 95° MARCO ALUMINIO*Fast assembly 95° hinge with integrated damping system for aluminium frame doors***■ CARACTERÍSTICAS TÉCNICAS:**

Bisagra automática con montaje por clip.

El sistema de amortiguación, se encuentra integrado de modo invisible en el brazo de la bisagra. Cierre silencioso y uniforme debido a la auto retracción desde aprox. 35°.

Para perfil vitrina en marco de aluminio de 20x20 mm grosor. Con cierre automático.

Ajuste de solapadura integrado ± 2 mm.

Ajuste de profundidad integrado + 3 mm / - 2 mm.

Ajuste de altura mediante suplemento.

Cazoleta / brazo de bisagra: acero niquelado.

2 tornillos de fijación para cazoleta de bisagra incluidos.

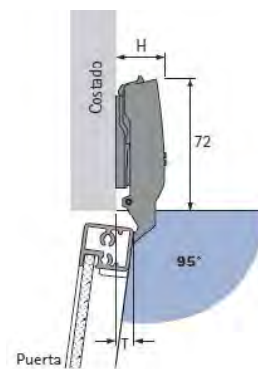
■ FEATURES:*Snap-on hinge using clip. The damping system is integrated and concealed in the hinge arm. Silent and uniform closure thanks to pull-function when the open angle is 35°.**For 20x20 mm.thick aluminium frame profiles. Automatic closure.**Integrated side adjustment ± 2 mm.**Integrated depth adjustment + 3 mm / - 2 mm.**Height adjustment using wing mounting plate.**Hinge cup / arm made of nickel steel.**2 mounting screws for hinge cup included.*

DESCRIPCIÓN Description	CÓDIGO Code
Bisagra Sensys 95° Alu T32 / 95° T32 alu Sensys hinge	9903448

PLACA BASE MONTAJE DIRECTO PARA BISAGRAS INTERMAT y SENSYS

Intermat and Sensys direct mounting hinge mounting plates

■ CARACTERÍSTICAS TÉCNICAS:

A partir de 15 mm de espesor. Separación de taladros 32 mm.
 Con tornillos especiales premontados y tacos de plasticos para taladros
 $\varnothing 5 \times 12$ mm.
 Ajuste de altura por excéntrica ± 2 mm.
 Zamak niquelado.

■ FEATURES:

Minimum thickness of 15 mm. 32 mm.between mounting holes.
 Comes with special pre-mounted screws and plastic anchors for
 holes with a diameter of 5 mm. and a lenght of 12 mm.
 Heigth adjustment for eccentric hinges ± 2 mm. Nickel zamak.

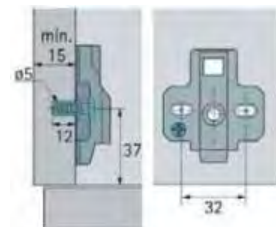

DESCRIPCIÓN Description	CÓDIGO Code
Placa base montaje directo TH 53 / TH 53 mounting plate	9902692
Placa base montaje directo TH 53 calce 0 / TH 53 mounting plate	9903969

PLACAS ANGULARES PARA SUPLEMENTO DE BASES

Parallel distance plates for wing mounting plates

■ CARACTERÍSTICAS TÉCNICAS:

Placas angulares en plástico gris para suplemento de
 bases para bisagras.
 Las placas angulares son apilables, pudiéndose
 incrementar el ángulo del mueble.
 Siempre que se utilicen placas angulares es
 aconsejable realizar una prueba.

■ FEATURES:

Plastic silver-grey parallel distance plates for wing
 mounting plates for hinges.
 These parallel distance paltes are stackable and can
 thus increase the angle of the unit.
 It is advisable to do a trial whenever using parallel
 distance plates.

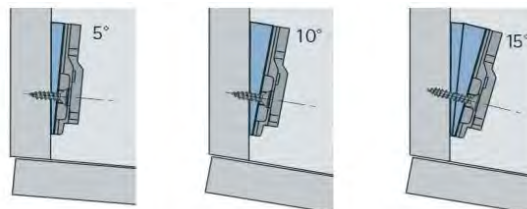

DESCRIPCIÓN Description	CÓDIGO Code
Placa angular 5° / 5° parallel distance plates	9900319
Placa angular 10° / 10° parallel distance plates	9900320

TAPAS DECORATIVAS PARA BISAGRAS SENSYS

Decorative covers for Sensys hinges

■ CARACTERÍSTICAS TÉCNICAS:

Tapa decorativa para brazo de bisagra Sensys.
 Tapa decorativa para cazoleta de bisagra Sensys.
 Acero niquelado.

■ FEATURES:

Decorative cover for Sensys hinge arm.
 Decorative hinge cup for Sensys hinge arm.
 It is advisable to do a trial whenever using parallel distance plates.



DESCRIPCIÓN Description	CÓDIGO Code
Tapa brazo Sensys / Cover Sensys hinge	9902696
Tapa cazoleta Sensys / Hinge cup Sensys hinge	9902695

BISAGRAS Y BASES PARA VITRINAS ALUMINIO 20x20 mm.

Hinges and mounting plate for aluminium doors 20x20 mm.

■ CARACTERÍSTICAS TÉCNICAS:

Bolsa con bisagras solapadas y bases para kit vitrinas de aluminio 20x20 mm.
Bolsas de 2 y 3 juegos de bisagras.
Acabado: Níquel cromado.

■ FEATURES:

Bag with overlapping bases kit hinges and bases aluminum doors 20x20 mm.
Available in bag 2 and 3 sets of hinges.
Finish: Nickel plated.



DESCRIPCIÓN Description	CÓDIGO Code
Bolsa 2 bisagras + bases 20x20 mm / Bag of 2 hinges 20x20 mm	9903445
Bolsa 3 bisagras + bases 20x20 mm / Bag of 3 hinges 20x20 mm	9903444

SISTEMA DE APERTURA MOVI-CORNER

Movi-corner opening system

■ CARACTERÍSTICAS TÉCNICAS:

Sistema de apertura lateral para módulos de rincón angular.
Acabados: Inox y cromo mate.
Alturas estándar 700 y 900 mm. Diámetro de barra 28 mm.

■ FEATURES:

Lateral opening system for angular corner units.
Finishes: Stainless steel and Matte chrome.
Standard heights of 700 and 900 mm. Rod diameter 28 mm.

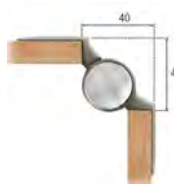

DESCRIPCIÓN Description	CÓDIGO Code
Movi-corner 700 mm cromo mate / Matte chrome 700 mm	9900322
Movi-corner 700 mm Inox / Stainless steel 700 mm	9900323
Movi-corner 900 mm cromo mate / Matte chrome 900 mm	9900324
Movi-corner 900 mm Inox / Stainless steel 900 mm	9900325

SISTEMA DE APERTURA RINCObASIC

Rincobasic opening system

■ CARACTERÍSTICAS TÉCNICAS:

Sistema de unión indicado para puertas rincón con tirador integrado tipo "J"
Acabados: Plata mate, Inox y blanco.
Alturas estándar 700, 800 y 900 mm. Ancho de barra 40 mm.

■ FEATURES:

Connection system indicated for corner doors with integrated handle type "J"
Finishes: Matt silver, stainless steel and white.
Standard heights 700, 800 and 900 mm. 40 mm bar width.

DESCRIPCIÓN Description	CÓDIGO Code
Bisagra Rincobasic 700 mm plata mate / Rincobasic silver 700 mm	9908845
Bisagra Rincobasic 800 mm plata mate / Rincobasic silver 800 mm	9908849
Bisagra Rincobasic 900 mm plata mate / Rincobasic silver 900 mm	9908880
Bisagra Rincobasic 700 mm Inox / Rincobasic stainless steel 700 mm	9908846
Bisagra Rincobasic 800 mm Inox / Rincobasic stainless steel 800 mm	9908850
Bisagra Rincobasic 900 mm Inox / Rincobasic stainless steel 900 mm	9908881
Bisagra Rincobasic 700 mm blanco / Rincobasic white 700 mm	9908848
Bisagra Rincobasic 800 mm blanco / Rincobasic white 800 mm	9908852
Bisagra Rincobasic 900 mm blanco / Rincobasic white 900 mm	9908883

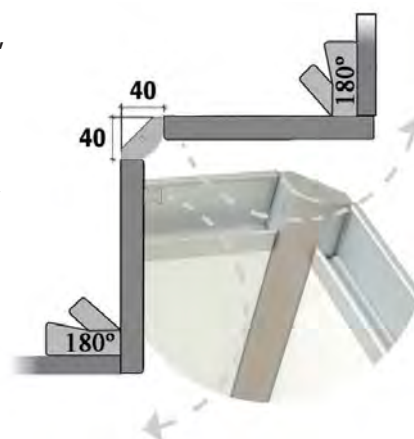

SET PISTON DE GAS ELEVABLE 164 mm. / Set of gas springs 164 mm.

■ CARACTERÍSTICAS TÉCNICAS:

Set pistón de gas para puertas de madera y aluminio elevables. Para ángulos de apertura 80°, 90° y 100° en función del montaje del adaptador para la puerta. Terminación gris. El set incluye: enganche para lateral modulo, adaptador para puerta madera y adaptador para puerta aluminio. Peso de puerta 5 kg.

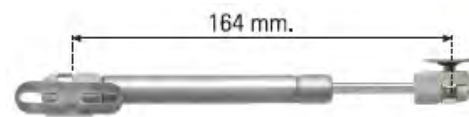

■ FEATURES:

Set of gas spring for raisable wood and aluminium doors. For opening angles of 80°/90°/100° depending on how the adapter is mounted to the door. Grey finish. The set includes: side hook for unit, wood door adapter and aluminium door adapter. Door weight 5 kg.

DESCRIPCIÓN Description	CÓDIGO Code
Pistón 164 mm 5 Kg / 164 mm spring 5 Kg	9900297

SET PISTON DE GAS ELEVABLE 247 mm. / Set of gas springs 247 mm.

■ CARACTERÍSTICAS TÉCNICAS:

Set pistón de gas para puertas de madera y aluminio elevables. Para ángulos de apertura 80°, 90° y 100° en función del montaje del adaptador para la puerta. Terminación gris. El set incluye: enganche para lateral modulo, adaptador para puerta madera y adaptador para puerta aluminio. Peso de puerta 5, 8 y 12 kg.



■ FEATURES:

Set of gas spring for raisable wood and aluminium doors. For opening angles of 80°/90°/100° depending on how the adapter is mounted to the door. Grey finish. The set includes: side hook for unit, wood door adapter and aluminium door adapter. Door weight 5, 8 and 12 kg.

DESCRIPCIÓN Description	CÓDIGO Code
Pistón 247 mm 5 Kg / 247 mm spring 5 Kg	9900298
Pistón 247 mm 8 Kg / 247 mm spring 8 Kg	9900299
Pistón 247 mm 12 Kg / 247 mm spring 12 Kg	9900300

PULSADORES UNIVERSAL PUSH-TO-OPEN / Push-to-open universal door opener

■ CARACTERÍSTICAS TÉCNICAS:

Sistema de apertura para puertas sin tirador. Medida de expulsión 40 mm. (realizar siempre una prueba) Acabado gris.

■ FEATURES:

Opening system for doors without handles. Expulsion measure 40 mm. (always do a test) Gray finish.



Superficie / Surface



Embutido / Inlay

DESCRIPCIÓN Description	CÓDIGO Code
Pulsador superficie Pusck-to-open / Push-to-open surface	9902687
Pulsador embutido ø 8x75 mm / Pusck receded ø 8x75 mm	9908020

SISTEMA ELEVABLE ABATIBLE HK-S 350 mm. / HK-S lifting system 350 mm.**■ CARACTERÍSTICAS TÉCNICAS:**

Sistema de elevación abatible y posicionable BLUM para frentes de madera, marcos dealuminio anchos y marcos de aluminio 20 mm.

El sistema de compas se abre fácilmente y se detiene en cualquier posición facilitando el acceso a módulos apaisados. Blumotion proporciona un cierre suave y silencioso.

Para modulo con altura 350 mm.

Angulo de apertura 107°. Profundidad interior, mínimo 240 mm.

En opción Push, incluye mecanismo de expulsión.

Acabado: mecanismo en acero y carcasa en plástico gris.

■ FEATURES:

BLUM folding and positionable lifting system for wooden fronts, frames aluminum widths and aluminum frames 20 mm.

The compass system opens easily and stops in any position facilitating access to landscape modules. Blumotion provides a smooth and silent closure.

For module with height 350 mm.

107° opening angle. Interior depth, minimum 240 mm.

In Push option, includes ejection mechanism.

Finish: steel mechanism and gray plastic housing



DESCRIPCIÓN <i>Description</i>	CÓDIGO <i>Code</i>
Kit elevación HK-S 350X600 mm madera-aluminio / <i>HK-S 350X600 mm wooden-aluminum lifting kit</i>	9904235
Kit elevación HK-S 350X700 mm madera-aluminio / <i>HK-S 350X700 mm wooden-aluminum lifting kit</i>	9904235
Kit elevación HK-S 350X900 mm madera-aluminio / <i>HK-S 350X900 mm wooden-aluminum lifting kit</i>	9904236
Kit elevación HK-S 350X600 mm aluminio 20x20 / <i>HK-S 350X600 mm aluminum 20x20 lifting kit</i>	9904204
Kit elevación HK-S 350X700 mm aluminio 20x20 / <i>HK-S 350X700 mm aluminum 20x20 lifting kit</i>	9904204
Kit elevación HK-S 350X900 mm aluminio 20x20 / <i>HK-S 350X900 mm aluminum 20x20 lifting kit</i>	9904205
Kit elevación HK-S PUSCH 350X600 mm madera-aluminio / <i>Kit HK-S PUSCH 350X600 mm wooden-aluminum</i>	9904495
Kit elevación HK-S PUSCH 350X700 mm madera-aluminio / <i>Kit HK-S PUSCH 350X700 mm wooden-aluminum</i>	9904495
Kit elevación HK-S PUSCH 350X900 mm madera-aluminio / <i>Kit HK-S PUSCH 350X900 mm wooden-aluminum</i>	9904496
Kit elevación HK-S PUSCH 350X600 mm aluminio 20x20 / <i>HK-S PUSCH 350X600 mm aluminum 20x20</i>	9904501
Kit elevación HK-S PUSCH 350X700 mm aluminio 20x20 / <i>HK-S PUSCH 350X700 mm aluminum 20x20</i>	9904501
Kit elevación HK-S PUSCH 350X900 mm aluminio 20x20 / <i>HK-S PUSCH 350X900 mm aluminum 20x20</i>	9904502



SISTEMA ELEVABLE ABATIBLE HK 450 y 600 mm. / HK lifting system 450 and 600 mm.

■ CARACTERÍSTICAS TÉCNICAS:

Sistema de elevación abatible y posicionable BLUM para frentes de madera, marcos de aluminio anchos y marcos de aluminio 20 mm.

El sistema de compas se abre fácilmente y se detiene en cualquier posición facilitando el acceso a módulos apaisados. Blumotion proporciona un cierre suave y silencioso.

Para módulos con altura 450 y 600 mm.

Angulo de apertura 107°. Profundidad interior, mínimo 240 mm.

En opción Push, incluye mecanismo de expulsión.

Acabado: mecanismo en acero y carcasa en plástico gris.

■ FEATURES:

BLUM folding and positionable lifting system for wooden fronts, frames aluminum widths and aluminum frames 20 mm.

The compass system opens easily and stops in any position facilitating access to landscape modules. Blumotion provides a smooth and silent closure.

For modules with height 450 and 600 mm.

107° opening angle. Interior depth, minimum 240 mm.

In Push option, includes ejection mechanism.

Finish: steel mechanism and gray plastic housing



DESCRIPCIÓN Description	CÓDIGO Code
Kit elevación HK 450X600 mm madera-aluminio / HK 450X600 mm wooden-aluminum lifting kit	9904236
Kit elevación HK 450X700 mm madera-aluminio / HK 450X700 mm wooden-aluminum lifting kit	9904237
Kit elevación HK 450X900 mm madera-aluminio / HK 450X900 mm wooden-aluminum lifting kit	9904238
Kit elevación HK 450X600 mm aluminio 20x20 / HK 450X600 mm aluminum 20x20 lifting kit	9904205
Kit elevación HK 450X700 mm aluminio 20x20 / HK 450X700 mm aluminum 20x20 lifting kit	9904206
Kit elevación HK 450X900 mm aluminio 20x20 / HK 450X900 mm aluminum 20x20 lifting kit	9904207
Kit elevación HK PUSCH 450X600 mm madera-aluminio / Kit HK PUSCH 450X600 mm wooden-aluminum	9904496
Kit elevación HK PUSCH 450X700 mm madera-aluminio / Kit HK PUSCH 450X700 mm wooden-aluminum	9904497
Kit elevación HK PUSCH 450X900 mm madera-aluminio / Kit HK PUSCH 450X900 mm wooden-aluminum	9904498
Kit elevación HK PUSCH 450X600 mm aluminio 20x20 / HK PUSCH 450X600 mm aluminum 20x20	9904502
Kit elevación HK PUSCH 450X700 mm aluminio 20x20 / HK PUSCH 450X700 mm aluminum 20x20	9904503
Kit elevación HK PUSCH 450X900 mm aluminio 20x20 / HK PUSCH 450X900 mm aluminum 20x20	9904504

DESCRIPCIÓN Description	CÓDIGO Code
Kit elevación HK 600X600 mm madera-aluminio / HK 600X600 mm wooden-aluminum lifting kit	9904238
Kit elevación HK 600X700 mm madera-aluminio / HK 600X700 mm wooden-aluminum lifting kit	9906475
Kit elevación HK 600X900 mm madera-aluminio / HK 600X900 mm wooden-aluminum lifting kit	9906476
Kit elevación HK 600X600 mm aluminio 20x20 / HK 600X600 mm aluminum 20x20 lifting kit	9904207
Kit elevación HK 600X700 mm aluminio 20x20 / HK 600X700 mm aluminum 20x20 lifting kit	9906477
Kit elevación HK 600X900 mm aluminio 20x20 / HK 600X900 mm aluminum 20x20 lifting kit	9906478
Kit elevación HK PUSCH 600X600 mm madera-aluminio / Kit HK PUSCH 600X600 mm wooden-aluminum	9904499
Kit elevación HK PUSCH 600X700 mm madera-aluminio / Kit HK PUSCH 600X700 mm wooden-aluminum	9906479
Kit elevación HK PUSCH 600X900 mm madera-aluminio / Kit HK PUSCH 600X900 mm wooden-aluminum	9906480
Kit elevación HK PUSCH 600X600 mm aluminio 20x20 / HK PUSCH 600X600 mm aluminum 20x20	9904505
Kit elevación HK PUSCH 600X700 mm aluminio 20x20 / HK PUSCH 600X700 mm aluminum 20x20	9906481
Kit elevación HK PUSCH 600X900 mm aluminio 20x20 / HK PUSCH 600X900 mm aluminum 20x20	9906482



SISTEMA ELEVABLE PLEGABLE HF 700 y 900 mm.*HF elevation folding system 700 and 900 mm.***■ CARACTERÍSTICAS TÉCNICAS:**

Sistema de elevación plegable y posicionable BLUM para frentes de madera y marcos de aluminio anchos.

El sistema de compas se abre fácilmente y se detiene en cualquier posición facilitando el acceso a módulos altos. Blumotion proporciona un cierre suave y silencioso.

Para módulos con altura 700 y 900 mm.

Profundidad interior, mínimo 278 mm.

Acabado: mecanismo en acero y carcasa en plástico gris.

■ FEATURES:

BLUM folding and positionable lifting system for wooden fronts and frames wide aluminum.

The compass system opens easily and stops in any position facilitating access to tall modules. Blumotion provides a smooth and silent closure. For modules with height 700 and 900 mm.

Interior depth, minimum 278 mm.

Finish: steel mechanism and gray plastic housing.



DESCRIPCIÓN <i>Description</i>	CÓDIGO <i>Code</i>
Kit elevación HF 700X600 mm madera-aluminio / <i>HF 700X600 mm wooden-aluminum elevation kit</i>	9910760
Kit elevación HF 700X700 mm madera-aluminio / <i>HF 700X700 mm wooden-aluminum elevation kit</i>	9910760
Kit elevación HF 700X900 mm madera-aluminio / <i>HF 700X900 mm wooden-aluminum elevation kit</i>	9910761

DESCRIPCIÓN <i>Description</i>	CÓDIGO <i>Code</i>
Kit elevación HF 900X600 mm madera-aluminio / <i>HF 900X600 mm wooden-aluminum elevation kit</i>	9910761
Kit elevación HF 900X700 mm madera-aluminio / <i>HF 900X700 mm wooden-aluminum elevation kit</i>	9910761
Kit elevación HF 900X900 mm madera-aluminio / <i>HF 900X900 mm wooden-aluminum elevation kit</i>	9910762



SISTEMA ELEVABLE VERTICAL HL 350 y 450 mm.

HL elevation vertical system 350 y 450 mm.

■ **CARACTERÍSTICAS TÉCNICAS:**

Sistema de elevación vertical y posicionable BLUM para frentes de madera y marcos de aluminio anchos.

El sistema de compas se abre fácilmente y se detiene en cualquier posición facilitando el acceso a módulos apaisados. Blumotion proporciona un cierre suave y silencioso.

Para módulos con altura 350 y 450 mm.

Profundidad interior, mínimo 278 mm.

Acabado: mecanismo en acero y carcasa en plástico gris.

■ **FEATURES:**

BLUM vertical and positionable lifting system for wooden fronts and frames wide aluminum.

The compass system opens easily and stops in any position facilitating access to landscape modules. Blumotion provides a smooth and silent closure.

For modules with height 350 and 450 mm.

Interior depth, minimum 278 mm.

Finish: steel mechanism and gray plastic housing.



DESCRIPCIÓN Description	CÓDIGO Code
Kit elevación HL 350X600 mm madera-aluminio / HL 350X600 mm wooden-aluminum vertical kit	9904240
Kit elevación HL 350X700 mm madera-aluminio / HL 350X700 mm wooden-aluminum vertical kit	9904241
Kit elevación HL 350X900 mm madera-aluminio / HL 350X900 mm wooden-aluminum vertical kit	9904242

DESCRIPCIÓN Description	CÓDIGO Code
Kit elevación HL 450X600 mm madera-aluminio / HL 450X600 mm wooden-aluminum vertical kit	9904243
Kit elevación HL 450X700 mm madera-aluminio / HL 450X700 mm wooden-aluminum vertical kit	9904244
Kit elevación HL 450X900 mm madera-aluminio / HL 450X900 mm wooden-aluminum vertical kit	9904245

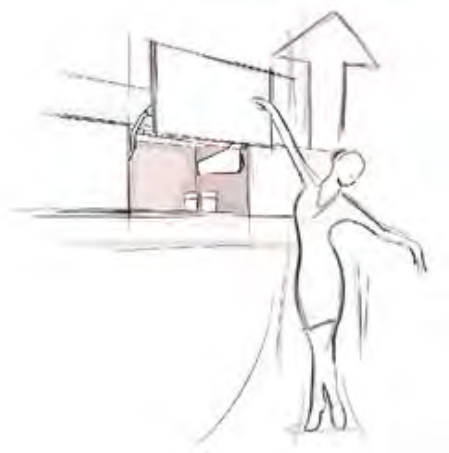

SISTEMA ELEVABLE OBLICUO HS 450 y 600 mm.*HS elevation oblique system 450 and 600 mm.***■ CARACTERÍSTICAS TÉCNICAS:**

Sistema de elevación oblicuo y posicionable BLUM para frentes de madera y marcos dealuminio anchos.

El sistema de compas se abre fácilmente y se detiene en cualquier posición facilitando el acceso a módulos apaisados. Blumotion proporciona un cierre suave y silencioso.

Para módulos con alturas 450 y 600 mm.

Profundidad interior, mínimo 276 mm.

Acabado: mecanismo en acero y carcasa en plástico gris.

■ FEATURES:

BLUM oblique and positionable lifting system for wooden fronts and frames wide aluminum.

The compass system opens easily and stops in any position facilitating access to landscape modules. Blumotion provides a smooth and silent closure.

For modules with height 450 and 600 mm.

Interior depth, minimum 276 mm.

Finish: steel mechanism and gray plastic housing.



DESCRIPCIÓN <i>Description</i>	CÓDIGO <i>Code</i>
Kit elevación HS 450X600 mm madera-aluminio / <i>HS 450X600 mm wooden-aluminum oblique kit</i>	9904255
Kit elevación HS 450X700 mm madera-aluminio / <i>HS 450X700 mm wooden-aluminum oblique kit</i>	9904256
Kit elevación HS 450X900 mm madera-aluminio / <i>HS 450X900 mm wooden-aluminum oblique kit</i>	9904257

DESCRIPCIÓN <i>Description</i>	CÓDIGO <i>Code</i>
Kit elevación HS 600X600 mm madera-aluminio / <i>HS 600X600 mm wooden-aluminum oblique kit</i>	9906504
Kit elevación HS 600X700 mm madera-aluminio / <i>HS 600X700 mm wooden-aluminum oblique kit</i>	9906506
Kit elevación HS 600X900 mm madera-aluminio / <i>HS 600X900 mm wooden-aluminum oblique kit</i>	9906507



SISTEMA CORREDERA 20 PARA KIT VITRINA DE ALUMINIO

20 sliding system for aluminium display case kit

■ CARACTERÍSTICAS TÉCNICAS:

Sistema corredera 20 para kit vitrina de aluminio.
Compuesto por guía superior e inferior en aluminio, tira 3000 mm.
Kit herraje 18x30 para 1 hoja corredera (2 guidores superiores, 2 carros inferiores, 2 topes superiores, 2 topes inferiores y tornillos para fijación).

Disponible solo para modelos: LOGIK y DEKOR.

Kit vitrinas de aluminio no incluidos, hay que pedir por separado.
Peso máximo recomendado por puerta = 25 Kg.

■ FEATURES:

20 sliding system for aluminium display case kit.
Composed of aluminium top and bottom guides, 3000 mm strip.
Set of 18x30 fittings for 1 sliding sheet (2 top guides, 2 bottom wheels, 2 top stoppers, 2 bottom stoppers and mounting screws).

Available only for models: LOGIK and DEKOR.

Aluminium display case kit not included, must be purchased separately.
Maximum recommended weight per door = 25 kg.



DESCRIPCIÓN Description	CÓDIGO Code
Guía superior-inferior 3000 mm / Top-bottom guide 3000 mm	9900354
Kit herraje 18x30 puerta corredera / Fitting kit 18x30 sliding door	9900352

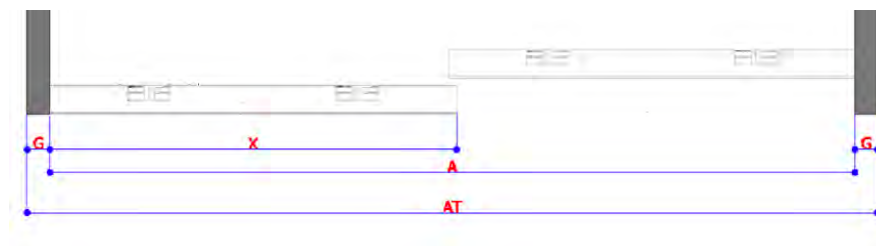

Calculo de ancho para 2 puertas correderas
Width calculation for 2 sliding doors

MODELO Model	CÁLCULO Calculation
LOGIK	$X = AT - (G \times 2) / 2 + 10 \text{ mm}$
DEKOR	$X = AT - (G \times 2) / 2 + 4 \text{ mm}$

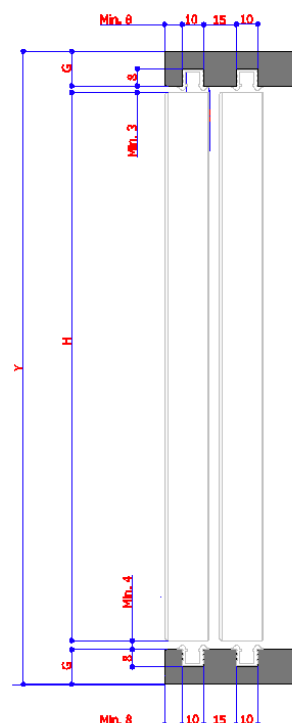

$H = Y - (G \times 2) - 10 \text{ mm}$

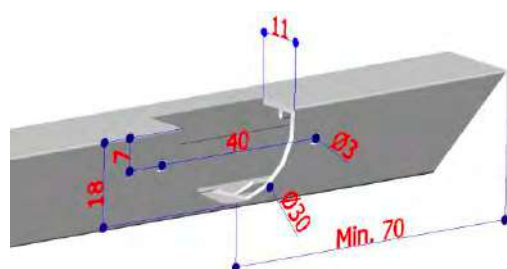

TIRADOR TE PARA KIT VITRINA DE ALUMINIO

TE inlaid handle for aluminium display case kit

■ CARACTERÍSTICAS TÉCNICAS:

Tirador embutido para kit vitrina de aluminio valido para cualquier modelo.

Importante: indicar la posición donde debe ir colocado el tirador, si va centrado o si al contrario va a alguna distancia concreta. Por omisión siempre se colocara centrado.

Acabados: Plata mate y acero.

■ FEATURES:

Inlay handle for aluminum display case kit valid for any model.

Important: must indicate where, the handle is to placed, if it is centred or in a specific place. By default will be centered. Finishes: Mtte silver and steel.



DESCRIPCIÓN Description	CÓDIGO Code
Tirador TE plata mate 150 mm / TE handle matte silver 150 mm	9903476
Tirador TE acero 150 mm / TE handle steel 150 mm	9903466

PERFIL ALUMINIO ADHESIVO PARA VITRINAS EN LAMINADOS

Aluminium profile for glass doors in adhesive laminate

■ CARACTERÍSTICAS TÉCNICAS:

Perfil adhesivo de terminación, para vaciado en puertas vitrinas de laminado.

Disponibile en tiras de 3000 mm. Acabado en cromo mate.

Los ángulos de 90° para terminación se tienen que pedir por separado.

■ FEATURES:

Adhesive profile finish for open spaces in laminate display case doors.

Available in 3000 mm strips. Finish matte chrome.

The 90° corner pieces must be purchased separately.



DESCRIPCIÓN Description	CÓDIGO Code
Perfil Cromo mate 3000 mm / Matte chrome profile 3000 mm	9900358
Angulo 90° Cromo mate / Matte chrome 90° angle	9900360

BALDA DE CRISTAL TEMPLADO PARA MODULO ALTO

Tempered glass shelf module for high

■ CARACTERÍSTICAS TÉCNICAS:

Balda de cristal templado para módulos altos. Grosor 6 mm.

Para módulos con grosor de costado en 16 mm. Cantos pulidos.

■ FEATURES:

Shelf tempered glass for high modules. 6 mm thickness.

For modules with thicknes of 16 mm. Polished edges.



DESCRIPCIÓN Description	MÓDULO Module	CÓDIGO Code
Balda cristal / Shelf glass	400	9905954
Balda cristal / Shelf glass	450	9905955
Balda cristal / Shelf glass	500	9905956
Balda cristal / Shelf glass	600	9905957
Balda cristal / Shelf glass	700	9905958
Balda cristal / Shelf glass	800	9905959
Balda cristal / Shelf glass	900	9905960

KIT VITRINA DE ALUMINIO LOGIK / Logik aluminium display case kit**■ CARACTERÍSTICAS TÉCNICAS:**

Kit vitrina de aluminio compuesto por:

Marco aluminio con junta de goma, escuadras de unión y tornillos fijacion M4x10.

Bisagras no incluidas, hay que pedir las por separado.

Cristal = - 28 mm medidas del marco.

■ FEATURES:

Aluminium display case kit composed of: aluminium frame with rubber seal, corner pieces and M4x10 mounting screws.

Hinges not included, must be purchased separately.

Glass = - 28 mm from frame measurements.

Finishes: Matte silver and steel.

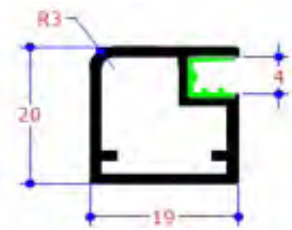

Alto Height	Ancho (unidades de bisagras por medida) / Width (hinges per measures)							
	297	347	397	447	497	597	697	897
348	-	-	-	-	-	2	2	2
448	-	-	-	-	-	2	2	2
598	2	2	2	2	2	2	2	-
698	2	2	2	2	2	2	2	-
798	2	2	2	2	2	2	2	-
898	2	2	2	2	2	2	2	-
1198	3	3	3	3	3	3	3	-
1298	3	3	3	3	3	3	3	-
1398	3	3	3	3	3	3	3	-
1498	3	3	3	3	3	3	3	-
1998	4	4	4	4	4	4	4	-
2198	4	4	4	4	4	4	4	-

KIT VITRINA DE ALUMINIO DEKOR / Dekor aluminium display case kit**■ CARACTERÍSTICAS TÉCNICAS:**

Kit vitrina de aluminio compuesto por:

Marco aluminio con junta de goma, escuadras de unión y tornillos fijacion M4x10.

Bisagras no incluidas, hay que pedir las por separado.

Cristal = - 6 mm medidas del marco.

Acabados: Plata mate.

■ FEATURES:

Aluminium display case kit composed of: aluminium frame with rubber seal, corner pieces and M4x10 mounting screws.

Hinges not included, must be purchased separately.

Glass = - 6 mm from frame measurements.

Finishes: Matte silver.

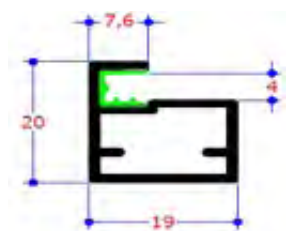

Alto Height	Ancho (unidades de bisagras por medida) / Width (hinges per measures)							
	297	347	397	447	497	597	697	897
348	-	-	-	-	-	2	2	2
448	-	-	-	-	-	2	2	2
598	2	2	2	2	2	2	2	-
698	2	2	2	2	2	2	2	-
798	2	2	2	2	2	2	2	-
898	2	2	2	2	2	2	2	-
1198	3	3	3	3	3	3	3	-
1298	3	3	3	3	3	3	3	-
1398	3	3	3	3	3	3	3	-
1498	3	3	3	3	3	3	3	-
1998	4	4	4	4	4	4	4	-
2198	4	4	4	4	4	4	4	-

KIT VITRINA DE ALUMINIO ALFIL / Alfil aluminium display case kit

■ CARACTERÍSTICAS TÉCNICAS:

Kit vitrina de aluminio compuesto por:
 Marco aluminio con junta de goma, escuadras de unión y tornillos fijacion M4x10.
 Bisagras no incluidas, hay que pedir las por separado.
 Cristal = - 6 mm medidas del marco.
Acabados: Plata mate y acero.

■ FEATURES:

Aluminium display case kit composed of: aluminium frame with rubber seal, corner pieces and M4x10 mounting screws.
 Hinges not included, must be purchased separately.
 Glass = - 6 mm from frame measurements.
Finishes: Matte silver and steel.

Alto Height	Ancho (unidades de bisagras por medida) / Width (hinges per measures)							
	297	347	397	447	497	597	697	897
348	-	-	-	-	-	2	2	2
448	-	-	-	-	-	2	2	2
598	2	2	2	2	2	2	2	-
698	2	2	2	2	2	2	2	-
798	2	2	2	2	2	2	2	-
898	2	2	2	2	2	2	2	-
1198	3	3	3	3	3	3	3	-
1298	3	3	3	3	3	3	3	-
1398	3	3	3	3	3	3	3	-
1498	3	3	3	3	3	3	3	-
1998	4	4	4	4	4	4	4	-
2198	4	4	4	4	4	4	4	-

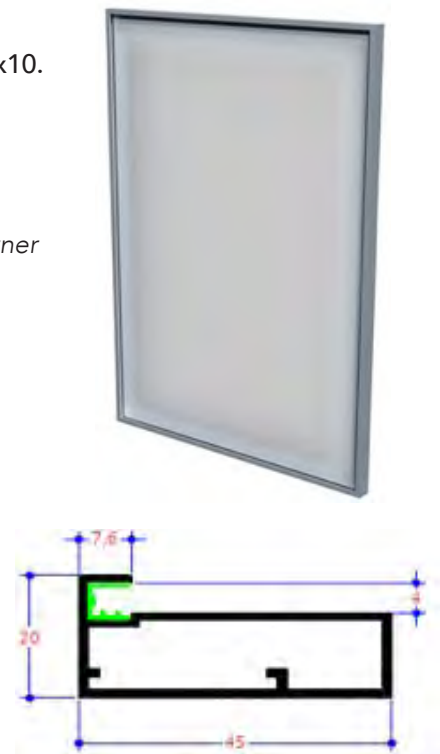

KIT VITRINA DE ALUMINIO AT VERTICAL / At vertical aluminium display case kit

■ CARACTERÍSTICAS TÉCNICAS:

Kit vitrina de aluminio con tirador vertical compuesto por:
 Marco aluminio con junta de goma, escuadras de unión y tornillos fijacion M4x10.
 Bisagras no incluidas, hay que pedir las por separado.
 Cristal = - 6 mm medidas del marco.
Acabados: Plata mate y acero.

■ FEATURES:

Aluminium display case kit with vertical handle composed of: aluminium frame with rubber seal, corner pieces and M4x10 mounting screws.
 Hinges not included, must be purchased separately.
 Glass = - 6 mm from frame measurements.
Finishes: Matte silver.

Alto Height	Ancho (unidades de bisagras por medida) / Width (hinges per measures)							
	297	347	397	447	497	597	697	897
348	-	-	-	-	-	2	2	2
448	-	-	-	-	-	2	2	2
598	2	2	2	2	2	2	2	-
698	2	2	2	2	2	2	2	-
798	2	2	2	2	2	2	2	-
898	2	2	2	2	2	2	2	-
1198	3	3	3	3	3	3	3	-
1298	3	3	3	3	3	3	3	-
1398	3	3	3	3	3	3	3	-
1498	3	3	3	3	3	3	3	-
1998	4	4	4	4	4	4	4	-
2198	4	4	4	4	4	4	4	-



KIT VITRINA DE ALUMINIO AT HORIZONTAL / At horizontal aluminium display case kit**■ CARACTERÍSTICAS TÉCNICAS:**

Kit vitrina de aluminio con tirador horizontal compuesto por:
 Marco aluminio con junta de goma, escuadras de unión y tornillos fijación M4x10.
 Bisagras no incluidas, hay que pedir las por separado.
 Cristal = - 6 mm medidas del marco.
Acabados: Plata mate y acero.

■ FEATURES:

Aluminium display case kit with horizontal handle composed of: aluminium frame with rubber seal, corner pieces and M4x10 mounting screws.
 Hinges not included, must be purchased separately.
 Glass = - 6 mm from frame measurements.
Finishes: Matte silver.

Alto Height	Ancho (unidades de bisagras por medida) / Width (hinges per measures)							
	297	347	397	447	497	597	697	897
348	-	-	-	-	-	2	2	2
448	-	-	-	-	-	2	2	2
598	2	2	2	2	2	2	2	-
698	2	2	2	2	2	2	2	-
798	2	2	2	2	2	2	2	-
898	2	2	2	2	2	2	2	-
1198	3	3	3	3	3	3	3	-
1298	3	3	3	3	3	3	3	-
1398	3	3	3	3	3	3	3	-
1498	3	3	3	3	3	3	3	-
1998	4	4	4	4	4	4	4	-
2198	4	4	4	4	4	4	4	-

**KIT VITRINA DE ALUMINIO MARK / Mark aluminium display case kit****■ CARACTERÍSTICAS TÉCNICAS:**

Kit vitrina de aluminio compuesto por:
 Marco aluminio con junta de goma, escuadras de unión y tornillos fijación M4x10.
 Bisagras no incluidas, hay que pedir las por separado.
 Cristal = - 101 mm medidas del marco.
Acabados: Plata mate y acero.

■ FEATURES:

Aluminium display case kit composed of: aluminium frame with rubber seal, corner pieces and M4x10 mounting screws.
 Hinges not included, must be purchased separately.
 Glass = - 101 mm from frame measurements.
Finishes: Matte silver and steel.

Alto Height	Ancho (unidades de bisagras por medida) / Width (hinges per measures)							
	297	347	397	447	497	597	697	897
348	-	-	-	-	-	2	2	2
448	-	-	-	-	-	2	2	2
598	2	2	2	2	2	2	2	-
698	2	2	2	2	2	2	2	-
798	2	2	2	2	2	2	2	-
898	2	2	2	2	2	2	2	-
1198	3	3	3	3	3	3	3	-
1298	3	3	3	3	3	3	3	-
1398	3	3	3	3	3	3	3	-
1498	3	3	3	3	3	3	3	-
1998	4	4	4	4	4	4	4	-
2198	4	4	4	4	4	4	4	-

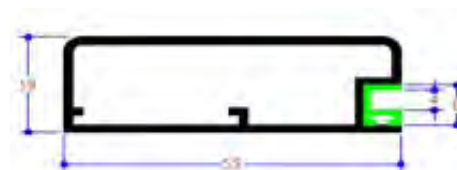

KIT VITRINA DE ALUMINIO CITY / City aluminium display case kit

■ CARACTERÍSTICAS TÉCNICAS:

Kit vitrina de aluminio compuesto por:
 Marco aluminio con junta de goma, escuadras de unión y tornillos fijacion M4x10.
 Bisagras no incluidas, hay que pedir las por separado.
 Cristal = - 2 mm. medidas del marco (cantos cristal pulidos).
Acabados: Plata mate y acero.

■ FEATURES:

Aluminium display case kit composed of: aluminium frame with rubber seal, corner pieces and M4x10 mounting screws.
 Hinges not includes, must be purchased separately.
 Glass = - 2 mm. from frame measurements (polished glass edges).
Finishes: Matte silver and steel.

Alto Height	Ancho (unidades de bisagras por medida) / Width (hinges per measures)							
	297	347	397	447	497	597	697	897
348	-	-	-	-	-	2	2	2
448	-	-	-	-	-	2	2	2
598	2	2	2	2	2	2	2	-
698	2	2	2	2	2	2	2	-
798	2	2	2	2	2	2	2	-
898	2	2	2	2	2	2	2	-
1198	3	3	3	3	3	3	3	-
1298	3	3	3	3	3	3	3	-
1398	3	3	3	3	3	3	3	-
1498	3	3	3	3	3	3	3	-
1998	4	4	4	4	4	4	4	-
2198	4	4	4	4	4	4	4	-



KIT VITRINA DE ALUMINIO ZEN (BB) CON TIRADOR / Zen (BB) aluminium display case kit with handle

■ CARACTERÍSTICAS TÉCNICAS:

Kit vitrina de aluminio compuesto por:
 Marco aluminio con junta de goma, escuadras de unión y tornillos fijacion M4x10.
 Bisagras no incluidas, hay que pedir las por separado.
 Cristal = - 91 mm medida ancho, - 6 mm medida altura del marco.
Acabados: Grafito, blanco y negro.

■ FEATURES:

Aluminium display case kit composed of: aluminium frame with rubber seal, corner pieces and M4x10 mounting screws.
 Hinges not includes, must be purchased separately.
 Glass = - 91 mm width measurement, - 6 mm height from frame measurement.
Finishes: Graphite, black and white.

Alto Height	Ancho (unidades de bisagras por medida) / Width (hinges per measures)							
	297	347	397	447	497	597	697	897
348	-	-	-	-	-	2	2	2
448	-	-	-	-	-	2	2	2
598	2	2	2	2	2	2	2	-
698	2	2	2	2	2	2	2	-
798	2	2	2	2	2	2	2	-
898	2	2	2	2	2	2	2	-
1198	3	3	3	3	3	3	3	-
1298	3	3	3	3	3	3	3	-
1398	3	3	3	3	3	3	3	-
1498	3	3	3	3	3	3	3	-
1998	4	4	4	4	4	4	4	-
2198	4	4	4	4	4	4	4	-

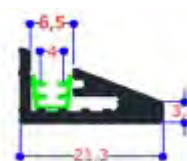

C.

ACCESORIOS DE ACABADO

Other kitchen accessories



TOP FORM

COPETE CLASICO-I PARA ENCIMERAS / Classic-I countertop edging**■ CARACTERÍSTICAS TÉCNICAS:**

Copete Clasico-I de fijación superior en aluminio para encimeras laminadas, con juntas de estanqueidad. Presentación: tira de 3950 mm. Los accesorios de terminación, se tienen que pedir por separado. Acabado en plata brillo.

■ FEATURES:

Classic-I edging aluminium upper fixture for laminate countertops with airtight joints.

Sold as: 3950 mm piece.

Finish accessories, must be ordered separately.

Shiny silver finish.

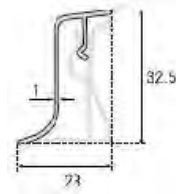

DESCRIPCIÓN <i>Description</i>	CÓDIGO <i>Code</i>
Copete Clasico-I tira 3950 mm / <i>Classic-I edging 3950 mm</i>	9900364
Rincón interior copete / <i>Interior corner edging</i>	9900365
Esquina exterior copete / <i>Exterior corner edging</i>	9900366
Terminación lateral derecha / <i>Right side finish</i>	9900367
Terminación lateral izquierda / <i>Left</i>	9900368

**COPETE LISO 45° PARA ENCIMERAS / 45° smooth countertop edging****■ CARACTERÍSTICAS TÉCNICAS:**

Copete liso 45° de fijación superior en aluminio para encimeras laminadas, con juntas de estanqueidad. Presentación: tira de 3950 mm. Los accesorios de terminación, se tienen que pedir por separado. Acabado en plata brillo.

■ FEATURES:

45° smooth edging aluminium upper fixture for laminate countertops with airtight joints.

Sold as: 3950 mm piece.

Finish accessories, must be ordered separately.

Shiny silver finish.

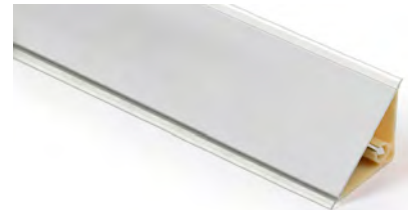

DESCRIPCIÓN <i>Description</i>	CÓDIGO <i>Code</i>
Copete 45° liso tira 3950 mm / <i>45° smooth edging 3950 mm.</i>	9907494
Rincón interior copete / <i>Interior corner edging</i>	9907495
Esquina exterior copete / <i>Exterior corner edging</i>	9907496
Terminación lateral / <i>Side finish</i>	9907497



TERMINACION LATERAL PARA ENCIMERAS / Side finish for worktops

■ CARACTERÍSTICAS TÉCNICAS:

Terminación lateral para encimeras laminadas, plegado doble.
Distintos radios en función del postformado de la encimera.
Acabado en aluminio plata.

■ FEATURES:

Side finish for laminate countertops.
Different sizes available depending on the postformed countertop.
Silver aluminium finish.

DESCRIPCIÓN Description	CÓDIGO Code
Encimera RADIO 3 mm, espesor 30 mm / Radius 3 thickness 30 mm	9903537
Encimera RADIO 3 mm, espesor 38 mm / Radius 3 thickness 38 mm	9903396
Encimera RADIO 8 mm, espesor 30 mm / Radius 8 thickness 30 mm	9900378
Encimera RADIO 8 mm, espesor 38 mm / Radius 8 thickness 38 mm	9903396
Encimera RECTA, espesor 30 mm / Straight thickness 30 mm	9902767
Encimera RECTA, espesor 38 mm / Straight	9902770



TERMINACION UNION EN ANGULO PARA ENCIMERAS / Termination angle union for worktops

■ CARACTERÍSTICAS TÉCNICAS:

Terminación de unión en angulo para encimeras de laminado.
Distintos radios en función del postformado de la encimera.
Acabado en aluminio plata.

■ FEATURES:

Termination angle union for laminate worktops.
Different sizes available depending on the postformed countertop.
Silver aluminium finish.

DESCRIPCIÓN Description	CÓDIGO Code
Encimera RADIO 3 mm, espesor 30 mm / Radius 3 thickness 30 mm	9903539
Encimera RADIO 3 mm, espesor 38 mm / Radius 3 thickness 38 mm	9903397
Encimera RADIO 8 mm, espesor 30 mm / Radius 8 thickness 30 mm	9900379
Encimera RADIO 8 mm, espesor 38 mm / Radius 8 thickness 38 mm	9903397
Encimera RECTA, espesor 30 mm / Straight thickness 30 mm	9902768
Encimera RECTA, espesor 38 mm / Straight thickness 38 mm	9902771



TERMINACION UNION EN RECTO PARA ENCIMERAS / Union in straing termination for worktops

■ CARACTERÍSTICAS TÉCNICAS:

Terminación de unión en recto para encimeras de laminado.
Distintos radios en función del postformado de la encimera.
Acabado en aluminio plata.

■ FEATURES:

Rectal of union in termination for laminate worktops.
Different sizes available depending on the postformed countertop.
Silver aluminium finish.

DESCRIPCIÓN Description	CÓDIGO Code
Encimera RADIO 3 mm, espesor 30 mm / Radius 3 thickness 30 mm	9903538
Encimera RADIO 3 mm, espesor 38 mm / Radius 3 thickness 38 mm	9903398
Encimera RADIO 8 mm, espesor 30 mm / Radius 8 thickness 30 mm	9900380
Encimera RADIO 8 mm, espesor 38 mm / Radius 8 thickness 38 mm	9903398
Encimera RECTA, espesor 30 mm / Straight thickness 30 mm	9902769
Encimera RECTA, espesor 38 mm / Straight thickness 38 mm	9902772



ZÓCALO ALUMINIO PARA MODULOS DE BASE / Aluminium skirting board for stands**■ CARACTERÍSTICAS TÉCNICAS:**

Zócalo de aluminio con junta antihumedad para módulos bajos.
Alturas estandar: 100, 146 y 166 mm.
Presentación: tira de 3950 mm.
Acabado en plata mate.

■ FEATURES:

Aluminium skirting board with anti-moisture joint for short stands.
Standard heights: 100, 146 and 166 mm.
Sold as a 3950 mm piece.
Matte silver finish.



Zócalo aluminio / Aluminium skirting



Rincón flexible / flexible corner

DESCRIPCIÓN Description	CÓDIGO Code
Zócalo aluminio tira 3950x100 mm / Aluminum strip 3950x100 mm	9902940
Zócalo aluminio tira 3950x146 mm / Aluminum strip 3950x146 mm	9900387
Zócalo aluminio tira 3950x166 mm / Aluminum strip 3950x166 mm	9900390
Rincón flexible 100 mm / 100 mm flexible corner	9903092
Rincón flexible 146 mm / 146 mm flexible corner	9900388
Rincón flexible 166 mm / 166 mm flexible corner	9900391
Pinza zócalo aluminio / Aluminium skirting board clip	9900393



Pinza zócalo / Boar clip

ZÓCALO PVC PARA MODULOS DE BASE / PVC skirting board for stands**■ CARACTERÍSTICAS TÉCNICAS:**

Zocalo de PVC con junta antihumedad para módulos bajos.
Alturas estandar: 96, 146 y 166 mm.
Presentación: tira de 3950 mm.
Acabado en blanco e Inox.

■ FEATURES:

PVC skirting board with anti-moisture joint for short stands.
Standard heights: 96, 146 and 166 mm.
Sold as a 3950 mm piece.
White and steel finish.



Zócalo PVC / PVC skirting



Rincón flexible / flexible corner

DESCRIPCIÓN Description	CÓDIGO Code
Zócalo PVC blanco tira 3950x96 mm / PVC white strip 3950x96 mm	9908941
Zócalo PVC blanco tira 3950x146 mm / PVC white strip 3950x146 mm	9908942
Zócalo PVC blanco tira 3950x166 mm / PVC white strip 3950x166 mm	9908943
Rincón flexible blanco 96 mm / 96 mm white flexible corner	9908944
Rincón flexible blanco 146 mm / 146 mm white flexible corner	9908945
Rincón flexible blanco 166 mm / 166 mm white flexible corner	9908946
Zócalo PVC Inox tira 3950x96 mm / PVC steel strip 3950x96 mm	9910691
Zócalo PVC Inox tira 3950x146 mm / PVC steel strip 3950x146 mm	9910694
Zócalo PVC Inox tira 3950x166 mm / PVC steel strip 3950x166 mm	9910697
Rincón flexible Inox 96 mm / 96 mm steel flexible corner	9910692
Rincón flexible Inox 146 mm / 146 mm steel flexible corner	9910695
Rincón flexible Inox 166 mm / 166 mm steel flexible corner	9910698
Pinza zócalo PVC / PVC skirting board clip	9908936



Pinza zócalo / Boar clip

JUNTA ANTIHUMEDAD PARA ZÓCALO / Anti-moisture joint for skirting board

■ CARACTERÍSTICAS TÉCNICAS:

Perfil antihumedad para zócalos laminados. Grosor 19 y 21 mm. Presentación: tira de 3600 mm. Acabado transparente.

■ FEATURES:

Anti-moisture joint for skirting in laminated. For thicknes of 19 and 21 mm. Presentation: 3600 mm strip. Cler finish.

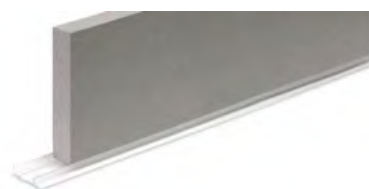

DESCRIPCIÓN Description	CÓDIGO Code
Junta antihumedad 3600x19 mm / Anti-moisture joint 3600x19 mm	9900400
Junta antihumedad 3600x21 mm / Anti-moisture joint 3600x21 mm	9903458

REJILLA DE AIREACION PARA ZÓCALO / Ventilation grating for skirting board

■ CARACTERÍSTICAS TÉCNICAS:

Rejilla aireación en zócalo para ventilación de electrodomesticos integrados. Medidas: 529x83 (ancho x alto mm.) Acabado en cromo mate. Acabado en cromo mate.

■ FEATURES:

Ventilation grating for skirting boards on household appliances. Measurements: 529x83 (width x height in mm.) Matte chrome finish. Matte chrome finish.

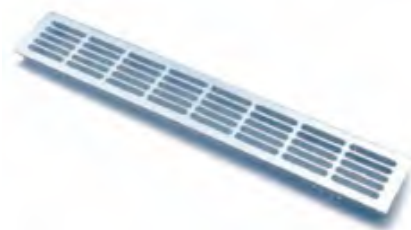

DESCRIPCIÓN Description	CÓDIGO Code
Rejilla aireación zócalo / Ventilation grating for skirting	9900427

MARCO AIREACION PARA MICROONDAS / Microwave trim kit

■ CARACTERÍSTICAS TÉCNICAS:

Kit marco universal en ABS para ventilación de microondas empotrados en mueble. empotrados en mueble. Medidas: 400x600 mm (alto x ancho). Acabados: Niquel satinado y blanco.

■ FEATURES:

Universal ABS trim kit for the ventilation of recessed microwaves. Measurements: 400x600 mm. (Height x widht). Finishes: Satin nickel and white.



DESCRIPCIÓN Description	CÓDIGO Code
Marco niquel satinado / Satin nickel trim kit	9900428
Marco blanco / White trim kit	9900429

REJILLA AIREACION PARA ELECTRODOMESTICOS / Household appliance ventilation trim

■ CARACTERÍSTICAS TÉCNICAS:

Rejilla de ventilación para hornos y frigorificos empotrados. Altura rejilla 124 mm. con 8 lamas. Ancho 600 y 900 mm. Acabados: Inox y blanco.

■ FEATURES:

Ventilation trim for recessed ovens and refrigerators. Trim height 124 mm. with 8 slats. Width 600 abd 900 mm. Finishes: Steel and white.



DESCRIPCIÓN Description	CÓDIGO Code
Rejilla aireación Inox. 600 mm / Stell trim 600 mm	9900424
Rejilla aireación blanca 600 mm / White trim 600 mm	9900425
Rejilla aireación Inox. 900 mm / Stell trim 900 mm	9902883
Rejilla aireación blanca 900 mm / White trim 900 mm	9903453

REJILLA TABICA INDUCCION / Induction ventilation grill**■ CARACTERÍSTICAS TÉCNICAS:**

Rejilla de ventilación para placas de inducción.
Alturas: 20 y 32 mm. Disponibles en anchos 600 y 900 mm.
Acabado: Acero inoxidable.

■ FEATURES:

Ventilation grill for induction hobs.
Heights: 20 and 32 mm. Available in widths of 600 and 900 mm.
Finish: Stainless steel.



DESCRIPCIÓN Description	CÓDIGO Code
Rejilla inducción 20x600 mm / Ventilation grill 20x600 mm	9904022
Rejilla inducción 32x600 mm / Ventilation grill 32x600 mm	9904023
Rejilla inducción 20x900 mm / Ventilation grill 20x900 mm	9904025
Rejilla inducción 32x900 mm / Ventilation grill 32x900 mm	9904024

PROTECTOR FONDO PARA MODULOS FREGADEROS / Standalone washbasin cover**■ CARACTERÍSTICAS TÉCNICAS:**

Protector en aluminio texturizado o acero inox para bases de módulos fregaderos.

Para módulos estandar de 580 mm de profundidad y 16 mm grosor.
Pliegue en parte frontal. Con perfil antihumedad en laterales y trasera (tres lados)

Acabado en anodizado anticorrosión.

■ FEATURES:

Textured aluminium and stainless steel cover for the base of a standalone washbasin

For standard units 580 mm deep. 16 mm thick.
Upward-folder front piece. Anti-moisture profile on sides and back (three sides).

Anodised, anti-corrosive finish.

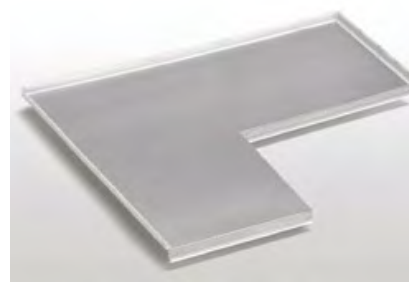

DESCRIPCIÓN Description	CÓDIGO Code
Protector aluminio módulo 450 / Aluminium unit cover 450	9901151
Protector aluminio módulo 500 / Aluminium unit cover 500	9901152
Protector aluminio módulo 600 / Aluminium unit cover 600	9901153
Protector aluminio módulo 700 / Aluminium unit cover 700	9901154
Protector aluminio módulo 800 / Aluminium unit cover 800	9901155
Protector aluminio módulo 900 / Aluminium unit cover 900	9901156
Protector aluminio módulo 1000 / Aluminium unit cover 1000	9901157
Protector aluminio rincón L 930x930 / L corner cover 930x930	9901159
Protector aluminio rincón L 1030x1030 / L corner cover 1030x1030	9901160
Protector acero inox. módulo 450 / Stainless sttel unit cover 450	9908800
Protector acero inox. módulo 500 / Stainless sttel unit cover 500	9908801
Protector acero inox. módulo 600 / Stainless sttel unit cover 600	9908802
Protector acero inox. módulo 700 / Stainless sttel unit cover 700	9908803
Protector acero inox. módulo 800 / Stainless sttel unit cover 800	9908804
Protector acero inox. módulo 900 / Stainless sttel unit cover 900	9908805
Protector acero inox. módulo 1000 / Stainless sttel unit cover 1000	9908806

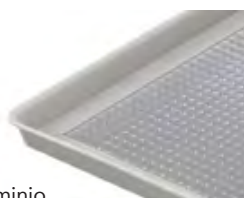

Acabado aluminio



Acabado inox



Pliegue central

PROTECTOR PARA COSTADOS LATERALES / Side cover

■ CARACTERÍSTICAS TÉCNICAS:

Juego 2 protectores en aluminio para costados de modulos altos y profundidad 330 mm.

Terminación: 2 pliegues. Alturas: 270, 700 y 900 mm.

Acabados: Inox y blanco.

■ FEATURES:

Set of 2 aluminium covers for the sides of hingh units with a depth of 330 mm.

Two-fold version available. Heights: 270, 700 and 900 mm.

Finishes: Stainless steel and white.

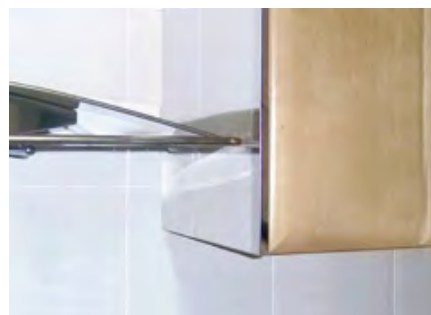

DESCRIPCIÓN <i>Description</i>	CÓDIGO <i>Code</i>
Juego 2 pliegues Inox 270 mm / Set 2 folds steel 270 mm	9900438
Juego 2 pliegues Inox 700 mm / Set 2 folds steel 700 mm	9903517
Juego 2 pliegues Inox 900 mm / Set 2 folds steel 900 mm	9903515
Juego 2 pliegues blanco 270 mm / Set 2 folds white 270 mm	9900437
Juego 2 pliegues blanco 700 mm / Set 2 folds white 700 mm	9903516
Juego 2 pliegues blanco 900 mm / Set 2 folds white 900 mm	9903518

PROTECTOR CANTO COSTADO DECORATIVO / Strip for side panel

■ CARACTERÍSTICAS TÉCNICAS:

Cubre canto protector para costados decorativos.

Para grosores de 19 y 21 mm. Medidas: 20x620 mm (alto x largo)

Acabado: Acero cepillado.

■ FEATURES:

Protector covers for decorative edge sides.

For thicknesses of 19 and 21 mm. Dimensions: 20x620 mm (height x lenght).

Finish: Brushed steel.



DESCRIPCIÓN <i>Description</i>	CÓDIGO <i>Code</i>
Protector canto costado 19 mm / Strip side panel 19 mm	9904390
Protector canto costado 21 mm / Strip side panel 21 mm	9904389

KIT PROTECTOR CANTO COSTADO DECORATIVO / Kit strip for side panel

■ CARACTERÍSTICAS TÉCNICAS:

Kit de perfiles en aluminio y niveladores para costados decorativos a suelo.

Para grosores de 19 y 21 mm. Medidas: 20x650 mm (alto x largo)

Acabado en aluminio plata.

■ FEATURES:

Kit of aluminum profiles and levelers for decorative sides to the floor.

For thicknesses of 19 and 21 mm. Measurements: 20x650 mm (height x leng)

Silver aluminium finish.



DESCRIPCIÓN <i>Description</i>	CÓDIGO <i>Code</i>
Kit protector a suelo 19 mm / Floor protector kit 19 mm	9909718
Kit protector a suelo 21 mm / Floor protector kit 21 mm	9910435

NIVELADOR PARA COSTADO CON REGULACIÓN / Leveler with regulation**■ CARACTERÍSTICAS TÉCNICAS:**

Nivelador de costado decorativo para embutir \varnothing 8 mm.
Acabado níquel mate. Pié exagonal nylon.

■ FEATURES:

Decorative side leveler for drawing \varnothing 8 mm.
Matte nickel finish. Nylon exagonal foot.



DESCRIPCIÓN Description	CÓDIGO Code
Nivelador para costado con regulación / Leveler with regulation	9906166

PATA PARA MOSTRADOR REGULABLE / Adjustable display case leg**■ CARACTERÍSTICAS TÉCNICAS:**

Pata metálica cilíndrica para soporte de mostrador, con pie para regulación hasta 30 mm.
Medidas: \varnothing 60 mm. Alturas: 830 y 870 mm.

■ FEATURES:

Cylindrical metal leg for a display case, with an adjustable foot up to 30 mm.
Measurements: \varnothing 60 mm. Heights 830 and 870 mm.
Finishes: Shiny chrome and matte chrome.

DESCRIPCIÓN Description	CÓDIGO Code
Pata mostrador cromo brillo 830 mm / Shiny chrome 830 mm	9900431
Pata mostrador cromo mate 830 mm / Matte chrome 830 mm	9900432
Pata mostrador gris RAL 9006 870 mm / Grey RAL 9006 870 mm	9908296

**PATA DECORATIVA CUADRADA / Decorative square leg****■ CARACTERÍSTICAS TÉCNICAS:**

Pata decorativa cuadrada de 40x40 mm. en aluminio, con base en gris para atornillar directamente al módulo. Pié con regulación.
Alturas estándar: 140 y 180 mm.
Acabado en Aluminio mate.

■ FEATURES:

Decorative 40x40 mm square leg aluminium, with grey base for mounting directly to the unit. Adjustable foot.
Standard heights: 140 and 180 mm.
Matte aluminium finish.

DESCRIPCIÓN Description	CÓDIGO Code
Pata cuadrada decorativa 140 mm / Square leg 140 mm	9901349
Pata cuadrada decorativa 180 mm / Square leg 180 mm	9901350

**SOPORTE PARA ESTANTES PELICANO / Pelicano shelf bracket****■ CARACTERÍSTICAS TÉCNICAS:**

Soporte Pelicano regulable para estantes de 5 a 40 mm. de grosor.
Regulación mediante tornillo en parte baja del soporte.
El soporte incluye tacos nylon y tornillos para fijación. Acabado cromo mate.

■ FEATURES:

Adjustable pelican bracket for shelves with a thickness of 5 to 40 mm.
Adjusts using a screw in the bottom part of the bracket.
Includes nylon caps and mounting screws. Matte chrome finish.

DESCRIPCIÓN Description	CÓDIGO Code
Soporte pelicano cromo / Pelican bracket chrome	9900433



SISTEMA DE PERSIANA METALLIC-LINE C-3 / Metallic-line C-3 metal tambour door system

■ **CARACTERÍSTICAS TÉCNICAS:**

Kit persiana de montaje por tambor Metallic-Line C-3, que incluye todos los componentes necesarios para el montaje en el módulo. Para grosores de costados en 16 mm.

Ancho de lamas: 20 mm.

Acabado: Aluminio.

■ **FEATURES:**

Metallic-Line C-3 metal tambour door kit, which includes all necessary for assembly in the cabinet. For side thicknesses of 16 mm. Slat width: 20 mm. Finish: Aluminium.



DESCRIPCIÓN <i>Description</i>	CÓDIGO <i>Code</i>
Metallic C-3 aluminio 1500x600 mm / C-3 aluminium 1500x600 mm	9900412
Metallic C-3 aluminio 1500x900 mm / C-3 aluminium 1500x900 mm	9900413



SISTEMA DE PERSIANA METALLIC-LINE C-BOX / Metallic-line C-Box metal tambour door system

■ **CARACTERÍSTICAS TÉCNICAS:**

Kit persiana de montaje sencillo mediante sujeción por cassette Metallic-Line C-BOX, que incluye todos los componentes necesarios para el montaje en el módulo.

Para grosores de costados en 16 mm.

Ancho de lamas: 25 mm.

Acabados: Aluminio y acero inox.

■ **FEATURES:**

Metallic-Line C-BOX tambour door kit. Easy to mount by fastening the cassette.

Includes all necessary parts for assembly in the cabinet.

For side thicknesses of 16 mm. Slat width: 25 mm.

Finishes: Aluminium and stainless steel.



DESCRIPCIÓN <i>Description</i>	CÓDIGO <i>Code</i>
Metallic C-BOX aluminio 1500x600 mm / C-BOX aluminium 1500x600	9900417
Metallic C-BOX aluminio 1500x900 mm / C-BOX aluminium 1500x900	9900418
Metallic C-BOX acero inox 1500x600 mm / C-BOX steel 1500x600	9900420
Metallic C-BOX acero inox 1500x900 mm / C-BOX steel 1500x900	9900421



SISTEMA DE PERSIANA VETRO-LINE CRISTAL / Vetro-line cristal glass tambour door system**■ CARACTERÍSTICAS TÉCNICAS:**

Kit persiana de montaje sencillo mediante sujeción por cassette Vetro-Line cristal, que incluye todos los componentes necesarios para el montaje en el módulo

Para grosores de costados en 16 mm.

Ancho de lamas: cristal de seguridad 50 mm.

Acabados: Translúcido, Negro y Blanco.

■ FEATURES:

Vetro-Line Cristal glass tambour door kit. Easy to mount by fastening the cassette.

Includes all necessary parts for assembly in the cabinet.

For side thicknesses of 16 mm. Slat width: 50 mm safety glass.

Finishes: Translucent, black, and white.



DESCRIPCIÓN <i>Description</i>	CÓDIGO <i>Code</i>
Vetro-Line translúcido 1500x600 mm / <i>Vetro-line transluc.1500x600</i>	9900402
Vetro-Line translúcido 1500x900 mm / <i>Vetro-line transluc.1500x900</i>	9900404
Vetro-Line negro 1500x600 mm / <i>Vetro-line black 1500x600 mm</i>	9900406
Vetro-Line negro 1500x900 mm / <i>Vetro-line black 1500x900 mm</i>	9900408
Vetro-Line blanco 1500x600 mm / <i>Vetro-line white 1500x600 mm</i>	9903460
Vetro-Line blanco 1500x900 mm / <i>Vetro-line white 1500x900 mm</i>	9903461

SISTEMA DE PERSIANA BASIC / Basic tambour door system**■ CARACTERÍSTICAS TÉCNICAS:**

Kit persiana de montaje por tambor Basic que incluye todos los componentes

necesarios para el montaje en el módulo. De fácil adaptación en anchura.

Para grosores de costados en 16 mm. Ancho de lamas: 35 mm.

Acabados: ABS en aluminio inox y colores super-mate.

■ FEATURES:

Basic tambour door kit which includes all necessary parts for assembly in the cabinet.

Easily adaptable in width.

For side thicknesses of 16 mm. Slat width: 35 mm.

Finishes: ABS in steel aluminium and supermatt colors.

DESCRIPCIÓN <i>Description</i>	CÓDIGO <i>Code</i>
Basic ABS Inox 1500x600 mm / <i>Basic steel aluminium 1500x600 mm</i>	9907140
Basic ABS Inox 1500x900 mm / <i>Basic steel aluminium 1500x900 mm</i>	9902788
Basic ABS PEM-055 SP 1500x600 mm / <i>Basic PEM-055 1500x600 mm</i>	9907209
Basic ABS PEM-056 SP 1500x600 mm / <i>Basic PEM-056 1500x600 mm</i>	9907210
Basic ABS PEM-057 SP 1500x600 mm / <i>Basic PEM-057 1500x600 mm</i>	9907211
Basic ABS PEM-058 SP 1500x600 mm / <i>Basic PEM-058 1500x600 mm</i>	9907212
Basic ABS PEM-060 SP 1500x600 mm / <i>Basic PEM-060 1500x600 mm</i>	9905164
Basic ABS PEM-061 SP 1500x600 mm / <i>Basic PEM-061 1500x600 mm</i>	9907214
Basic ABS PEM-063 SP 1500x600 mm / <i>Basic PEM-063 1500x600 mm</i>	9907216
Basic ABS PEM-064 SP 1500x600 mm / <i>Basic PEM-064 1500x600 mm</i>	9905166



KIT FOCO DE SUPERFICIE LED L 160.150 / Kit LED focus surface L 160.150

■ CARACTERÍSTICAS TÉCNICAS:

Foco LED ultrafino en aluminio de alta luminosidad equipado con 12 LED SAMSUNG.

No necesita mecanizado para su instalación. Medidas: 150x65x4 mm.

Color K luz blanco 5000. Angulo luz 170°. Lumens: 480. Potencia: 5w/12v.

Kit compuesto de: foco LED, transformador, dimmer touch remoto de regulación 0-100, cable de prolongación y caja de conexión.

■ FEATURES:

Focus LED ultra-thin aluminum equipped with high brightness 12 LED SAMSUNG.

No need machining installation.

Dimensions: 150x65x4 mm. Color K light white light 5000. Angle 170° degrees.

Lumens: 480. Power: 5w/12v.

Kit consisting of: LED bulb, transformer, dimmer control touch on, extension cable and connectio box.

DESCRIPCIÓN Description	CÓDIGO Code
Kit 1 Foco LED L160.150 / Kit LED 1 focus L160.150	9906013
Kit 2 Focos LED L160.150 / Kit LED 2 focus L160.150	9906014
Kit 3 Focos LED L160.150 / Kit LED 3 focus L160.150	9906015
Kit 4 Focos LED L160.150 / Kit LED 4 focus L160.150	9906016
Kit 5 Focos LED L160.150 / Kit LED 5 focus L160.150	9906017



KIT FOCO DE SUPERFICIE LED L 161.62s / Kit LED focus surface L 161.62s

■ CARACTERÍSTICAS TÉCNICAS:

Foco LED en aluminio negro de alta luminosidad equipado con 1 LED COB.

No necesita mecanizado para su instalación. Medidas: 62x62x12 mm.

Color K luz blanco 4000. Angulo luz 120°. Lumens: 240. Potencia: 3w/12v.

Kit compuesto de: foco LED, transformador, dimmer touch remoto de regulación 0-100, cable de prolongación y caja de conexión.

■ FEATURES:

Focus LED black aluminum equipped with high brightness 1 LED COB. No need machining installation.

Dimensions: 62x62x12 mm. Color K light white light 4000. Angle 120° degrees.

Lumens: 240. Power: 3w/12v.

Kit consisting of: LED bulb, transformer, dimmer control touch on, extension cable and connectio box.

DESCRIPCIÓN Description	CÓDIGO Code
Kit 1 Foco LED L161.62s / Kit LED 1 focus L161.62s	9910447
Kit 2 Focos LED L161.62s / Kit LED 2 focus L161.62s	9910448
Kit 3 Focos LED L161.62s / Kit LED 3 focus L161.62s	9910449
Kit 4 Focos LED L161.62s / Kit LED 4 focus L161.62s	9910450

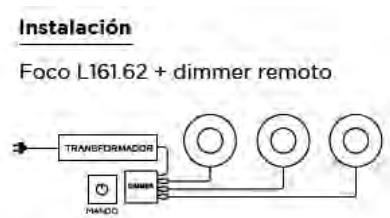

PERFIL LED DE SUPERFICIE L 203 / LED profile of surface L 203**■ CARACTERÍSTICAS TÉCNICAS:**

Perfil LED de superficie de alta intensidad lumínica sin puntos led. Incorpora Sensor Touch táctil on-off y conector de cable.

Medidas: 400x28x17 mm. N° led 48. Color blanco 4000. Angulo luz 120°. Lumens: 520. Potencia: 5w/12v.

Medidas: 600x28x17 mm. N° led 72. Color blanco 4000. Angulo luz 120°. Lumens: 780. Potencia: 7w/12v.

Medidas: 900x28x17 mm. N° led 108. Color blanco 4000. Angulo luz 120°. Lumens: 1170. Potencia: 11w/12v.

Medidas: 1200x28x17 mm. N° led 144. Color blanco 4000. Angulo luz 120°. Lumens: 1560. Potencia: 15w/12v.

Nota de pedido: transformador LED se tiene que pedir por separado.

■ FEATURES:

LED profile of high intensity light surface without led points. It incorporates Touch-on-off touch sensor and cable connector.

Measures: 400x28x17 mm. N° led 48. White color 4000. Light angle 120°. Lumens: 520. Power: 5w / 12v

Measures: 600x28x17 mm. N° led 72. White color 4000. Light angle 120°. Lumens: 780. Power: 7w / 12v.

Measures: 900x28x17 mm. N° led 108. White color 4000. Light angle 120°. Lumens: 1170. Power: 11w / 12v

Measures: 1200x28x17 mm. N° led 144. White color 4000. Light angle 120°. Lumens: 1560. Power: 15w / 12v.

Ordering information: LED transformer must be ordered separately.

DESCRIPCIÓN Description	CÓDIGO Code
Perfil LED L 203 400 mm / L 203 profile 400 mm	9908318
Perfil LED L 203 600 mm / L 203 profile 600 mm	9908319
Perfil LED L 203 900 mm / L 203 profile 900 mm	9908320
Perfil LED L 203 1200 mm / L 203 profile 1200 mm	9908321
Transformador LED 36w / Transformer 36w LED	9908322

Instalación regleta L203 + transformador

El perfil se instala con tornillos en las tapas (incluidos)

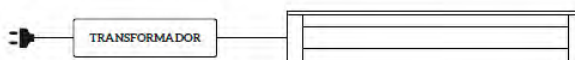

REGLETA DE SUPERFICIE LED RUNNER / RUNNER LED surface light

■ CARACTERÍSTICAS TÉCNICAS:

Perfil 47x47 mm. con proyección oblicua de la luz LED RUNNER.

Para montaje formando escuadra entre la base del módulo alto y la pared. Fijación a módulo mediante clips suministrados en el embalaje.

Integra tecnología HE, alta densidad de diodos que elimina la percepción de los puntos leds. Incorpora sensor Touch con el que encender y apagar el Runner. Con de cable de conexión de 2 metros. Posibilidad de conectar varios entre si.

600 mm. Consumo 5,5w. Luz blanco natural. Temperatura de color 4300 k.

900 mm. Consumo 8,4w. Luz blanco natural. Temperatura de color 4300 k.

Acabado: difusor metacrilato blanco.

Nota de pedido: transformador LED se tiene que pedir por separado.

■ FEATURES:

Profile 47x47 mm. with oblique projection of the RUNNER LED light.

For mounting in a square between the base of the tall module and the wall. Fixing to the module by means of clips supplied in the packaging.

It integrates HE technology, high diode density that eliminates the perception of the LED spots. It incorporates a Touch sensor with which to light and turn off the Runner. With 2 meter connection cable. Possibility of connecting several to each other.

600 mm. Consumption 5.5w. Natural white light. Color temperature 4300 k.

900 mm. Consumption 8.4w. Natural white light. Color temperature 4300 k.

Finish: white methacrylate diffuser.

Ordering information: LED transformer must be ordered separately.

DESCRIPCIÓN Description	CÓDIGO Code
Perfil Runner 600 con interruptor / Runner 600 profile with switch	9907119
Perfil Runner 900 con interruptor / Runner 900 profile with switch	9907953
Transformador 15w LED RUNNER / 15w LED RUNNER transformer	9907120
Transformador 30w LED RUNNER / 30w LED RUNNER transformer	9907954



TORRE ELECTRIFICADA OCULTA / Hidden electrified tower

■ CARACTERÍSTICAS TÉCNICAS:

Torre electrificada para ocultar en la encimera con hueco encastre \varnothing 60 mm. 230v 50hz. Con 3 tomas de corriente y 2 puertos USB. Altura torre 310 mm.

■ FEATURES:

Electrified tower to hide on the worktop with hollow \varnothing 60 mm.

230v 50hz With 3 sockets and 2 USB ports. Tower height 310 mm.

DESCRIPCIÓN Description	CÓDIGO Code
Torre electrificada oculta / Hidden electrified tower	9909023



D.

CAJONES Y CACEROLEROS

Drawers and pan drawers



TOP FORM

KIT CAJÓN METÁLICO COMPLETO GRIS / Complete grey metal drawer kit**■ CARACTERÍSTICAS TÉCNICAS:**

Kit cajón completo metálico gris. Carga máxima 25 kg.
 Incluye: conjunto de laterales metálicos, juego de guías correderas, enganches frontales metálico con regulación, fondo y trasera en melamina 16 mm grosor.
 Alturas 86 y 118 mm. Fondo 500 mm.
 Acabado gris RAL 7042.

■ FEATURES:

Complete grey metal drawer kit. Maximum load 25 kg.
 Includes: set of metal side pieces, set of sliding guides, adjustable metal front hooks, 16 mm thick melamine bottom and back pieces.
 Heights 86 and 118 mm. Depths 500 mm.
 RAL 7042 grey finish.



ALTO mm Height mm	MÓDULO Cabinet	CÓDIGO Code
86	300	9900827
86	350	9900828
86	400	9900829
86	450	9900830
86	500	9900831
86	600	9900832
86	700	9900833
86	800	9900834
86	900	9900835

ALTO mm Profile	MÓDULO Cabinet	CÓDIGO Code
118	300	9900838
118	350	9900839
118	400	9900840
118	450	9900841
118	500	9900842
118	600	9900843
118	700	9900844
118	800	9900845
118	900	9900846

KIT CACEROLERO METÁLICO COMPLETO GRIS / Complete grey metal pan drawer kit**■ CARACTERÍSTICAS TÉCNICAS:**

Kit cacerolero completo metálico gris. Carga máxima 25 kg.
 Incluye: conjunto de laterales metálicos, juego de guías correderas, enganches frontales metálico con regulación, juego cercos rectangular, fondo y trasera en melamina 16 mm grosor.
 Altura 150 mm + cercos rectangulares: 220 mm. Fondo 500 mm.
 Acabado gris RAL 7042.

■ FEATURES:

Complete grey metal drawer kit. Maximum load 25 kg.
 Includes: set of metal side pieces, set of sliding guides, set of rectangular enclosures, adjustable metal front hooks and 160 mm thick melamine bottom and back pieces.
 Height 150 mm + rectangular enclosures, total: 220 mm. Depth 500 mm.
 RAL 7042 grey finish.



ALTO mm Height mm	MÓDULO Cabinet	CÓDIGO Code
220	300	9900860
220	350	9900861
220	400	9900862
220	450	9900863
220	500	9900864
220	600	9900865
220	700	9900866
220	800	9900867
220	900	9900868

KIT LATERALES CAJÓN METALICO GRIS / Grey metal drawer side piece kit

■ CARACTERÍSTICAS TÉCNICAS:

Kit laterales cajón metálico gris.
 Incluye: conjunto de laterales metálicos, juego de guías correderas y enganches frontales metálico con regulación.
 Alturas: 54, 86 y 118 mm. Fondos: 300, 400 y 500 mm.
 Acabado gris RAL 7042.



■ FEATURES:

Side kit for grey metal drawers.
 Includes: set of metal side pieces, set of sliding guides and adjustable metal front hooks.
 Heights: 54, 86 and 118 mm. Depths: 300, 400 and 500 mm.
 RAL 7042 grey finish.

ALTO mm Height mm	FONDO mm Depth mm	CÓDIGO Code
86	300	9900508
86	400	9900512
86	500	9900518
118	400	9900513
118	500	9900519

FONDO Y TRASERA MELAMINA CAJÓN METÁLICO / Melamine bottom and back pieces for metal drawer

■ CARACTERÍSTICAS TÉCNICAS:

Fondo y trasera en melamina de 16 mm grosor para cajón metálico de 500 mm de profundidad.

■ FEATURES:

Melamine bottom and back piece 16 mm. thick, for metal drawers with 500 mm depth.



ALTO mm Height mm	MÓDULO Cabinet	CÓDIGO Code
86	300	9901945
86	350	9901946
86	400	9901947
86	450	9901948
86	500	9901949
86	600	9901950
86	700	9901951
86	800	9901952
86	900	9901953

ALTO mm Height mm	MÓDULO Cabinet	CÓDIGO Code
118	300	9901956
118	350	9901957
118	400	9901958
118	450	9901959
118	500	9901960
118	600	9901961
118	700	9901962
118	800	9901963
118	900	9901964

KIT LATERALES CACEROLERO METALICO GRIS / Grey metal pan drawer side piece kit**■ CARACTERÍSTICAS TÉCNICAS:**

Kit laterales cacerolero metálico gris.

Incluye: conjunto de laterales metálicos, juego de guías correderas y enganches frontales metálico con regulación.

Altura: 150 mm. Fondos: 400 y 500 mm.

Acabado gris RAL 7042.

■ FEATURES:

Side kit for grey metal pan drawers.

Includes: set of metal side pieces, set of sliding guides and adjustable metal front hooks. Height: 150 mm. Depths: 400 and 500 mm.

RAL 7042 grey finish.



ALTO mm Height mm	FONDO mm Depth mm	CÓDIGO Code
150	400	9900514
150	500	9900520

KIT CERCO CACEROLERO METÁLICO / Metal pan drawer enclosure kit**■ CARACTERÍSTICAS TÉCNICAS:**

Conjunto de tubos y cogidas rectangulares para formar cacerolero metálico junto al kit de laterales. Profundidad 500 mm.

Acabado gris RAL 7042.

■ FEATURES:

Set of rectangular rods and brackets to create metal pan drawer together with the metal side piece kit. Depth available 500 mm.

RAL 7042 grey finish.



DESCRIPCIÓN Description	CÓDIGO Code
Kit cerco rectangular / Rectangular enclosure kit	9900522

FONDO Y TRASERA MELAMINA CACEROLERO METÁLICO / Melamine bottom and back pieces for metal pan drawer**■ CARACTERÍSTICAS TÉCNICAS:**

Fondo y trasera en melamina de 16 mm grosor para cacerolero metálico de 500 mm de profundidad.

■ FEATURES:

Melamine bottom and back piece 16 mm. thick, for metal pan drawers with 500 mm depth.



ALTO mm Height mm	MÓDULO Cabinet	CÓDIGO Code
220	300	9901967
220	350	9901968
220	400	9901969
220	450	9901970
220	500	9901971
220	600	9901972
220	700	9901973
220	800	9901974
220	900	9901975

KIT AUTOCIERRE PARA CAJÓN METÁLICO GRIS / Automatic closing kit for grey metal drawers

■ CARACTERÍSTICAS TÉCNICAS:

Kit autocierre para cajón metálico gris.

Incluye: 2 mecanismos autocierre izquierda / derecha y pins para fijación en el lateral cajón metálico.

Acabado en ABS.

■ FEATURES:

Automatic closing kit for grey metal drawers.

Kit includes: 2 automatic closing mechanisms left / right and pins for mounting on the metal drawer side pieces.

ABS finish.

DESCRIPCIÓN Description	CÓDIGO Code
Kit autocierre cajón metalico / Automatic closing kit	9902764



Detalle del kit autocierre
Detailed views of automatic closing kit

CUBERTERO PARA CAJÓN METÁLICO GRIS / Organiser for grey metal drawers

■ CARACTERÍSTICAS TÉCNICAS:

Cubertero ajustado en los cuatro lados para cajón metálico gris.

Solo para cajones de 500 mm de profundidad.

Acabado en ABS gris satinado.

■ FEATURES:

Close-fitting organiser for grey metal drawer.

Only for drawers measuring 500 mm. in depth.

ABS finish satin grey.



DESCRIPCIÓN Description	CÓDIGO Code
Cubertero cajón metálico 300 mm / Organiser 300 mm	9900944
Cubertero cajón metálico 350 mm / Organiser 350 mm	9900945
Cubertero cajón metálico 400 mm / Organiser 400 mm	9900946
Cubertero cajón metálico 450 mm / Organiser 450 mm	9900947
Cubertero cajón metálico 500 mm / Organiser 500 mm	9900948
Cubertero cajón metálico 600 mm / Organiser 600 mm	9900949
Cubertero cajón metálico 700 mm / Organiser 700 mm	9900950
Cubertero cajón metálico 800 mm / Organiser 800 mm	9900951
Cubertero cajón metálico 900 mm / Organiser 900 mm	9900952

KIT CAJÓN COMPLETO EUROBOX ACERO GRIS / BLANCO*Eurobox grey steel or white complete drawer kit***■ CARACTERÍSTICAS TÉCNICAS:**

Kit cajón completo Eurobox acero gris o blanco. Carga máxima 40 kg.

Incluye: juego de guías correderas de extracción total y autocierre silencioso, juego laterales en acero, enganches frontales con regulación, soportes para trasera, fondo y trasera en melamina de 16 mm grosor. Altura 70 mm. Fondo 500 mm.

Acabado en gris y blanco.

■ FEATURES:

Eurobox grey steel or white complete drawer kit. Maximum load 40 kg.

Includes: set of completely removable sliding guides that automatically close silently, set of side pieces, adjustable front hooks, supports for back piece and melamine back and bottom pieces measuring 16 mm in thickness.

Height 70 mm. Depth 500 mm.

Finish grey and white.



ACABADO Finish	ALTO mm Height mm	MÓDULO Cabinet	CÓDIGO Code
Gris / Grey	70	300	9900581
Gris / Grey	70	350	9900582
Gris / Grey	70	400	9900583
Gris / Grey	70	450	9900584
Gris / Grey	70	500	9900585
Gris / Grey	70	600	9900586
Gris / Grey	70	700	9900587
Gris / Grey	70	800	9900588
Gris / Grey	70	900	9900589
Gris / Grey	70	1000	9900590

ACABADO Finish	ALTO mm Height mm	MÓDULO Cabinet	CÓDIGO Code
Blanco / White	70	300	9907693
Blanco / White	70	350	9907694
Blanco / White	70	400	9907695
Blanco / White	70	450	9907696
Blanco / White	70	500	9907697
Blanco / White	70	600	9907698
Blanco / White	70	700	9907699
Blanco / White	70	800	9907700
Blanco / White	70	900	9907701
Blanco / White	70	1000	9907702

Montaje Mínimo Requerido

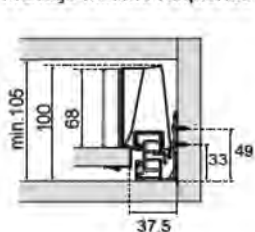

Montaje Frontal

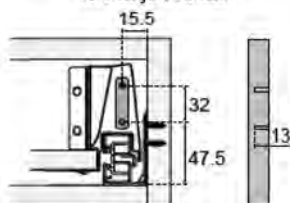

Montaje Trasero

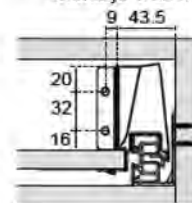

KIT CACEROLERO COMPLETO EUROBOX ACERO GRIS / BLANCO ALTURA 152 mm.

Eurobox grey steel or white complete pan drawer kit 152 mm height

■ CARACTERÍSTICAS TÉCNICAS:

Kit cacerolero completo Eurobox acero gris o blanco.
Carga máxima 40 kg.
Incluye: juego de guías correderas de extracción total y autocierre silencioso, juego laterales en acero, set barras simple, enganches frontales con regulación, soportes para trasera, fondo y trasera en melamina de 16 mm grosor.
Altura 152 mm. Fondo 500 mm.
Acabado en gris y blanco.

■ FEATURES:

Eurobox grey steel or white complete pan drawer kit.
Maximum load 40 kg.
Includes: set of completely removable sliding guides that automatically close silently, set of grey steel or white side pieces, set of single rods, adjustable front hooks, supports for back piece, melamine back and bottom pieces measuring 16 mm in thickness.
Height 152 mm. Depth 500 mm.
Finish grey and white.

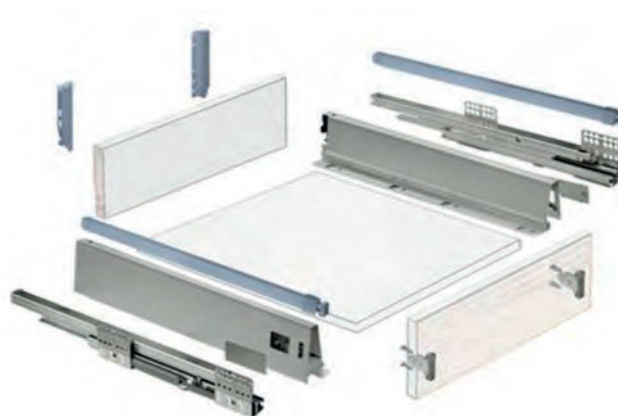

ACABADO Finish	ALTO mm Height mm	MÓDULO Cabinet	CÓDIGO Code
Gris / Grey	152	300	9900660
Gris / Grey	152	350	9900661
Gris / Grey	152	400	9900662
Gris / Grey	152	450	9900663
Gris / Grey	152	500	9900664
Gris / Grey	152	600	9900665
Gris / Grey	152	700	9900666
Gris / Grey	152	800	9900667
Gris / Grey	152	900	9900668
Gris / Grey	152	1000	9900669

ACABADO Finish	ALTO mm Height mm	MÓDULO Cabinet	CÓDIGO Code
Blanco / White	152	300	9907703
Blanco / White	152	350	9907704
Blanco / White	152	400	9907705
Blanco / White	152	450	9907706
Blanco / White	152	500	9907707
Blanco / White	152	600	9907708
Blanco / White	152	700	9907709
Blanco / White	152	800	9907710
Blanco / White	152	900	9907711
Blanco / White	152	1000	9907712

Montaje Mínimo Requerido

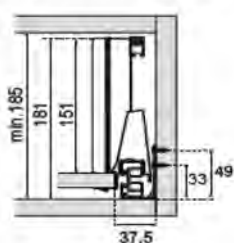

Montaje Frontal

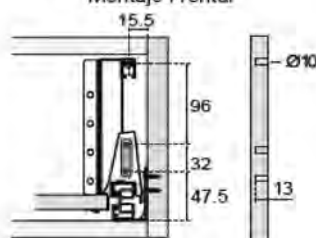

Montaje Trasero

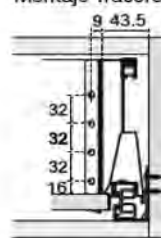

KIT CACEROLERO COMPLETO EUROBOX ACERO GRIS / BLANCO ALTURA 184 mm.

Eurobox grey steel or white complete pan drawer kit 184 mm height

■ CARACTERÍSTICAS TÉCNICAS:

Kit cacerolero completo Eurobox acero gris o blanco.
Carga máxima 40 kg.

Incluye: juego de guías correderas de extracción total y autocierre silencioso, juego laterales en acero, set barras simple, enganches frontales con regulación, soportes para trasera, fondo y trasera en melamina de 16 mm grosor.

Altura 184 mm. Fondo 500 mm.

Acabado en gris y blanco.

■ FEATURES:

Eurobox grey steel or white complete pan drawer kit.
Maximum load 40 kg.

Includes: set of completely removable sliding guides that automatically close silently, set of grey steel or white side pieces, set of single rods, adjustable front hooks, supports for back piece, melamine back and bottom pieces measuring 16 mm in thickness.

Height 184 mm. Depth 500 mm.

Finish grey and white.

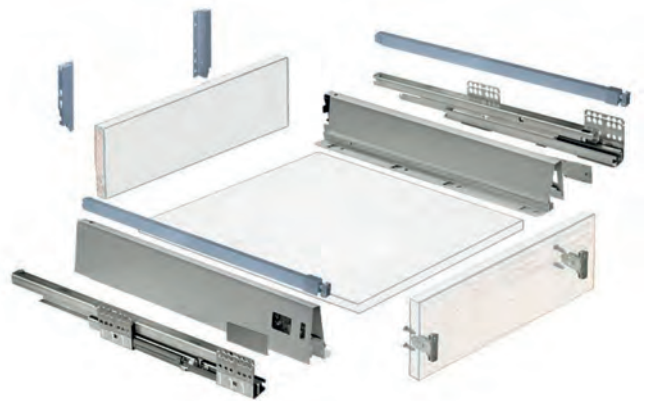

ACABADO Finish	ALTO mm Height mm	MÓDULO Cabinet	CÓDIGO Code
Gris / Grey	184	300	9900728
Gris / Grey	184	350	9900729
Gris / Grey	184	400	9900730
Gris / Grey	184	450	9900731
Gris / Grey	184	500	9900732
Gris / Grey	184	600	9900733
Gris / Grey	184	700	9900734
Gris / Grey	184	800	9900735
Gris / Grey	184	900	9900736
Gris / Grey	184	1000	9900737

ACABADO Finish	ALTO mm Height mm	MÓDULO Cabinet	CÓDIGO Code
Blanco / White	184	300	9907713
Blanco / White	184	350	9907714
Blanco / White	184	400	9907715
Blanco / White	184	450	9907716
Blanco / White	184	500	9907717
Blanco / White	184	600	9907718
Blanco / White	184	700	9907719
Blanco / White	184	800	9907720
Blanco / White	184	900	9907721
Blanco / White	184	1000	9907722

Montaje Mínimo Requerido

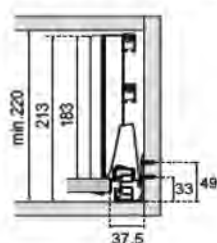

Montaje Frontal

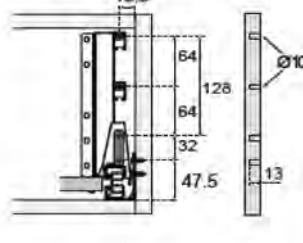

Montaje Trasero

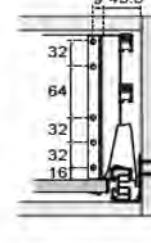

KIT CAJÓN INTERIOR ARMADO EUROBOX GRIS

Eurobox inside grey armed drawer kit

■ CARACTERÍSTICAS TÉCNICAS:

Kit cajón interior completo Eurobox gris. Carga máxima 40 kg. Incluye: juego de guías correderas de extracción total y autocierre silencioso, juego laterales en acero, frontal metálico, enganches frontales con regulación, soportes para trasera, fondo y trasera en melamina de 16 mm grosor. Altura 70 mm. Fondo 500 mm. Acabado gris.

■ FEATURES:

Eurobox inside grey complete drawer kit. Maximum load 40 kg. Includes: set of completely removable sliding guides that automatically close silently, set of side pieces, metal front piece, adjustable front hooks, supports for back piece and melamine back and bottom pieces measuring 16 mm in thickness. Height 70 mm. Depth 500 mm. Finish grey.

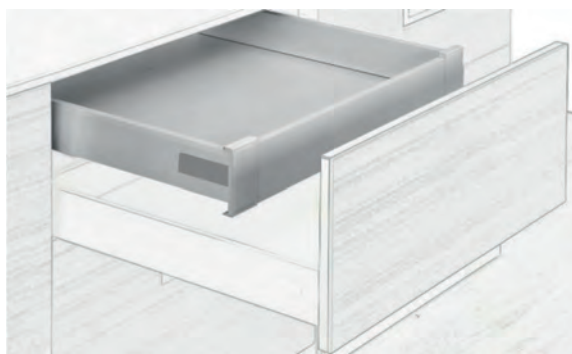

ACABADO Finish	ALTO mm Height mm	MÓDULO Cabinet	CÓDIGO Code
Gris / Grey	70	300	9909606
Gris / Grey	70	350	9909607
Gris / Grey	70	400	9909608
Gris / Grey	70	450	9909609
Gris / Grey	70	500	9909610
Gris / Grey	70	600	9909611
Gris / Grey	70	700	9909612
Gris / Grey	70	800	9909613
Gris / Grey	70	900	9909614

KIT CACEROLERO INTERIOR ARMADO EUROBOX GRIS

Eurobox inside grey armed pan drawer kit

■ CARACTERÍSTICAS TÉCNICAS:

Kit cacerolero interior completo Eurobox acero gris. Carga máxima 40 kg. Incluye: juego de guías correderas de extracción total y autocierre silencioso, juego laterales en acero, frontal metálico con barra, set barras simple, enganches frontales con regulación, soportes para trasera, fondo y trasera en melamina de 16 mm de grosor. Altura 184 mm. Fondo 500 mm. Acabado gris.

■ FEATURES:

Eurobox grey steel or white complete pan drawer kit. Maximum load 40 kg. Includes: set of completely removable sliding guides that automatically close silently, set of side pieces, meta front piece, set of single rods, adjustable front hooks, supports for back piece, melamine back and bottom pieces measuring 16 mm in thickness. Height 184 mm. Depth 500 mm. Finish grey.



ACABADO Finish	ALTO mm Height mm	MÓDULO Cabinet	CÓDIGO Code
Gris / Grey	184	300	9909616
Gris / Grey	184	350	9909617
Gris / Grey	184	400	9909618
Gris / Grey	184	450	9909619
Gris / Grey	184	500	9909620
Gris / Grey	184	600	9909621
Gris / Grey	184	700	9909622
Gris / Grey	184	800	9909623
Gris / Grey	184	900	9909624

KIT CAJÓN EUROBOX ACERO GRIS / BLANCO / Eurobox grey steel or white drawer kit**■ CARACTERÍSTICAS TÉCNICAS:**

Despiece para cajón Eurobox en acero gris o blanco.

Incluye: juego de guías correderas de extracción total y autocierre silencioso con capacidad de carga hasta 40 Kg, juego de laterales en acero, enganches frontales con regulación y soportes para trasera melamina de 16 mm grosor.

Altura 70 mm. Fondos 275, 400 y 500 mm.

Acabado en gris y blanco.

■ FEATURES:

Individual component Eurobox grey steel or white drawer kit.

Includes: set of completely removable sliding guides that close silently, with a maximum load weight of 40 kg, set of side pieces, adjustable front hooks, and supports for 16 mm thick melamine back piece.

Height: 70 mm. Depths: 275, 400 and 500 mm.

Finish grey and white.

ACABADO Finish	ALTO mm Height mm	FONDO mm Depth mm	CÓDIGO Code
Gris / Grey	70	275	9900523
Gris / Grey	70	400	9900524
Gris / Grey	70	500	9900525
Blanco / White	70	275	9907388
Blanco / White	70	400	9907389
Blanco / White	70	500	9907390

**SET SOPORTES TRASERA + BARRAS CACEROLERO EUROBOX ACERO GRIS / BLANCO ALTURA 152 mm.**

Set supports for rear + bars Eurobox grey steel or white pan drawer kit 152 mm height

■ CARACTERÍSTICAS TÉCNICAS:

Set 2 barras con enganches frontales y soportes para trasera melamina 16 mm grosor.

■ FEATURES:

Set 2 single bars and supports for 16 mm thick melamine back piece.

ACABADO Finish	ALTO mm Height mm	FONDO mm Depth mm	CÓDIGO Code
Gris / Grey	152	400	9902293
Gris / Grey	152	500	9902294
Blanco / White	152	400	9907393
Blanco / White	152	500	9907394

**SET SOPORTES TRASERA + BARRAS CACEROLERO EUROBOX ACERO GRIS / BLANCO ALTURA 184 mm.**

Set supports for rear + bars Eurobox grey steel or white pan drawer kit 184 mm height

■ CARACTERÍSTICAS TÉCNICAS:

Set 2 barras con enganches frontales y soportes para trasera melamina 16 mm grosor.

■ FEATURES:

Set 2 single bars and supports for 16 mm thick melamine back piece.

ACABADO Finish	ALTO mm Height mm	FONDO mm Depth mm	CÓDIGO Code
Gris / Grey	184	500	9902296
Blanco / White	184	500	9907398

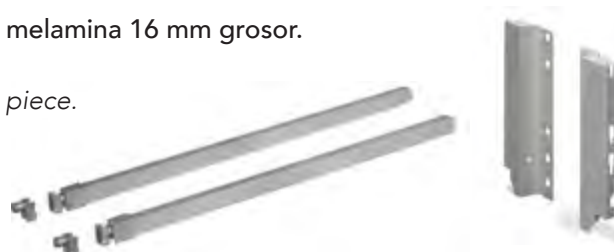
**■ CARACTERÍSTICAS TÉCNICAS:**

Set 4 barras con enganches frontales y soportes para trasera melamina 16 mm grosor.

■ FEATURES:

Set 4 single bars and supports for 16 mm thick melamine back piece.

ACABADO Finish	ALTO mm Height mm	FONDO mm Depth mm	CÓDIGO Code
Gris / Grey	184	500	9907957
Blanco / White	184	500	9907960

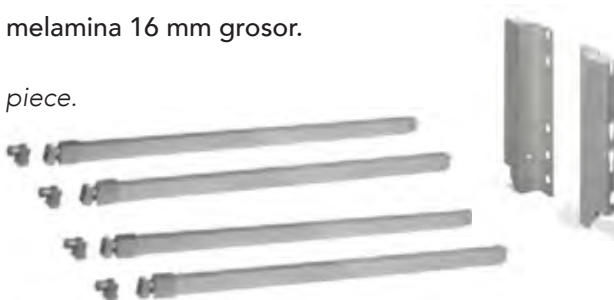

FONDO Y TRASERA MELAMINA PARA CAJÓN EUROBOX

Melamine bottom and back piece for Eurobox drawer

■ CARACTERÍSTICAS TÉCNICAS:

Fondo y trasera en melamina de 16 mm grosor para cajón Eurobox altura 70 mm y 500 mm profundidad.

■ FEATURES:

16 mm thick melamine bottom and back piece kit for Eurobox drawer with 70 mm height and 500 mm depth.



ACABADO Finish	MÓDULO Cabinet	CÓDIGO Code
Gris / Grey	300	9901978
Gris / Grey	350	9901979
Gris / Grey	400	9901980
Gris / Grey	450	9901981
Gris / Grey	500	9901982
Gris / Grey	600	9901983
Gris / Grey	700	9901984
Gris / Grey	800	9901985
Gris / Grey	900	9901986
Gris / Grey	1000	9901987

ACABADO Finish	MÓDULO Cabinet	CÓDIGO Code
Blanco / White	300	9907643
Blanco / White	350	9907644
Blanco / White	400	9907645
Blanco / White	450	9907646
Blanco / White	500	9907647
Blanco / White	600	9907648
Blanco / White	700	9907649
Blanco / White	800	9907650
Blanco / White	900	9907651
Blanco / White	1000	9907652

FONDO Y TRASERA MELAMINA PARA CACEROLERO EUROBOX

Melamine bottom and back piece for Eurobox pan drawer

■ CARACTERÍSTICAS TÉCNICAS:

Fondo y trasera en melamina de 16 mm grosor para caceroleros Eurobox altura 152 / 184 mm y 500 mm profundidad.

■ FEATURES:

16 mm thick melamine bottom and back piece kit for Eurobox pan drawers with 152 / 184 mm height and 500 mm depth.



ALTURA / Height 152 mm		
ACABADO Finish	MÓDULO Cabinet	CÓDIGO Code
Gris / Grey	300	9901989
Gris / Grey	350	9901990
Gris / Grey	400	9901991
Gris / Grey	450	9901992
Gris / Grey	500	9901993
Gris / Grey	600	9901994
Gris / Grey	700	9901995
Gris / Grey	800	9901996
Gris / Grey	900	9901997
Gris / Grey	1000	9901998

ALTURA / Height 152 mm		
ACABADO Finish	MÓDULO Cabinet	CÓDIGO Code
Blanco / White	300	9907653
Blanco / White	350	9907654
Blanco / White	400	9907655
Blanco / White	450	9907656
Blanco / White	500	9907657
Blanco / White	600	9907658
Blanco / White	700	9907659
Blanco / White	800	9907660
Blanco / White	900	9907661
Blanco / White	1000	9907662

ALTURA / Height 184 mm		
ACABADO Finish	MÓDULO Cabinet	CÓDIGO Code
Gris / Grey	300	9902000
Gris / Grey	350	9902001
Gris / Grey	400	9902002
Gris / Grey	450	9902003
Gris / Grey	500	9902004
Gris / Grey	600	9902005
Gris / Grey	700	9902006
Gris / Grey	800	9902007
Gris / Grey	900	9902008
Gris / Grey	1000	9902009

ALTURA / Height 184 mm		
ACABADO Finish	MÓDULO Cabinet	CÓDIGO Code
Blanco / White	300	9907663
Blanco / White	350	9907664
Blanco / White	400	9907665
Blanco / White	450	9907666
Blanco / White	500	9907667
Blanco / White	600	9907668
Blanco / White	700	9907669
Blanco / White	800	9907670
Blanco / White	900	9907671
Blanco / White	1000	9907672

CUBERTERO P.S. PARA CAJÓN EUROBOX*P.S. cutlery organiser for Eurobox drawer***■ CARACTERÍSTICAS TÉCNICAS:**

Cubertero ajustado en los cuatro lados para cajones Eurobox. Para cajones de 500 mm de fondo y módulos con costados 16 mm grosor.

Acabado en P.S. gris y blanco.

■ FEATURES:

Close-fitting cutlery organiser for Eurobox drawers.

For drawers measuring 500 mm in depth and models sides 16 mm thick.

Finish: P.S. grey and white.



ACABADO Finish	MÓDULO Cabinet	CÓDIGO Code
Gris / Grey	300	9900984
Gris / Grey	350	9900985
Gris / Grey	400	9900986
Gris / Grey	450	9900987
Gris / Grey	500	9900988
Gris / Grey	600	9900989
Gris / Grey	700	9900990
Gris / Grey	800	9900991
Gris / Grey	900	9900992
Gris / Grey	1000	9900993

ACABADO Finish	MÓDULO Cabinet	CÓDIGO Code
Blanco / White	300	9907399
Blanco / White	350	9907400
Blanco / White	400	9907401
Blanco / White	450	9907402
Blanco / White	500	9907403
Blanco / White	600	9907404
Blanco / White	700	9907405
Blanco / White	800	9907406
Blanco / White	900	9907407
Blanco / White	1000	9907408

ESTERILLA ANTIDESLIZANTE PARA CAJÓN Y CACEROLERO EUROBOX*Anti-slide mat for Eurobox drawer and pan drawer***■ CARACTERÍSTICAS TÉCNICAS:**

Esterilla goma antideslizante para cajón y cacerolero Eurobox. Medidas: 480x1,2 mm. (ancho x grueso). Presentación en rollo de 20 mts.

Acabado gris y transparente.

■ FEATURES:

Rubber anti-slide mat for Eurobox drawer and pan drawer.

Measurements: 480x1.2 mm. (width x thickness). Comes in rolls of 20 metres.

Finish: grey and transparent.

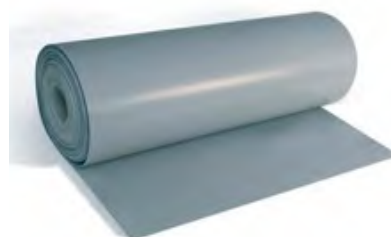

DESCRIPCIÓN Description	CÓDIGO Code
Esterilla antideslizante gris / Anti-slide mat grey	9900955
Esterilla antides. transparente / Anti-slide transparent	9907419

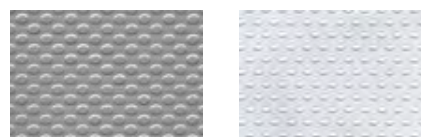
**SEPARADOR GUIAS PARA CAJÓN Y CACEROLERO EUROBOX***Guide separator for Eurobox drawer and pan drawer***■ CARACTERÍSTICAS TÉCNICAS:**

Separador de guías correderas para cajón y cacerolero Eurobox para salvar el acodamiento de la bisagras. Set de 2 piezas, grosor separador 25 mm.

■ FEATURES:

Sliding guide separator for Eurobox drawer and pan drawer to reduce hinge cranking. Set of 2 pieces, separator thickness 25 mm.

Finishes: grey and white.



DESCRIPCIÓN Description	CÓDIGO Code
Set separador guias gris / Set grey separators	9903304
Set separador guias blanco / Set white separators	9907421

ESTABILIZADOR FRONTAL PARA CAJÓN Y CACEROLERO EUROBOX

Front stabiliser for Eurobox drawer and pan drawer

■ CARACTERÍSTICAS TÉCNICAS:

Estabilizador frontal para cajón y cacerolero Eurobox. recomendado para frentes grandes a partir de 600 mm. Acabado gris.

■ FEATURES:

Front stabiliser for Eurobox drawer and pan drawer. Recommended for front pieces larger than 600 mm. Grey finish.



DESCRIPCIÓN Description	CÓDIGO Code
Estabilizador frontal Eurobox / Front stabiliser Eurobox	9900956

ACCESORIOS "U" PLASTICA PARA DESAGUE CACEROLERO EUROBOX

Accessories "U" plastic for drain Eurobox pan drawer

■ CARACTERÍSTICAS TÉCNICAS:

Accesorios para construcción de salva-sifón en cacerolero bajo fregadero.

Tira plástico 2000x69 mm altura. Los juegos de terminales delantero y trasero se tiene que pedir por separado. Acabado gris, blanco y antracita.

■ FEATURES:

Accessories for construction of salva-sifon in sink under sink. Plastic strip 2000x69 mm height. The terminal sets front and Rear must be ordered separately. Finish grey, white and anthracite.



DESCRIPCIÓN Description	CÓDIGO Code
Tira plástica gris 2000x69 mm / Plastic strip gray 2000x69 mm	9908930
Juego 4 terminales gris / Set 4 terminals gray	9908933
Tira plástica blanco 2000x69 mm / Plastic strip white 2000x69 mm	9908932
Juego 4 terminales blanco / Set 4 terminals white	9908935
Tira plástica antracita 2000x69 mm / Plastic anthracite 2000x69 mm	9908931
Juego 4 terminales antracita / Set 4 terminals anthracite	9908934

FRONTAL METALICO PARA CAJÓN INTERIOR EUROBOX

Metal front piece for Eurobox inside drawer

■ CARACTERÍSTICAS TÉCNICAS:

Frontal metálico para adaptar a cajón Eurobox y convertirlo en cajón interior.

Estabilizador para frontal incluido.

Acabado gris y blanco.

■ FEATURES:

Metal front piece to turn a Eurobox drawer into and inside drawer, Comes with front stabiliser. Finish: grey and white.



ACABADO Finish	MÓDULO Cabinet	CÓDIGO Code
Gris / Grey	600	9900976
Gris / Grey	900	9900979

ACABADO Finish	MÓDULO Cabinet	CÓDIGO Code
Blanco / White	600	9907411
Blanco / White	900	9907414

FRONTAL BARRA PARA CACEROLERO INTERIOR EUROBOX ALTURA 152 mm.

Front rod piece for Eurobox inside pan drawer 152 mm height

■ CARACTERÍSTICAS TÉCNICAS:

Frontal metálico con barra para adaptar al cacerolero Eurobox altura 152 mm y convertirlo en cacerolero interior. Estabilizador frontal incluido.

Para módulos con costados de 16 mm grosor.
Acabado gris y blanco.

■ FEATURES:

Metal front rod piece to turn a Eurobox pan drawer 152 mm in height in to an inside pan drawer. Front stabilizer included.

For models with sides measuring 16 mm tick.

Finishes grey and white.

Finish: P.S. grey and white.



ACABADO Finish	MÓDULO Cabinet	CÓDIGO Code
Gris / Grey	600	9907427
Gris / Grey	900	9907428

ACABADO Finish	MÓDULO Cabinet	CÓDIGO Code
Blanco / White	600	9907430
Blanco / White	900	9907431

FRONTAL BARRA PARA CACEROLERO INTERIOR EUROBOX ALTURA 184 mm.

Front rod piece for Eurobox inside pan drawer 184 mm height

■ CARACTERÍSTICAS TÉCNICAS:

Frontal metálico con barra para adaptar al cacerolero Eurobox altura 184 mm y convertirlo en cacerolero interior. Estabilizador frontal incluido.

Para módulos con costados de 16 mm grosor.
Acabado gris y blanco.

■ FEATURES:

Metal front rod piece to turn a Eurobox pan drawer 184 mm in height in to an inside pan drawer. Front stabilizer included.

For models with sides measuring 16 mm tick.

Finishes grey and white.



ACABADO Finish	MÓDULO Cabinet	CÓDIGO Code
Gris / Grey	600	9900980
Gris / Grey	900	9900983

ACABADO Finish	MÓDULO Cabinet	CÓDIGO Code
Blanco / White	600	9907454
Blanco / White	900	9907455

ALETA CRISTAL PARA CACEROLERO EUROBOX

Glass side panel for Eurobox pan drawer

■ CARACTERÍSTICAS TÉCNICAS:

Set 2 piezas aletas embellecedora en cristal mateado seda para lateral de cacerolero Eurobox altura 152 / 184 mm

Profundidad 500 mm.

Acabado gris y blanco.

■ FEATURES:

Set of 2 trim panels for Eurobox pan drawer side pieces with a height of 152 / 184 mm, silk matt glass.

Depths available: 500 mm.

Finishes grey and white.



DESCRIPCIÓN Description	CÓDIGO Code
Set aletas gris 500x152 mm / Set grey side panels 500x152 mm	9907423
Set aletas blanco 500x152 mm / Set white side panels 500x152 mm	9907425
Set aletas gris 500x184 mm / Set grey side panels 500x184 mm	9900966
Set aletas blanco 500x184 mm / Set white side panels 500x184 mm	9907451

KIT CAJÓN COMPLETO ATIRA ACERO PLATA ALTURA 70 mm.

Complete silver steel Atira drawer kit 70 mm height

■ CARACTERÍSTICAS TÉCNICAS:

Kit cajón completo Hettich Atira acero plata. Carga máxima 50 kg. Incluye: juego de guías correderas de extracción total y sistema de amortiguación integrada "Silent System", juego de costados laterales con doble pared, enganches frontales con regulación, soportes para trasera, fondo y trasera en melamina de 16 mm grosor.

Altura 70 mm. Fondo 470 mm.

Acabado en acero plata.

■ FEATURES:

Complete silver steel Hettich Atira drawer kit. Maximum load 50 kg. Includes: set of completely removable sliding guides and integrated "Silent System" shock absorbtion, set of side with double walls, adjustable front hooks, supports for back piece and melamine back and bottom pieces measuring 16 mm in thickness Height 70 mm. Depth 470 mm. Silver steel finish.

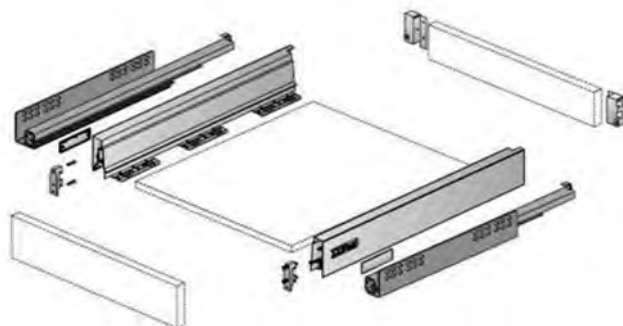

ACABADO Finish	ALTO mm Height mm	MÓDULO Cabinet	CÓDIGO Code
Acero plata / Steel	70	300	9903843
Acero plata / Steel	70	350	9903844
Acero plata / Steel	70	400	9903845
Acero plata / Steel	70	450	9903846
Acero plata / Steel	70	500	9903847
Acero plata / Steel	70	600	9903848
Acero plata / Steel	70	700	9903849
Acero plata / Steel	70	800	9903850
Acero plata / Steel	70	900	9903851
Acero plata / Steel	70	1000	9903852

KIT CAJÓN INTERIOR ARMADO ATIRA PLATA ALTURA 70 mm.

Atira inside silver steel armed drawer kit 70 mm height.

■ CARACTERÍSTICAS TÉCNICAS:

Kit cajón interior completo Atira plata. Carga máxima 50 kg. Incluye: juego de guías correderas de extracción total y sistema de amortiguación integrada "Silent System", juego de costados laterales con doble pared, frontal aluminio, enganches frontales con regulación, soportes para trasera, fondo y trasera en melamina de 16 mm grosor.

Altura 70 mm. Fondo 470 mm.

Acabado en acero plata.

■ FEATURES:

Atira inside silver steel complete drawer kit. Maximum load 50 kg. Includes: set of completely removable sliding guides and integrated "Silent System" shock absorbtion, set of side with double walls, aluminium front, adjustable front hooks, supports for back piece and melamine back and bottom pieces measuring 16 mm in thickness

Height 70 mm. Depth 470 mm. Silver steel finish.



ACABADO Finish	ALTO mm Height mm	MÓDULO Cabinet	CÓDIGO Code
Acero plata / Steel	70	300	9909626
Acero plata / Steel	70	350	9909627
Acero plata / Steel	70	400	9909628
Acero plata / Steel	70	450	9909629
Acero plata / Steel	70	500	9909630
Acero plata / Steel	70	600	9909631
Acero plata / Steel	70	700	9909632
Acero plata / Steel	70	800	9909633
Acero plata / Steel	70	900	9909634

KIT CACEROLERO COMPLETO ATIRA ACERO PLATA ALTURA 144 mm.

Complete silver steel Atira pan drawer kit 144 mm height

■ CARACTERÍSTICAS TÉCNICAS:

Kit cacerolero completo Hettich Atira acero plata. Carga máxima 50 kg. Incluye: juego de guías correderas de extracción total y sistema de amortiguación integrada "Silent System", juego de costados laterales con doble pared, enganches frontales con regulación, juego barras suplemento cacerolero, soportes para trasera, fondo y trasera en melamina 16 mm grosor. Altura 144 mm. Fondo 470 mm. Acabado en acero plata.

■ FEATURES:

Complete silver steel Hettich Atira pan drawer kit. Maximum load 50 kg. Includes: set of completely removable sliding guides and integrated "Silent System" shock absorbtion, set of sides with double walls, adjustable front hooks, supplementary set of pan drawer rods, supports for back piece, melamine back and bottom pieces measuring 16 mm in thickness. Height 70 mm. Depth 470 mm. Silver steel finish.

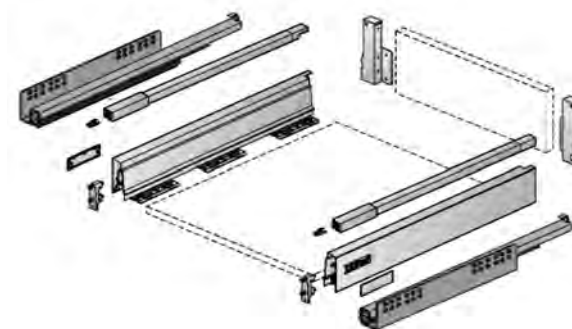

ACABADO Finish	ALTO mm Height mm	MÓDULO Cabinet	CÓDIGO Code
Acero plata / Steel	144	300	9903854
Acero plata / Steel	144	350	9903855
Acero plata / Steel	144	400	9903856
Acero plata / Steel	144	450	9903857
Acero plata / Steel	144	500	9903858
Acero plata / Steel	144	600	9903859
Acero plata / Steel	144	700	9903860
Acero plata / Steel	144	800	9903861
Acero plata / Steel	144	900	9903862
Acero plata / Steel	144	1000	9903863

KIT CACEROLERO INTERIOR ARMADO ATIRA ACERO PLATA ALTURA 144 mm.

Atira inside silver steel armed pan drawer kit 144 mm height

■ CARACTERÍSTICAS TÉCNICAS:

Kit cacerolero interior completo Atira plata. Carga máxima 50 kg. Incluye: juego de guías correderas de extracción total y sistema de amortiguación integrada "Silent System", juego de costados laterales con doble pared, frontal de aluminio, enganches frontales con regulación, juego barras suplemento cacerolero, soportes para trasera, fondo y trasera en melamina 16 mm grosor. Altura 144 mm. Fondo 470 mm. Acabado en acero plata.

■ FEATURES:

Atira inside silver steel complete drawer kit. Maximum load 50 kg. Includes: set of completely removable sliding guides and integrated "Silent System" shock absorbtion, set of sides with double walls, aluminium front piece, adjustable front hooks, supplementary set of pan drawer rods, supports for back piece, melamine back and bottom pieces measuring 16 mm in thickness. Height 144 mm. Depth 470 mm. Silver steel finish.



ACABADO Finish	ALTO mm Height mm	MÓDULO Cabinet	CÓDIGO Code
Acero plata / Steel	144	300	9909636
Acero plata / Steel	144	350	9909637
Acero plata / Steel	144	400	9909638
Acero plata / Steel	144	450	9909639
Acero plata / Steel	144	500	9909640
Acero plata / Steel	144	600	9909641
Acero plata / Steel	144	700	9909642
Acero plata / Steel	144	800	9909643
Acero plata / Steel	144	900	9909644

COMPONENTES PARA CAJONES Y CACEROLEROS ATIRA ACERO PLATA

Components for silver steel Atira drawers and pan drawers

■ CARACTERÍSTICAS TÉCNICAS:

Despiece de componentes para la construcción de cajones y caceroleros Hettich Atira en acabado acero plata.

■ FEATURES:

List of various components for the construction of drawers and pan drawers Hettich Atira steel silver finish.

DESCRIPCIÓN <i>Description</i>	CÓDIGO <i>Code</i>
Guia Quadro V6 470 mm fondo derecha / Quadro V6 470 mm right	9903172
Guia Quadro V6 470 mm fondo izquierda / Quadro V6 470 mm left	9903173
Juego guias Quadro V6 260 mm fondo / Set of V6 guides 260 mm	9903125
Juego guias Quadro V6 350 mm fondo / Set of V6 guides 350 mm	9903126
Juego guias Quadro V6 420 mm fondo / Set of V6 guides 420 mm	9903127

DESCRIPCIÓN <i>Description</i>	CÓDIGO <i>Code</i>
Atira costado plata 470x70 mm derecho / Atira silver 470x70 right	9907217
Atira costado plata 470x70 mm izquierdo / Atira silver 470x70 left	9907218
Atira juego costados plata 260x70 mm / Set Atira silver 260x70 mm	9907219
Atira juego costados plata 350x70 mm / Set Atira silver 350x70 mm	9907220
Atira juego costados plata 420x70 mm / Set Atira silver 420x70 mm	9907221

DESCRIPCIÓN <i>Description</i>	CÓDIGO <i>Code</i>
Soporte fijación del frente / Front mounting support	9902454

DESCRIPCIÓN <i>Description</i>	CÓDIGO <i>Code</i>
Soporte lateral trasera melamina cajón derecho / Back side right	9902458
Soporte lateral trasera melamina cajón izquierdo / Back side left	9902457

DESCRIPCIÓN <i>Description</i>	CÓDIGO <i>Code</i>
Barra lateral cacerolero Atira 470 mm izquierda / Side pan drawer left	9907225
Barra lateral cacerolero Atira 470 mm derecha / Side pan drawer right	9907226

DESCRIPCIÓN <i>Description</i>	CÓDIGO <i>Code</i>
Soporte fijación a frente barra cacerolero / Side pan drawer support	9903129

DESCRIPCIÓN <i>Description</i>	CÓDIGO <i>Code</i>
Soporte lateral trasera melamina cacerolero izquierdo / Support left	9902459
Soporte lateral trasera melamina cacerolero derecho / Support right	9902460

DESCRIPCIÓN <i>Description</i>	CÓDIGO <i>Code</i>
Tapa lateral para costado Atira plata / Silver side cover for Atira	9907222
Tapa lateral gris para costado Atira Diomo / Side cover for Diomo	9907148



FONDO Y TRASERA MELAMINA PARA CAJÓN ATIRA*Melamine bottom and back piece for Atira drawer***■ CARACTERÍSTICAS TÉCNICAS:**

Fondo y trasera en melamina de 16 mm grosor para cajón Atira altura 70 mm y 470 mm profundidad.

■ FEATURES:

16 mm thick melamine bottom and back piece kit for Atira drawer with 70 mm height and 470 mm depth.

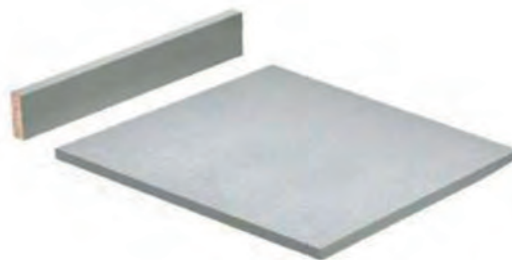

ACABADO Finish	MÓDULO Cabinet	CÓDIGO Code
Gris / Grey	300	9903697
Gris / Grey	350	9903698
Gris / Grey	400	9903699
Gris / Grey	450	9903700
Gris / Grey	500	9903701
Gris / Grey	600	9903702
Gris / Grey	700	9903703
Gris / Grey	800	9903704
Gris / Grey	900	9903705
Gris / Grey	1000	9903706

FONDO Y TRASERA MELAMINA PARA CACEROLERO ATIRA*Melamine bottom and back piece for Atira pan drawer***■ CARACTERÍSTICAS TÉCNICAS:**

Fondo y trasera en melamina de 16 mm grosor para cacerolero Atira altura 144 mm y 470 mm profundidad.

■ FEATURES:

16 mm thick melamine bottom and back piece kit for Atira pan drawer with 144 mm height and 470 mm depth.

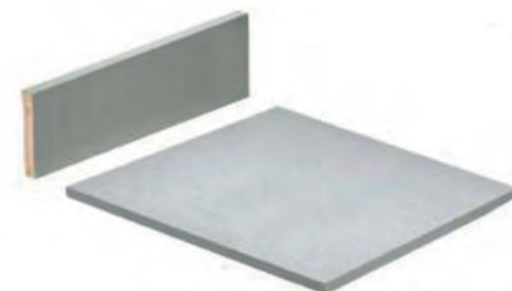

ACABADO Finish	MÓDULO Cabinet	CÓDIGO Code
Gris / Grey	300	9903708
Gris / Grey	350	9903709
Gris / Grey	400	9903710
Gris / Grey	450	9903711
Gris / Grey	500	9903712
Gris / Grey	600	9903713
Gris / Grey	700	9903714
Gris / Grey	800	9903715
Gris / Grey	900	9903716
Gris / Grey	1000	9903717

ESTABILIZADOR FRONTAL REGULABLE PARA CAJÓN Y CACEROLERO*Adjustable front stabilizer for drawer an pan drawer***■ CARACTERÍSTICAS TÉCNICAS:**

Estabilizador frontal universal metálico para cajón y cacerolero, recomendado para frentes a partir de 600 mm.

■ FEATURES:

Metallic front stabiliser for drawer and pan drawer, recommended for front pieces larger than 600 mm.



DESCRIPCIÓN Description	CÓDIGO Code
Estabilizador frontal regulable / Adjustable front stabilizer	9910646

ESTERILLA ANTIDESLIZANTE PARA CAJÓN Y CACEROLERO ATIRA

Anti-slide mat for Atira drawer and pan drawer

■ CARACTERÍSTICAS TÉCNICAS:

Esterilla goma antideslizante para cajón y cacerolero Atira.
Medidas: 470x1,2 mm. (ancho x grueso). Presentacion en rollo de 5 metros.
Acabado: gris plata.

■ FEATURES:

Rubber anti-slide mat for Atira drawer and pan drawer.
Measurements: 470x1.2 mm. (width x thickness). Comes in rolls of 5 meters.
Finish: silver grey.

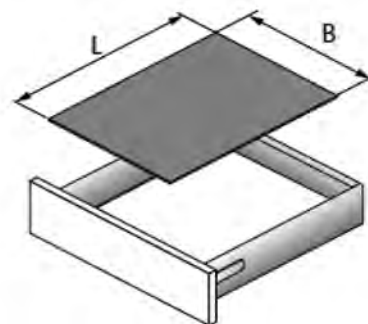

DESCRIPCIÓN Description	CÓDIGO Code
Esterilla antideslizante gris / Anti-slide mat grey	9907230

CUBERTERO ORGATRAY 590 GRIS PARA CAJÓN ATIRA

Orgatray 590 cutlery grey organiser for Atira drawer

■ CARACTERÍSTICAS TÉCNICAS:

Adaptado a anchuras de muebles estándar. La separación se puede configurar individualmente. En el juego se incluyen dos separadores por compartimento.
Para cajones con profundidad 470 mm.
Ecológico: de 100% poliestirol reciclable. Antiestático de fácil limpieza
Acabado gris plata.

■ FEATURES:

Made for standard-width drawers. Space can be configured individually.
Two separators per compartment are included in the set.
For drawers with a depth of 470 mm.
Environmentally friendly: made of 100% recyclable polyesterol.
Anti-static, easy to clean. Silver grey finish.



ACABADO Finish	MÓDULO Cabinet	CÓDIGO Code
Gris / Grey	400	9907232
Gris / Grey	450	9907233
Gris / Grey	500	9907234
Gris / Grey	600	9907235
Gris / Grey	800	9907236
Gris / Grey	900	9907237
Gris / Grey	1000	9907238

TOPSIDE PARA LATERAL CACEROLERO ATIRA

Topside for Atira pan drawer side piece

■ CARACTERÍSTICAS TÉCNICAS:

Juego 2 piezas embellecedoras de acabado para lateral cacerolero Atira.
Con adaptadores de sujeción pre montados en acabado plata.
Acabados: acero plata y cristal transparente.

■ FEATURES:

Set of 2 finishing trim pieces for Atira pan drawer side piece.
Premounted fastening adapters in silver finish.
Finishes: silver steel and transparent glass.



DESCRIPCIÓN Description	CÓDIGO Code
Juego Topside acero plata / Topside silver steel	9907227
Juego Topside acero plata cacerolero interior / Topside silver steel	9907301
Juego Topside transparente / Topside transparent	9907228

FRENTE ALUMINIO PARA CAJÓN INTERIOR ATIRA*Aluminium front piece for Atira inside drawer***■ CARACTERÍSTICAS TÉCNICAS:**

Frontal aluminio para adaptar a kit cajón Atira altura 70 mm y convertirlo en cajón interior. Con conectores de sujeción pre montados en plata. Acabado en acero plata.

■ FEATURES:

Aluminium front piece made for 70 mm high Atira drawer kit to turn it into an inside drawer. With pre-mounted fastening connectors silver. Silver steel finish.



ACABADO Finish	MÓDULO Cabinet	CÓDIGO Code
Acero plata / Silver steel	600	9907257
Acero plata / Silver steel	900	9907259

FRENTE ALUMINIO PARA CACEROLERO INTERIOR ATIRA*Aluminium front piece for Atira inside pan drawer***■ CARACTERÍSTICAS TÉCNICAS:**

Frontal aluminio para adaptar a kit cacerolero Atira altura 144 mm y convertirlo en cacerolero interior. Con conectores de sujeción pre montados en plata. Acabado en acero plata.

■ FEATURES:

Aluminium front piece made for 144 mm high Atira pan drawer kit to turn it into an inside pan drawer. With pre-mounted fastening connectors silver. Silver steel finish.



ACABADO Finish	MÓDULO Cabinet	CÓDIGO Code
Acero plata / Silver steel	600	9907288
Acero plata / Silver steel	900	9907290

KIT CAJÓN COMPLETO ARCITECH ACERO ALTURA 94 mm.

Complete steel Arcitech drawer kit 94 mm height

■ CARACTERÍSTICAS TÉCNICAS:

Kit cajón completo Hettich Arcitech acero. Carga máxima 50 kg.
 Incluye juego guías correderas de extracción total y sistema de amortiguación integrada "Silent System", juego de costados laterales con doble pared recta, enganches frontales con regulación, soportes para trasera, fondo y trasera en melamina de 16 mm grosor.
 Altura 94 mm. Profundidad 500 mm.
 Acabados en acero antracita, blanco y plata.

■ FEATURES:

Complete steel Hettich Arcitech drawer kit. Maximum load 50 kg.
 Includes set of completely removable sliding guides and integrated "Silent System" shock absorbtion, set of sides with double walls, adjustable front hooks, supports for back piece and melamine back and bottom pieces measuring 16 mm in thickness.
 Height 94 mm. Depth 500 mm.
 Finishes in anthracite, white and silver steel.



ACABADO Finish	ALTO mm Height mm	MÓDULO Cabinet	CÓDIGO Code
Antracita	94	300	9907723
Antracita	94	350	9907724
Antracita	94	400	9907725
Antracita	94	450	9907726
Antracita	94	500	9907727
Antracita	94	600	9907728
Antracita	94	700	9907729
Antracita	94	800	9907730
Antracita	94	900	9907731
Antracita	94	1000	9907732

ACABADO Finish	ALTO mm Height mm	MÓDULO Cabinet	CÓDIGO Code
Blanco / White	94	300	9909585
Blanco / White	94	350	9909586
Blanco / White	94	400	9909587
Blanco / White	94	450	9909588
Blanco / White	94	500	9909589
Blanco / White	94	600	9909590
Blanco / White	94	700	9909591
Blanco / White	94	800	9909592
Blanco / White	94	900	9909593
Blanco / White	94	1000	9909594

ACABADO Finish	ALTO mm Height mm	MÓDULO Cabinet	CÓDIGO Code
Plata / Silver	94	300	9909777
Plata / Silver	94	350	9909778
Plata / Silver	94	400	9909779
Plata / Silver	94	450	9909780
Plata / Silver	94	500	9909781
Plata / Silver	94	600	9909782
Plata / Silver	94	700	9909783
Plata / Silver	94	800	9909784
Plata / Silver	94	900	9909785
Plata / Silver	94	1000	9909786

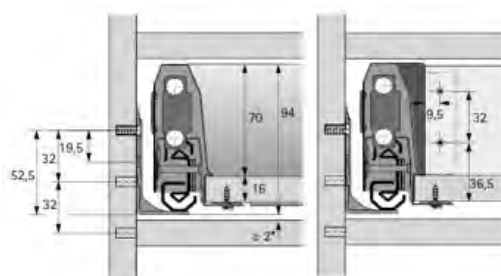
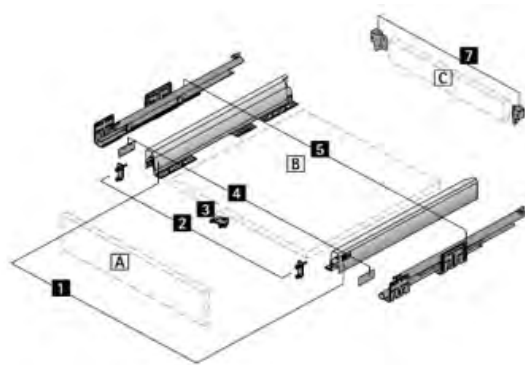

Posiciones de taladro, altura mínima montaje
 Drilling positions, minimum mounting height

KIT CACEROLERO COMPLETO ARCITECH ACERO ALTURA 186 mm.

Complete steel Arcitech pan drawer kit 186 mm height

■ CARACTERÍSTICAS TÉCNICAS:

Kit cacerolero completo Hettich Arcitech acero. Carga máxima 50 kg.

Incluye juego guías correderas de extracción total y sistema de amortiguación integrada "Silent System", juego de costados laterales con doble pared recta, enganches frontales con regulación, juego de barras suplemento cacerolero / soportes para trasera, fondo y trasera en melamina de 16 mm grosor.

Altura 186 mm. Profundidad 500 mm.

Acabados en acero antracita, blanco y plata.

■ FEATURES:

Complete steel Hettich Arcitech pan drawer kit. Maximum load 50 kg.

Includes set of completely removable sliding guides and integrated "Silent System" shock absorption, set of sides with double walls, adjustable front hooks, supplementary set of pan drawer rods, supports for back piece and melamine back and bottom pieces measuring 16 mm in thickness.

Height 186 mm. Depth 500 mm.

Finishes in anthracite, white and silver steel.



ACABADO Finish	ALTO mm Height mm	MÓDULO Cabinet	CÓDIGO Code
Antracita	186	300	9907733
Antracita	186	350	9907734
Antracita	186	400	9907735
Antracita	186	450	9907736
Antracita	186	500	9907737
Antracita	186	600	9907738
Antracita	186	700	9907739
Antracita	186	800	9907740
Antracita	186	900	9907741
Antracita	186	1000	9907742

ACABADO Finish	ALTO mm Height mm	MÓDULO Cabinet	CÓDIGO Code
Blanco / White	186	300	9909595
Blanco / White	186	350	9909596
Blanco / White	186	400	9909597
Blanco / White	186	450	9909598
Blanco / White	186	500	9909599
Blanco / White	186	600	9909600
Blanco / White	186	700	9909601
Blanco / White	186	800	9909602
Blanco / White	186	900	9909603
Blanco / White	186	1000	9909604

ACABADO Finish	ALTO mm Height mm	MÓDULO Cabinet	CÓDIGO Code
Plata / Silver	186	300	9909787
Plata / Silver	186	350	9909788
Plata / Silver	186	400	9909789
Plata / Silver	186	450	9909790
Plata / Silver	186	500	9909791
Plata / Silver	186	600	9909792
Plata / Silver	186	700	9909793
Plata / Silver	186	800	9909794
Plata / Silver	186	900	9909795
Plata / Silver	186	1000	9909796

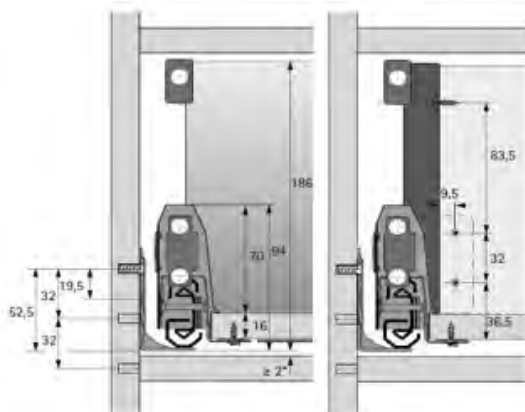
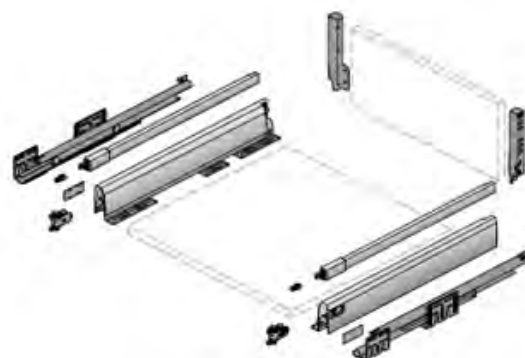

Posiciones de taladro, altura mínima montaje
Drilling positions, minimum mounting height

KIT CAJÓN INTERIOR ARMADO ARCITECH ACERO ALTURA 94 mm.

Arcitech inside steel armed drawer kit 94 mm height.

■ CARACTERÍSTICAS TÉCNICAS:

Kit cajón interior completo Arcitech acero. Carga máxima 50 kg. Incluye: juego de guías correderas de extracción total y sistema de amortiguación integrada "Silent System", juego de costados laterales con doble pared, frontal aluminio, enganches frontales con regulación, soportes para trasera, fondo y trasera en melamina de 16 mm grosor. Altura 94 mm. Fondo 500 mm. Acabados en acero antracita y blanco.

■ FEATURES:

Arcitech inside steel complete drawer kit. Maximum load 50 kg. Includes: set of completely removable sliding guides and integrated "Silent System" shock absorbtion, set of side with double walls, aluminium front, adjustable front hooks, supports for back piece and melamine back and bottom pieces measuring 16 mm in thickness Height 94 mm. Depth 500 mm. Finishes in anthracite and white.



ACABADO Finish	ALTO mm Height mm	MÓDULO Cabinet	CÓDIGO Code	ACABADO Finish	ALTO mm Height mm	MÓDULO Cabinet	CÓDIGO Code
Antracita	94	300	9909646	Blanco / White	94	300	9909656
Antracita	94	350	9909647	Blanco / White	94	350	9909657
Antracita	94	400	9909648	Blanco / White	94	400	9909658
Antracita	94	450	9909649	Blanco / White	94	450	9909659
Antracita	94	500	9909650	Blanco / White	94	500	9909660
Antracita	94	600	9909651	Blanco / White	94	600	9909661
Antracita	94	700	9909652	Blanco / White	94	700	9909662
Antracita	94	800	9909653	Blanco / White	94	800	9909663
Antracita	94	900	9909654	Blanco / White	94	900	9909664

KIT CACEROLERO INTERIOR ARMADO ARCITECH ACERO ALTURA 186 mm.

Arcitech inside steel armed pan drawer kit 186 mm height

■ CARACTERÍSTICAS TÉCNICAS:

Kit cacerolero interior completo Arcitech acero. Carga máxima 50 kg. Incluye: juego de guías correderas de extracción total y sistema de amortiguación integrada "Silent System", juego de costados laterales con doble pared, frontal de aluminio, enganches frontales con regulación, juego barras suplemento cacerolero, soportes para trasera, fondo y trasera en melamina 16 mm grosor. Altura 186 mm. Fondo 500 mm. Acabados en acero antracita y blanco.

■ FEATURES:

Arcitech inside steel complete drawer kit. Maximum load 50 kg. Includes: set of completely removable sliding guides and integrated "Silent System" shock absorbtion, set of sides with double walls, aluminium front piece, adjustable front hooks, supplementary set of pan drawer rods, supports for back piece, melamine back and bottom pieces measuring 16 mm in thickness. Height 186 mm. Depth 500 mm. Finishes in anthracite and white.



ACABADO Finish	ALTO mm Height mm	MÓDULO Cabinet	CÓDIGO Code	ACABADO Finish	ALTO mm Height mm	MÓDULO Cabinet	CÓDIGO Code
Antracita	186	300	9909666	Blanco / White	186	300	9909676
Antracita	186	350	9909667	Blanco / White	186	350	9909677
Antracita	186	400	9909668	Blanco / White	186	400	9909678
Antracita	186	450	9909669	Blanco / White	186	450	9909679
Antracita	186	500	9909670	Blanco / White	186	500	9909680
Antracita	186	600	9909671	Blanco / White	186	600	9909681
Antracita	186	700	9909672	Blanco / White	186	700	9909682
Antracita	186	800	9909673	Blanco / White	186	800	9909683
Antracita	186	900	9909674	Blanco / White	186	900	9909684

COMPONENTES PARA CAJONES Y CACEROLEROS ARCITECH ACERO

Components for steel Arcitech drawers and pan drawers

■ CARACTERÍSTICAS TÉCNICAS:

Despiece de componentes para la construcción de cajones y caceroleros Hettich Actitech en acabados acero antracita, blanco y plata.

■ FEATURES:

List of various components for the construction of drawers and pan drawers Hettich Arcitech finishes in anthracite, white and silver steel.

DESCRIPCIÓN / Description	CÓDIGO / Code
Guia Actro SS C16 500 mm fondo derecha / Actro SS guide 500 right	9907307
Guia Actro SS C16 500 mm fondo izquierda / Actro SS guide 500 left	9907308
Juego guias Actro SS C16 270 mm fondo / Set of SS guides 270 depth	9907309
Juego guias Actro SS C16 400 mm fondo / Set of SS guides 400 depth	9907310
Set guia Actro SS PUSCH L500 mm / Set of Actro pusch guides 500 mm	9909065
Set PUSH TO OPEN Arcitech SS / Set push to open Arcitech SS	9909066
Barra sincronizadora PUSCH 2000 mm / Synchronizing bar 2000 mm	9909067
Conector barra sincronizadora PUSCH / Synchronizing bar connector	9909068

DESCRIPCIÓN / Description	CÓDIGO / Code
Costado antracita 500x94 mm izquierdo / Anthracite side piece left	9907311
Costado antracita 500x94 mm derecho / Anthracite side piece right	9907312
Juego costados antracita 270x94 mm / Set anthracite 270x94 mm	9907313
Juego costados antracita 400x94 mm / Set anthracite 400x94 mm	9907314
Costado blanco 500x94 mm izquierdo / White side piece 500x94 left	9908511
Costado blanco 500x94 mm derecho / White side piece 500x94 right	9908512
Costado plata 500x94 mm izquierdo / Silver side piece 500x94 left	9908447
Costado plata 500x94 mm derecho / Silver side piece 500x94 right	9908448

DESCRIPCIÓN / Description	CÓDIGO / Code
Soporte fijación del frente Arcitech / Arcitech front mounting support	9907315

DESCRIPCIÓN / Description	CÓDIGO / Code
Soporte lateral trasera antracita cajón izquierdo / Back support left	9907316
Soporte lateral trasera antracita cajón derecho / Back support right	9907317
Soporte lateral trasera blanco cajón izquierdo / Back support left	9908515
Soporte lateral trasera blanco cajón derecho / Back support right	9908516
Soporte lateral trasera plata cajón izquierdo / Back support left	9908451
Soporte lateral trasera plata cajón derecho / Back support right	9908452

DESCRIPCIÓN / Description	CÓDIGO / Code
Barra lateral cacerolero antracita 500 mm izquierda / Side rod 500 left	9907331
Barra lateral cacerolero antracita 500 mm derecha / Side rod 500 right	9907332
Juego 2 barras cacerolero antracita 270 mm fondo / Set 2 rods 270	9907329
Juego 2 barras cacerolero antracita 400 mm fondo / Set 2 rods 400	9907330
Barra lateral cacerolero blanco 500 mm izquierda / Side rod 500 left	9908530
Barra lateral cacerolero blanco 500 mm derecha / Side rod 500 right	9908531
Barra lateral cacerolero plata 500 mm izquierda / Side rod 500 left	9908466
Barra lateral cacerolero plata 500 mm derecha / Side rod 500 right	9908467

DESCRIPCIÓN / Description	CÓDIGO / Code
Soporte lateral trasera antracita cacerolero izquierdo / Support left	9907334
Soporte lateral trasera antracita cacerolero derecho / Support right	9907335
Soporte lateral trasera blanco cacerolero izquierdo / Back support left	9908532
Soporte lateral trasera blanco cacerolero derecho / Back support right	9908533
Soporte lateral trasera plata cacerolero izquierdo / Back support left	9908468
Soporte lateral trasera plata cacerolero derecho / Back support right	9908469

DESCRIPCIÓN / Description	CÓDIGO / Code
Soporte fijación a frente barra cacerolero / Side pan drawer rod support	9907333



COMPONENTES PARA CAJONES Y CACEROLEROS ARCITECH ACERO

Components for steel Arcitech drawers and pan drawers

■ CARACTERÍSTICAS TÉCNICAS:

Despiece de componentes para la construcción de cajones y caceroleros Hettich Actitech en acabados acero antracita, blanco y plata.

■ FEATURES:

List of various components for the construction of drawers and pan drawers Hettich Arcitech finishes in anthracite. White and silver steel.

DESCRIPCIÓN Description	CÓDIGO Code
Tapa lateral costado antracita / Side cover anthracite for piece	9907318
Tapa lateral costado blanco / Side cover white for piece	9908517
Tapa lateral costado plata / Side cover silver for piece	9908453



FONDO Y TRASERA MELAMINA PARA CAJÓN ARCITECH

Melamine bottom and back piece for Arcitech drawer

■ CARACTERÍSTICAS TÉCNICAS:

Fondo y trasera en melamina de 16 mm grosor para cajón Arcitech altura 94 mm y 500 mm profundidad.

■ FEATURES:

16 mm thick melamine bottom and back piece kit for Arcitech drawer with 94 mm height and 500 mm depth.



MÓDULO Cabinet	ACABADO Finish	CÓDIGO Code	ACABADO Finish	CÓDIGO Code	ACABADO Finish	CÓDIGO Code
300	Antracita	9907673	Blanco / White	9907643	Gris / Grey	9901978
350	Antracita	9907674	Blanco / White	9907644	Gris / Grey	9901979
400	Antracita	9907675	Blanco / White	9907645	Gris / Grey	9901980
450	Antracita	9907676	Blanco / White	9907646	Gris / Grey	9901981
500	Antracita	9907677	Blanco / White	9907647	Gris / Grey	9901982
600	Antracita	9907678	Blanco / White	9907648	Gris / Grey	9901983
700	Antracita	9907679	Blanco / White	9907649	Gris / Grey	9901984
800	Antracita	9907680	Blanco / White	9907650	Gris / Grey	9901985
900	Antracita	9907681	Blanco / White	9907651	Gris / Grey	9901986
1000	Antracita	9907682	Blanco / White	9907652	Gris / Grey	9901987

FONDO Y TRASERA MELAMINA PARA CACEROLERO ARCITECH

Melamine bottom and back piece for Arcitech pan drawer

■ CARACTERÍSTICAS TÉCNICAS:

Fondo y trasera en melamina de 16 mm grosor para cacerolero Arcitech altura 186 mm y 500 mm profundidad.

■ FEATURES:

16 mm thick melamine bottom and back piece kit for Arcitech pan drawer with 186 mm height and 500 mm depth.



MÓDULO Cabinet	ACABADO Finish	CÓDIGO Code	ACABADO Finish	CÓDIGO Code	ACABADO Finish	CÓDIGO Code
300	Antracita	9907683	Blanco / White	9907663	Gris / Grey	9902000
350	Antracita	9907684	Blanco / White	9907664	Gris / Grey	9902001
400	Antracita	9907685	Blanco / White	9907665	Gris / Grey	9902002
450	Antracita	9907686	Blanco / White	9907666	Gris / Grey	9902003
500	Antracita	9907687	Blanco / White	9907667	Gris / Grey	9902004
600	Antracita	9907688	Blanco / White	9907668	Gris / Grey	9902005
700	Antracita	9907689	Blanco / White	9907669	Gris / Grey	9902006
800	Antracita	9907690	Blanco / White	9907670	Gris / Grey	9902007
900	Antracita	9907691	Blanco / White	9907671	Gris / Grey	9902008
1000	Antracita	9907692	Blanco / White	9907672	Gris / Grey	9902009

ESTERILLA ANTIDESLIZANTE PARA CAJÓN Y CACEROLERO ARCITECH

Anti-slide mat for Arcitech drawer and pan drawer

■ CARACTERÍSTICAS TÉCNICAS:

Esterilla goma antideslizante para cajón y cacerolero Arcitech.
Medidas: 500x1,2 mm. (ancho x grueso). Presentación en rollo de 5 metros.
Acabados: antracita, blanco y gris plata.

■ FEATURES:

Rubber anti-slide mat for Arcitech drawer and pan drawer.
Measurements: 500x1.2 mm. (width x thickness). Comes in rolls of 5 meters.
Finishes in anthracite, white and silver steel.

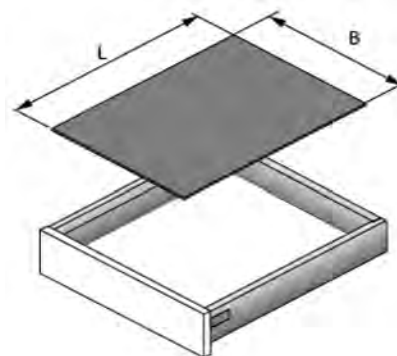

DESCRIPCIÓN / Description	CÓDIGO / Code
Esterilla antideslizante antracita / Anti-slide anthracite	9907349
Esterilla antideslizante blanco / Anti-slide white	9908924
Esterilla antideslizante plata / Anti-slide silver	9907230

CUBERTERO ORGATRAY 570 ANTRACITA PARA CAJÓN ARCITECH

Orgatray 570 cutlery anthracite organiser for Arcitech drawer

■ CARACTERÍSTICAS TÉCNICAS:

Adaptado a anchuras de muebles estándar. La separación se puede configurar individualmente. En el juego se incluyen dos separadores por compartimento.

Para cajones con profundidad 470 mm.

Ecológico: de 100% poliestireno reciclable. Antiestático de fácil limpieza

Acabados: antracita, blanco y gris plata.

■ FEATURES:

Made for standard-width drawers. Space can be configured individually.

Two separators per compartment are included in the set.

For drawers with a depth of 470 mm.

Environmentally friendly: made of 100% recyclable polystyrene.

Anti-static, easy to clean.

Finishes in anthracite, white and silver steel.



MÓDULO Cabinet	ACABADO Finish	CÓDIGO Code	ACABADO Finish	CÓDIGO Code	ACABADO Finish	CÓDIGO Code
400	Antracita	9907352	Blanco / White	9908547	Plata / Silver	9908483
450	Antracita	9907353	Blanco / White	9908548	Plata / Silver	9908484
500	Antracita	9907354	Blanco / White	9908549	Plata / Silver	9908485
600	Antracita	9907355	Blanco / White	9908550	Plata / Silver	9908486
800	Antracita	9907356	Blanco / White	9908551	Plata / Silver	9908487
900	Antracita	9907357	Blanco / White	9908552	Plata / Silver	9908488
1000	Antracita	9907358	Blanco / White	9908553	Plata / Silver	9908489

TOPSIDE PARA LATERAL CACEROLERO ARCITECH

Topside for Arcitech pan drawer side piece

■ CARACTERÍSTICAS TÉCNICAS:

Juego 2 piezas embellecedoras de acabado para lateral del cacerolero Arcitech altura 186 mm y 500 mm profundidad.

Con adaptadores de sujeción pre montados.

Acabados: cristal transparente, antracita, blanco y gris plata.

■ FEATURES:

Set of 2 finishing trim pieces for Arcitech pan drawer side piece 186 mm height and 500 mm depth. Premounted fastening adapters.

Finishes in transparent glass, anthracite, white and silver steel.



DESCRIPCIÓN / Description	CÓDIGO / Code
Juego Topside transparente / Topside transparent	9907347
Juego Topside acero antracita / Topside anthracite steel	9907346
Juego Topside acero blanco / Topside white steel	9908544
Juego Topside acero plata / Topside silver steel	9908480

FRENTE ALUMINIO PARA CAJÓN INTERIOR ARCITECH

Aluminium front piece for Arcitech inside drawer

■ CARACTERÍSTICAS TÉCNICAS:

Frontal aluminio para adaptar a kit cajón Arcitech altura 94 mm y convertirlo en cajón interior. Con conectores de sujeción pre montados.

Acabados: antracita, blanco y gris plata.

■ FEATURES:

Aluminium front piece made for 94 mm high Arcitech drawer kit to turn it into an inside drawer. With pre-mounted fastening connectors.

Finishes in anthracite, white and silver steel.



MÓDULO Cabinet	ACABADO Finish	CÓDIGO Code	ACABADO Finish	CÓDIGO Code	ACABADO Finish	CÓDIGO Code
600	Antracita	9907363	Blanco / White	9908558	Plata / Silver	9908494
900	Antracita	9907365	Blanco / White	9908560	Plata / Silver	9908496

FRENTE ALUMINIO PARA CACEROLERO INTERIOR ARCITECH

Aluminium front piece for Arcitech inside pan drawer

■ CARACTERÍSTICAS TÉCNICAS:

Frontal aluminio para adaptar a kit cacerolero Arcitech altura 186 mm y convertirlo en cacerolero interior. Con conectores de sujeción pre montados.

Acabados: antracita, blanco y gris plata.

■ FEATURES:

Aluminium front piece made for 186 mm high Arcitech pan drawer kit to turn it into an inside pan drawer. With pre-mounted fastening connectors.

Finishes in anthracite, white and silver steel.



MÓDULO Cabinet	ACABADO Finish	CÓDIGO Code	ACABADO Finish	CÓDIGO Code	ACABADO Finish	CÓDIGO Code
600	Antracita	9907383	Blanco / White	9908570	Plata / Silver	9908506
900	Antracita	9907385	Blanco / White	9908572	Plata / Silver	9908508

E.

ACCESORIOS DE INTERIOR

Interior accessories

HERRAJES Y ACCESORIOS / Kitchen Hardware



TOP FORM

LINEA CONTENEDORES, CUBO BASURA REDONDO

Containers line, round trash bin

■ CARACTERÍSTICAS TÉCNICAS:

Contenedor para basura redondo con desplazamiento con la apertura de la puerta.

Capacidad: 1 cubo 13 Lts.

Medidas: 355 alto x 277 Ø mm. Para módulo con puerta 400 mm.

Acabados: blanco y acero inox.

■ FEATURES:

Round trash bin, pulls-out when door opens.

Capacity: 1 bin 13 Lts.

Dimensions: 355 high x 277 Ø mm. For modules with door size 400 mm.

Finishes: white and stainless steel.



DESCRIPCIÓN Description	CÓDIGO Code
Cubo redondo blanco / Round white bin	9901111
Cubo redondo inox / Round stainless bin	9901112

CONTENEDOR DE RESIDUOS PARA ENCIMERA

Container of residues for worktop

■ CARACTERÍSTICAS TÉCNICAS:

Contenedor de residuos para encastre en encimera con tapa acero inox.

Capacidad: 8 lts.

Medidas: 310 alto x 225 Ø mm encastre.

Acabado: polipropileno azul.

■ FEATURES:

Waste container for recessed worktop with stainless steel lid.

Capacity: 8 lts.

Dimensions: 310 high x 225 Ø mm fit.

Finish: blue polypropylene.



DESCRIPCIÓN Description	CÓDIGO Code
Contenedor residuos encimera / Container for worktop	9908949

**LINEA CONTENEDORES, CUBO BASURA ECOLOGICO RECTANGULAR "A"**

Containers line, rectangular eco-friendly trash bin "A"

■ CARACTERÍSTICAS TÉCNICAS:

Cubo ecológico rectangular para basura, con almacenamiento para bolsas de basura.

Capacidad: 1: 14 + 1: 14 Lts.

Medidas: 398 alto x 255 ancho x 450 mm fondo. Para módulo con puerta 300 mm.

Fijación a la base del módulo. Acabado: polipropileno beige.

■ FEATURES:

Rectangular eco-friendly trash bin, with garbage bag storage.

Capacity: 1: 14 + 1: 14 Lts.

Dimensions: 398 high x 255 wide x 450 mm deep. For module with 300 mm door.

Fixed to module base. Finish: beige polypropylene.



DESCRIPCIÓN Description	CÓDIGO Code
Cubo ecológico rectangular "A" / Rectangular eco bin "A"	9901120

LINEA CONTENEDORES, CONTENEDOR DE RESIDUOS ECOFIL

Containers line, waste container Ecofil

■ CARACTERÍSTICAS TÉCNICAS:

Cubos ecológicos rectangular para basura, con sistema de extracción manual.
 Capacidad: 1: 18 + 1: 18 lts.
 Medidas: 410 alto x 310 ancho x 460 mm fondo. Para módulo con puerta 400 mm.
 Acabado: polipropileno gris.

■ FEATURES:

Rectangular ecological bin trash, with hand extraction system.
 Capacity: 1: 18 + 1: 18 lts.
 Dimensions: 410 high x 310 wide x 460 mm deep. For module with 400 mm door.
 Finish: polypropylene grey.



DESCRIPCIÓN Description	CÓDIGO Code
Ecofil ecológico 18+18 lts / Container Ecofil 18+18 lts	9907104

LINEA CONTENEDORES, CUBO BASURA ECOLOGICO RECTANGULAR "B"

Containers line, rectangular eco-friendly trash bin "B"

■ CARACTERÍSTICAS TÉCNICAS:

Cubo ecológico rectangular para basura, con sistema de fijación a puerta y apertura por desplazamiento. Capacidad: 1: 14 + 1: 14 lts.
 Medidas: 420 alto x 267 ancho x 437 mm fondo. Para módulo con puerta 400 mm.
 Acabado: acero inox.

■ FEATURES:

Rectangular eco-friendly trash bin, fixing system to displacement opening door.
 Capacity: 1: 14 + 1: 14 Lts.
 Dimensions: 420 high x 267 wide x 437 mm deep. For module with 400 mm door.
 Finish: stainless steel.



DESCRIPCIÓN Description	CÓDIGO Code
Cubo ecológico rectangular "B" / Rectangular eco bin "B"	9901118

LINEA CONTENEDORES, CUBO BASURA ECOLOGICO RECTANGULAR "L"

Containers line, rectangular eco-friendly trash bin "L"

■ CARACTERÍSTICAS TÉCNICAS:

Cubo ecológico rectangular para basura, con sistema de fijación a puerta y apertura por desplazamiento.
 Capacidad: 1: 21 + 1: 21 Lts.
 Medidas: 433 alto x 343 ancho x 475 mm fondo. Para módulo con puerta 450 mm.
 Acabado: acero inox.

■ FEATURES:

Rectangular eco-friendly trash bin, fixing system to displacement opening door.
 Capacity: 1: 21 + 1: 21 Lts.
 Dimensions: 433 high x 343 wide x 475 mm deep. For module with 450 mm door.
 Finish: stainless steel.



DESCRIPCIÓN Description	CÓDIGO Code
Cubo ecológico rectangular "L" / Rectangular eco bin "L"	9903067

LINEA CONTENEDORES, CONTENEDOR DE RESIDUOS SQUARE

Containers line, waste container Square

■ CARACTERÍSTICAS TÉCNICAS:

Contenedor ecológico rectangular para basura, con sistema de fijación a puerta y apertura extracción frontal para módulo con puerta de 600 mm.
Capacidad: 1: 24 + 1: 12 + 1: 12 + 1: 8 lbs.
Acabado: polipropileno gris.

■ FEATURES:

Rectangular eco-friendly trash bin, with fixing system door and front extraction.

For modules with door size 600 mm.

Capacity: 1: 24 + 1: 12 + 1: 12 + 1: 8 lbs.

Finish: polypropylene grey.



DESCRIPCIÓN Description	CÓDIGO Code
Cubo ecológico Square / Container Square	9905999

LINEA CONTENEDORES, CUBO BASURA ECOLOGICO RECTANGULAR "N"

Containers line, rectangular eco-friendly trash bin "N"

■ CARACTERÍSTICAS TÉCNICAS:

Cubo ecológico rectangular para basura, con sistema de fijación a puerta y apertura extracción frontal. Para módulo con puerta 450 mm.
Capacidad: 1: 35 + 1: 35 Lts.
Medidas: 570 alto x 412 > 418 ancho x 500 mm fondo.
Acabado: polipropileno gris.

■ FEATURES:

Rectangular eco-friendly trash bin, with fixing system door and front extraction.

For modules with door size 450 mm.

Capacity: 1: 35 + 1: 35 Lts.

Dimensions: 570 high x 412 > 418 wide x 500 mm deep.

Finish: polypropylene grey.



DESCRIPCIÓN Description	CÓDIGO Code
Cubo ecológico "N" / Rectangular eco-friendly "N"	9903597

LINEA CONTENEDORES, CUBO BASURA ECOLOGICO RECTANGULAR "N2"

Containers line, rectangular eco-friendly trash bin "N2"

■ CARACTERÍSTICAS TÉCNICAS:

Cubo ecológico rectangular para basura, con sistema de fijación a puerta y apertura extracción frontal. Para módulo con puerta 600 mm.
Capacidad: 1: 35 + 1: 35 + 1: 7,5 + 1: 7,5 lbs.
Medidas: 570 alto x 562 > 568 ancho x 500 mm fondo.
Acabado: polipropileno gris.

■ FEATURES:

Rectangular eco-friendly trash bin, with fixing system door and front extraction.

For modules with door size 600 mm.

Capacity: 1: 35 + 1: 35 + 1: 7,5 + 1: 7,5 lbs.

Dimensions: 570 high x 562 > 568 wide x 500 mm deep.

Finish: polypropylene grey.



DESCRIPCIÓN Description	CÓDIGO Code
Cubo ecológico "N2" / Rectangular eco-friendly "N2"	9903479

LINEA CONTENEDORES, KIT BANDEJA + CUBOS BASURA ECOLOGICOS METROPOLIS

Containers line, tray + eco-friendly trans bins Metropolis kit

■ CARACTERÍSTICAS TÉCNICAS:

Kit bandeja + cubos ecológicos para basura con tapas manuales para cacerolero
 Eurobox de anchos: 600,800 y 900 mm y frente mínimo 278 mm.
 Capacidad bandeja 600: 2: 12 lts.
 Capacidad bandeja 800: 3: 12 lts.
 Capacidad bandeja 900: 4: 12 lts.
 Acabado: polipropileno gris.

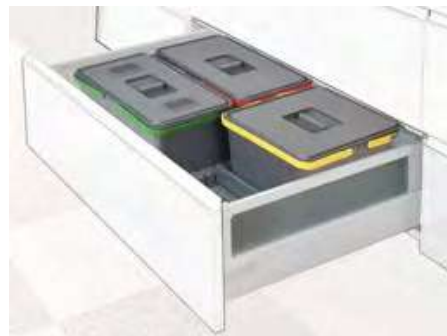

■ FEATURES:

Kit + bins tray with hand ecological trash caps for pan drawers
 Eurobox wide:
 600,800 and 900 mm, for minimum front 278 mm.
 600 Tray Capacity: 2: 12 lts.
 800 Tray Capacity: 3: 12 lts.
 900 Tray Capacity: 4: 12 lts.
 Finish: polypropylene grey.

DESCRIPCIÓN Description	CÓDIGO Code
Kit bandeja Metropolis 600 / Tray kit Metropolis 600	9907105
Kit bandeja Metropolis 800 / Tray kit Metropolis 800	9910730
Kit bandeja Metropolis 900 / Tray kit Metropolis 900	9907106



KIT BANDEJA 600



KIT BANDEJA 800

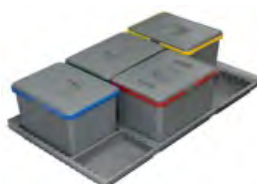

KIT BANDEJA 900

LINEA CONTENEDORES, KIT BANDEJA + CUBOS BASURA ECOLOGICOS "I"

Containers line, tray + eco-friendly trans bins "I" kit

■ CARACTERÍSTICAS TÉCNICAS:

Kit bandeja + cubos ecológicos para basura, adaptables para cualquier cacerolero de ancho 600, 800 y 900 mm. Incluye bandejas auxiliares.
 Capacidad bandeja 600: 1: 16 + 2: 7,5 lts.+ 2 bandejas.
 Capacidad bandeja 800: 2: 16 + 2: 7,5 lts.+ 3 bandejas.
 Capacidad bandeja 900: 2: 16 + 2: 7,5 lts.+ 3 bandejas.
 Altura kit 300 mm. Acabado en polipropileno gris.

■ FEATURES:

Tray + eco-friendly trash bins kit, adaptable for any pot and pan drawer widths
 600, 800 and 900 mm. Utensils included.
 600 Tray Capacity: 1: 16 + 2: 7.5 lts. + 2 trays.
 800 Tray Capacity: 2: 16 + 2: 7.5 lts. + 3 trays.
 900 Tray Capacity: 2: 16 + 2: 7.5 lts. + 3 trays.
 Kit height 300 mm. Finish: polypropylene grey.



DESCRIPCIÓN Description	CÓDIGO Code
Kit bandeja "I" 600 / Tray kit "I" 600	9901124
Kit bandeja "I" 800 / Tray kit "I" 800	9903653
Kit bandeja "I" 900 / Tray kit "I" 900	9901125

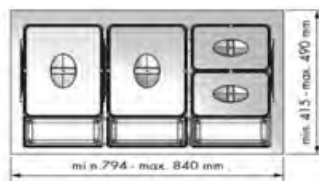
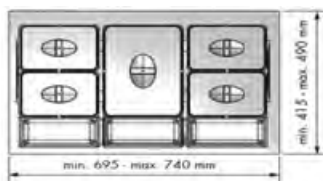
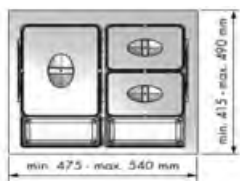

KIT ESCURREPLATOS-VASOS ACERO INOX.*Plate-glass rack kit stainless steel***■ CARACTERÍSTICAS TÉCNICAS:**

Kit escurridores en acero inox para módulos altos compuesto por escurreplatos, escurrevasos y bandeja inferior recoge aguas.
Fijación al mueble: dispositivo de presión con taladro Ø 10 mm.

■ FEATURES:

Rack kit stainless steel for high modules including plate rack, glass rack and bottom water collector tray.

Cabinet assembly: pressure device with drill Ø 10 mm.



DESCRIPCIÓN <i>Description</i>	CÓDIGO <i>Code</i>
Kit escurreplatos-vasos inox 450 / <i>Plate rack kit 450</i>	9900158
Kit escurreplatos-vasos inox 500 / <i>Plate rack kit 500</i>	9900159
Kit escurreplatos-vasos inox 600 / <i>Plate rack kit 600</i>	9900115
Kit escurreplatos-vasos inox 700 / <i>Plate rack kit 700</i>	9900116
Kit escurreplatos-vasos inox 800 / <i>Plate rack kit 800</i>	9900117
Kit escurreplatos-vasos inox 900 / <i>Plate rack kit 900</i>	9900160

KIT ESCURREPLATOS-VASOS P.S.*Plate-glass rack kit P.S.***■ CARACTERÍSTICAS TÉCNICAS:**

Kit escurridores en polietileno blanco para módulos altos compuesto por escurreplatos, escurrevasos y bandeja inferior recoge aguas.
Fijación al mueble: regletas de nylon con tirafondos.

■ FEATURES:

Rack kit white polystyrene for high modules including plate rack, glass rack and bottom water collector tray.

Cabinet assembly: nylon strips with wood screws.

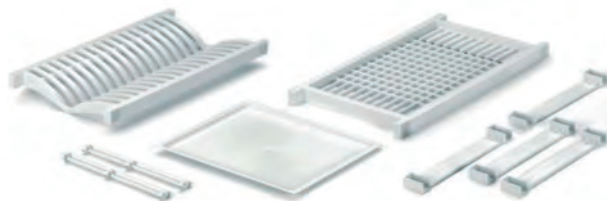

DESCRIPCIÓN <i>Description</i>	CÓDIGO <i>Code</i>
Kit escurreplatos-vasos P.S. 450 / <i>Plate rack kit P.S. 450</i>	9901141
Kit escurreplatos-vasos P.S. 500 / <i>Plate rack kit P.S. 500</i>	9901142
Kit escurreplatos-vasos P.S. 600 / <i>Plate rack kit P.S. 600</i>	9901143
Kit escurreplatos-vasos P.S. 700 / <i>Plate rack kit P.S. 700</i>	9901144
Kit escurreplatos-vasos P.S. 800 / <i>Plate rack kit P.S. 800</i>	9901145
Kit escurreplatos-vasos P.S. 900 / <i>Plate rack kit P.S. 900</i>	9901146

KIT ESCURREPLATOS-VASOS ALAMBRE PVC*Plate-glass wire rack kit PVC***■ CARACTERÍSTICAS TÉCNICAS:**

Kit escurridores blanco para módulos altos compuesto por escurreplatos y escurrevasos en alambre recubiertos en PVC.
Fijación al mueble: regletas de nylon con tirafondos.

■ FEATURES:

Rack kit white for high modules including plate rack and glass wire PVC coated.

Cabinet assembly: nylon strips with wood screws.

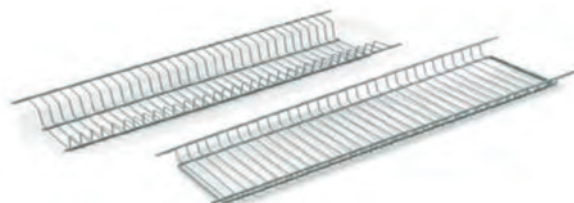

DESCRIPCIÓN <i>Description</i>	CÓDIGO <i>Code</i>
Kit escurreplatos-vasos alambre 600 / <i>Plate rack kit 600</i>	9901135
Kit escurreplatos-vasos alambre 800 / <i>Plate rack kit 800</i>	9901137
Kit escurreplatos-vasos alambre 900 / <i>Plate rack kit 900</i>	9901138

KIT BOTELLERO EXTRAIBLE QUALITY

Removable bottle rack kit Quality

■ CARACTERÍSTICAS TÉCNICAS:

Kit botellero extraíble, para módulos de 150 / 200 mm ancho.
Para montaje izquierda o derecha del mueble (indicar mano).
Medidas kit 150: 470x96x470 mm.alto, ancho y fondo.
Medidas kit 200: 470x144x470 mm.alto, ancho y fondo.
Acabado: varilla Ø 6 mm cromo.

■ FEATURES:

Removable bottle rack kit, for modules 150/200 mm wide.
Left or right cabinet assembly (specify hand).
Kit dimensions 150: 470x96x470 mm. height, width and depth.
Kit dimensions 200: 470x144x470 mm. height, width and depth.
Finish: Ø 6 mm rod chrome.



DESCRIPCIÓN Description	CÓDIGO Code
Kit botellero Quality 150 / Bottle rack kit Quality 150	9902823
Kit botellero Quality 200 / Bottle rack kit Quality 200	9902824

KIT BOTELLERO PANERO EXTRAIBLE QUALITY

Removable bottle- bread rack kit Quality

■ CARACTERÍSTICAS TÉCNICAS:

Kit botellero panero extraíble para módulos de 300/350/400 mm ancho.
Medidas kit 300: 470x214x470 mm.alto, ancho y fondo.
Medidas kit 350: 470x264x470 mm.alto, ancho y fondo.
Medidas kit 400: 470x314x470 mm.alto, ancho y fondo.
Acabado: varilla Ø 6 mm cromo.

■ FEATURES:

Removable bottle-bread rack kit, for modules 300/350/400 mm wide.
Kit dimensions 300: 470x214x470 mm. height, width and depth.
Kit dimensions 350: 470x264x470 mm. height, width and depth.
Kit dimensions 400: 470x314x470 mm. height, width and depth.
Finish: Ø 6 mm rod chrome.



DESCRIPCIÓN Description	CÓDIGO Code
Kit botellero-panero Quality 300 / Bottle-bread kit 300	9902825

KIT CARRUSEL GIRATORIO 360° QUALITY

360° rotating carousel kit Quality

■ CARACTERÍSTICAS TÉCNICAS:

Kit herraje giratorio 360° para módulos bajos de rincón angular.
Compuesto por: estructura giratoria, seis cestos con correderas extraíbles y seis cestos para colgar.
Acabado: varilla Ø 6 mm cromo.

■ FEATURES:

360° rotating metalware kit, for angled corner modules.
Kit includes: rotating structure, six racks with removable guideways and six hanging racks.
Finish: Ø 6 mm rod chrome.



DESCRIPCIÓN Description	CÓDIGO Code
Carrusel giratorio QUALITY 360° / 360° rotating carousel	9900172

KIT RINCON EXTRAIBLE FRONTAL ARTICULADO QUALITY*Removable front-angled corner kit Quality***■ CARACTERÍSTICAS TÉCNICAS:**

Conjunto extraíble frontal articulado para módulo rincón ciego.

Terminaciones izquierda y derecha, para módulos de ancho mínimo 900 mm y puerta de 450-500 mm.

Compuesto por: conjunto extraíble articulado de dos bastidores unidos con extracción automática del bastidor interior en un solo movimiento con extracción total y cuatro cestos para organización interna.

Acabado: varilla Ø 6 mm cromo.

■ FEATURES:

Removable front-angled set for blind corner module.

Left and right ends, for modules of minimum 900 mm wide and 450-500 mm door size.

Set includes: removable angled set of two connected frames, interior frames is auto-extensible in just one movement, full extension and racks for internal organising.

Finish: Ø 6 mm rod chrome.

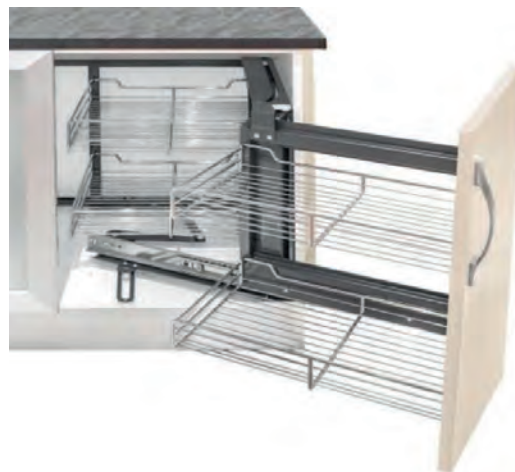

DESCRIPCIÓN <i>Description</i>	CÓDIGO <i>Code</i>
Rincón Quality extraíble derecho / <i>Removable corner right</i>	9900168
Rincón Quality extraíble izquierdo / <i>Removable corner left</i>	9900169

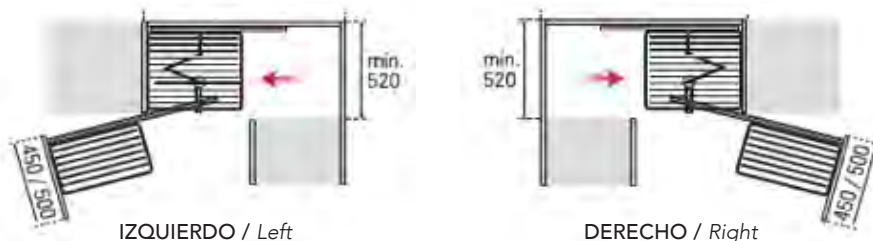
**KIT RINCON EXTRAIBLE TOTAL REVERSIBLE QUALITY***Removable total angled corner kit Quality***■ CARACTERÍSTICAS TÉCNICAS:**

Conjunto extraíble articulado para módulo de rincón ciego, izquierdo o derecho, para módulos de 800-900 ancho mínimo y puerta abisagrada 400-450 mm.

Compuesto por: conjunto extraíble articulado de dos bastidores unidos con extracción manual de ambos, extracción total con cierre amortiguado y cuatro cestos para organización interna.

Acabado: varilla Ø 6 mm cromo.

■ FEATURES:

Removable front-angled set for blind corner module, with left and right ends.

For modules of minimum 800-900 mm wide and 400-450 mm hinged door.

Set includes: removable angled set of two connected frames, both frames manually extensible, full extension with, soft closing and four racks for internal organising.

Finish: Ø 6 mm rod chrome.

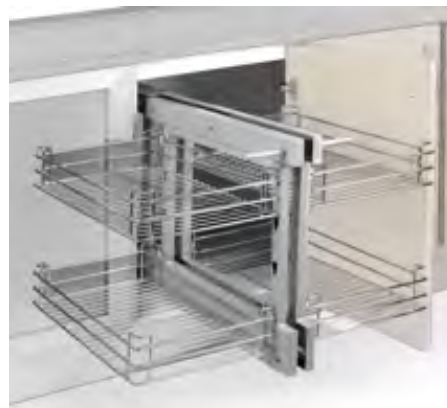

DESCRIPCIÓN <i>Description</i>	CÓDIGO <i>Code</i>
Rincón Quality extraíble total / <i>Removable total corner</i>	9907109

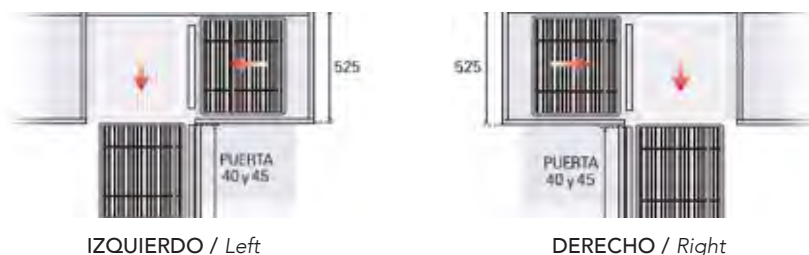

KIT BOTELLERO ESPECIERO PANERO VERSÁTIL DELUXE

Bottle-spice-bread rack kit Deluxe

■ CARACTERÍSTICAS TÉCNICAS:

Kit botellero-especiero-panero versátil para módulos de 150/200/250/300/350 y 400 mm de ancho y alturas de mueble 700 y 800 mm. Guía superpuestas con sistema cierre amortiguado Soft closing. Accesorios: bolsa panero de tela y rejilla de cierre incluidos. Carga máxima 30 kg. Acabado: pletina oval en cromo o grafito.

■ FEATURES:

Bottle-spice-bread rack kit versatile for modules of 150/200/250/300/350 and 400 mm wide and heights of furniture 700 and 800 mm. Overlapping guide with mortised Soft Closing system. Accessories: cloth bread bag and closing grid included. Maximum load 30 kg. Finish: oval plate in chrome or graphite.



DESCRIPCION ALTURA 700 mm Description height 700 mm	CÓDIGO Code
Botellero versátil cromo 150 mm / Versatiles rack chrome 150 mm	9909332
Botellero versátil cromo 200 mm / Versatile rack chrome 200 mm	9909334
Botellero versátil cromo 250 mm / Versatile rack chrome 250 mm	9909336
Botellero versátil cromo 300 mm / Versatile rack chrome 300 mm	9909338
Botellero versátil cromo 350 mm / Versatile rack chrome 350 mm	9909340
Botellero versátil cromo 400 mm / Versatile rack chrome 400 mm	9909342
Botellero versátil grafito 150 mm / Versatile rack graphite 150 mm	9909333
Botellero versátil grafito 200 mm / Versatile rack graphite 200 mm	9909335
Botellero versátil grafito 250 mm / Versatile rack graphite 250 mm	9909337
Botellero versátil grafito 300 mm / Versatile rack graphite 300 mm	9909339
Botellero versátil grafito 350 mm / Versatile rack graphite 350 mm	9909341
Botellero versátil grafito 400 mm / Versatile rack graphite 400 mm	9909343



Altura 700 mm
Height 700 mm

DESCRIPCION ALTURA 800 mm Description height 800 mm	CÓDIGO Code
Botellero versátil cromo 150 mm / Versatiles rack chrome 150 mm	9909344
Botellero versátil cromo 200 mm / Versatile rack chrome 200 mm	9909346
Botellero versátil cromo 250 mm / Versatile rack chrome 250 mm	9909348
Botellero versátil cromo 300 mm / Versatile rack chrome 300 mm	9909350
Botellero versátil cromo 350 mm / Versatile rack chrome 350 mm	9909352
Botellero versátil cromo 400 mm / Versatile rack chrome 400 mm	9909354
Botellero versátil grafito 150 mm / Versatile rack graphite 150 mm	9909345
Botellero versátil grafito 200 mm / Versatile rack graphite 200 mm	9909347
Botellero versátil grafito 250 mm / Versatile rack graphite 250 mm	9909349
Botellero versátil grafito 300 mm / Versatile rack graphite 300 mm	9909351
Botellero versátil grafito 350 mm / Versatile rack graphite 350 mm	9909353
Botellero versátil grafito 400 mm / Versatile rack graphite 400 mm	9909355



Altura 800 mm
Height 800 mm



KIT RINCON BANDEJAS GEMELAS DELUXE

Corner kit trays twins Deluxe

■ CARACTERÍSTICAS TÉCNICAS:

Conjunto de bandejas deslizantes de extracción independientes para módulos de rincón ciego con puerta abisagrada, terminaciones izquierda y derecha.

Con sistema de cierre asistido Soft Closing. Peso máximo por bandeja 15 kg.

Para módulos 900-1000 mm y puerta de 450 / 500 mm ancho.

Barra extensible para altura de módulos 700 y 800 mm.

Acabados: cromo-blanco y grafito.

■ FEATURES:

Set of independent extraction sliding trays for modules blind corner with hinged door, endings left and right.

With Soft Closing assisted closing system. Maximum weight per tray 15 kg.

For 900-1000 mm modules and 450/500 mm wide door.

Extendable bar for height of modules 700 and 800 mm.

Finishes: chrome-white and graphite.



DESCRIPCIÓN / Description	CÓDIGO / Code
Bandejas Deluxe cromo-blanco derecha / Chrome-white right Deluxe	9900170
Bandejas Deluxe cromo-blanco izquierda / Chrome-white left Deluxe	9900171
Bandejas Deluxe grafito derecha / Graphite right Deluxe	9909330
Bandejas Deluxe grafito izquierda / Graphite left Deluxe	9909331

IZQUIERDO / Left

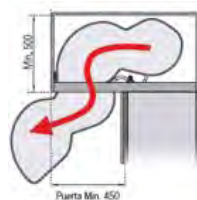

DERECHO / Right

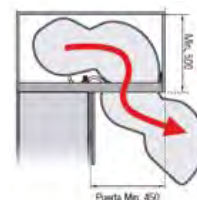
**KIT RINCON EXTRAIBLE TOTAL REVERSIBLE DELUXE**

Removable total angled corner kit Deluxe

■ CARACTERÍSTICAS TÉCNICAS:

Conjunto extraíble articulado reversible para módulo de rincón ciego, izquierdo o derecho, para módulos de 900-1000 ancho y puerta abisagrada de 400/450 mm.

Peso máximo por bandeja 8 kg.

Compuesto por: conjunto extraíble articulado de dos bastidores unidos con extracción manual de ambos, extracción total con cierre amortiguado y cuatro cestos para organización interna.

Acabados: cromo-blanco y grafito.

■ FEATURES:

Reversible articulated removable assembly for blind corner, left or right, for modules of 900-1000 width and hinged door of 400/450 mm. Maximum weight per tray 8 kg.

Composed of: articulated removable assembly of two frames united with manual extraction of both, total extraction with cushioned closure and four baskets for internal organization.

Finishes: chrome-white and graphite.

Finish: Ø 6 mm rod chrome.



DESCRIPCIÓN / Description	CÓDIGO / Code
Rincón extraíble Deluxe cromo-blanco / Chrome-white Deluxe	9909356
Rincón extraíble Deluxe grafito / Graphite Deluxe	9909357

IZQUIERDO / Left

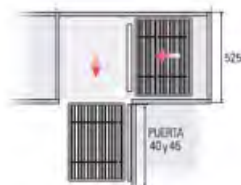

DERECHO / Right



KIT COLUMNA EXTRAIBLE DELUXE

Removable column kit Deluxe

■ CARACTERÍSTICAS TÉCNICAS:

Kit columna extraíble para módulos de 300-350-400-450-500 y 600 mm ancho. Con dos versiones de altura: 1250-1570 y 1850-2170 mm.

Kit compuesto por: bastidor columna con fijaciones al frontal, cestos interiores y guías correderas de extracción total y cierre asistido Soft Closing para fijación en la parte inferior y superior del módulo.

Peso máximo por bandeja 7,5 kg.

Acabados: cromo-blanco y grafito.

■ FEATURES:

Removable column kit for 300-350-400-450-500 and 600 mm wide modules.

With two versions of height: 1250-1570 and 1850-2170 mm.

Kit composed of: column frame with fixings to the front, inner baskets and sliding guides of total extraction and assisted closing Soft Closing for fixing in the lower and upper part of the module.

Maximum weight per tray 7.5 kg.

Finishes: chrome-white and graphite.



ALTURA Height	ACABADO Finish	MÓDULO Cabinet	CESTOS Basquets	CÓDIGO Code
1250 - 1570	Cromo-blanco	300	4	9909358
1250 - 1570	Cromo-blanco	350	4	9909360
1250 - 1570	Cromo-blanco	400	4	9909362
1250 - 1570	Cromo-blanco	450	4	9909364
1250 - 1570	Cromo-blanco	500	4	9909366
1250 - 1570	Cromo-blanco	600	4	9909368
1250 - 1570	Grafito	300	4	9909359
1250 - 1570	Grafito	350	4	9909361
1250 - 1570	Grafito	400	4	9909363
1250 - 1570	Grafito	450	4	9909365
1250 - 1570	Grafito	500	4	9909367
1250 - 1570	Grafito	600	4	9909369

ALTURA Height	ACABADO Finish	MÓDULO Cabinet	CESTOS Basquets	CÓDIGO Code
1850 - 2170	Cromo-blanco	300	6	9909404
1850 - 2170	Cromo-blanco	350	6	9909406
1850 - 2170	Cromo-blanco	400	6	9909408
1850 - 2170	Cromo-blanco	450	6	9909410
1850 - 2170	Cromo-blanco	500	6	9909412
1850 - 2170	Cromo-blanco	600	6	9909414
1850 - 2170	Grafito	300	6	9909405
1850 - 2170	Grafito	350	6	9909407
1850 - 2170	Grafito	400	6	9909409
1850 - 2170	Grafito	450	6	9909411
1850 - 2170	Grafito	500	6	9909413
1850 - 2170	Grafito	600	6	9909415



Cromo-blanco / Chrome-white



Grafito / Graphite

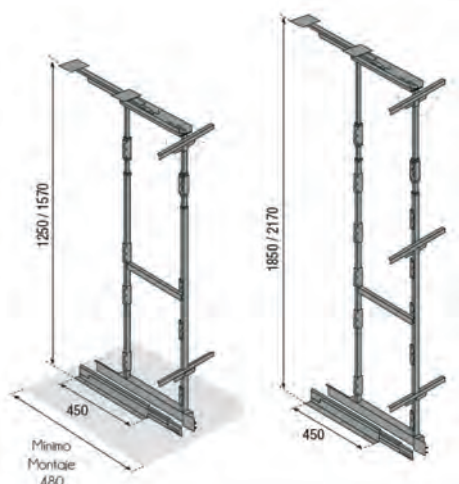

KIT BOTELLERO EXTRAIBLE PLUS 150/200

Removable bottle rack kit Plus 150/200

■ CARACTERÍSTICAS TÉCNICAS:

Kit botellero extraíble, para módulos de 150 / 200 mm ancho, montaje izquierda o derecha del mueble (indicar mano). Carga máxima 15 kg.
Medidas kit 150: 500x108x487 mm.alto, ancho y fondo. Extracción total.
Medidas kit 200: 500x132x487 mm.alto, ancho y fondo. Extracción total.
Acabado: acero cromo.

■ FEATURES:

Removable bottle rack kit, for modules 150/200 mm wide, left or right cabinet assembly (specify hand). Maximum load 15 kg. Finish chrome steel.
Kit dimensions 150: 500x108x487 mm. height, width and depth. Full extension.
Kit dimensions 200: 500x132x487 mm. height, width and depth. Full extension.



DESCRIPCIÓN / Description	CÓDIGO / Code
Kit botellero Plus 150 derecho / Bottle rack kit Plus 150 right	9901174
Kit botellero Plus 150 izquierdo / Bottle rack kit Plus 150 left	9901175
Kit botellero Plus 200 derecho / Bottle rack kit Plus 200 right	9901176
Kit botellero Plus 200 izquierdo / Bottle rack kit Plus 200 left	9901177
Juego bases botellero 150 / Set bottom unist 150	9907587

KIT BOTELLERO EXTRAIBLE PLUS 150 PARA ALTURA 800

Removable bottle rack kit Plus 150 for 800 height

■ CARACTERÍSTICAS TÉCNICAS:

Kit botellero extraíble, para modulo de 150 mm ancho, montaje izquierda o derecha del mueble (indicar mano). Carga máxima 15 kg.
Para módulos bajos estándar con altura 800 mm.
Medidas kit 150: 675x108x487 mm.alto, ancho y fondo. Extracción total.
Acabado: acero cromo.

■ FEATURES:

Removable bottle rack kit for modules 150 mm wide, left or right cabinet assembly (specify hand). Maximum load 15 kg.
For standard base modules with 800 mm height.
Kit dimensions 150: 675x108x487 mm. height, width and depth. Full extension.
Finish: chrome steel.



DESCRIPCIÓN / Description	CÓDIGO / Code
Kit botellero Plus 150 derecho (800) / Bottle rack kit Plus right (800)	9905417
Kit botellero Plus 150 Izquierdo (800) / Bottle rack kit Plus left (800)	9905418
Juego bases botellero gris 150 / Set bottom grey unist 150	9908599

KIT BOTELLERO EXTRAIBLE PLUS 300/400

Removable bottle rack kit Plus 300/400

■ CARACTERÍSTICAS TÉCNICAS:

Kit botellero extraíble para módulos de 300/400 mm ancho. Carga máxima 30 kg.
Medidas kit 300: 516x268x487 mm.alto, ancho y fondo. Extracción total.
Medidas kit 400: 516x368x487 mm.alto, ancho y fondo. Extracción total.
Acabado: acero cromo.

■ FEATURES:

Removable bottle rack kit for modules 300/400 mm wide. Maximum load 30 kg.
Kit dimensions 300: 516x268x487 mm. height, width and depth. Full extension.
Kit dimensions 400: 516x368x487 mm. height, width and depth. Full extension.
Finish: chrome steel.



DESCRIPCIÓN / Description	CÓDIGO / Code
Kit botellero Plus 300 / Bottle rack kit Plus 300	9901178
Kit botellero Plus 400 / Bottle rack kit Plus 400	9901179
Juego bases botellero 300 / Set bottom unist 300	9907588
Juego bases botellero 400 / Set bottom unist 400	9907589

KIT BOTELLERO PANERO EXTRAIBLE PLUS

Removable bottle-bread rack kit Plus

■ CARACTERÍSTICAS TÉCNICAS:

Kit botellero panero extraíble para módulos de 300/400 mm.
Carga máxima 30 kg.
Medidas kit 300: 516x268x487 mm.alto, ancho y fondo. Extracción total.
Medidas kit 400: 516x368x487 mm.alto, ancho y fondo. Extracción total.
Acabado: acero cromo.

■ FEATURES:

Removable bottle-bread rack kit for modules 300/400 mm wide.
Maximum load 30 kg.
Kit dimensions 300: 516x268x487 mm. height, width and depth. Full extension.
Kit dimensions 400: 516x368x487 mm. height, width and depth. Full extension.
Finish: chrome steel.



DESCRIPCIÓN / Description	CÓDIGO / Code
Kit botellero panero Plus 300 / Bottle-bread rack Plus 300	9901180
Kit botellero panero Plus 400 / Bottle-bread rack Plus 400	9901181
Juego bases botellero-panero 300 / Set bottom unist 300	9907590
Juego bases botellero-panero 400 / Set bottom unist 400	9907591

KIT DESPENSAERO EXTRAIBLE PLUS

Removable pantry rack kit Plus

■ CARACTERÍSTICAS TÉCNICAS:

Kit despensero extraíble para módulos de 300/400 mm ancho.
Carga máxima 30 kg.
Medidas kit 300: 516x268x487 mm.alto, ancho y fondo. Extracción total.
Medidas kit 400: 516x368x487 mm.alto, ancho y fondo. Extracción total.
Acabado: acero cromo.

■ FEATURES:

Removable pantry rack kit for modules 300/400 mm wide. Maximum load 30 kg.
Kit dimensions 300: 516x268x487 mm. height, width and depth. Full extension.
Kit dimensions 400: 516x368x487 mm. height, width and depth. Full extension.
Finish: chrome steel.



DESCRIPCIÓN / Description	CÓDIGO / Code
Kit despensero Plus 300 / Pantry rack kit Plus 300	9901182
Kit despensero Plus 400 / Pantry rack kit Plus 400	9901183
Juego bases despensero 300 / Set bottom unist 300	9907592
Juego bases despensero 400 / Set bottom unist 400	9907593

KIT CESTILLO MULTIUSOS EXTRAIBLE PLUS

Removable multipurpose basket rack kit Plus

■ CARACTERÍSTICAS TÉCNICAS:

Kit cestillo multiusos extraíble manual para modulo con puerta abisagrada.
Altura cestillo 198 mm, extracción total. Carga máxima 45 kg.
Acabado: acero cromo.

■ FEATURES:

Manually removable multipurpose basket kit for hinged door modules.
Basket height 198 mm, full extension. Maximum load 45 kg.
Finish: chrome steel.



DESCRIPCIÓN / Description	CÓDIGO / Code
Kit cestillo multiusos Plus 300 / Multipurpose basket 300	9902817
Kit cestillo multiusos Plus 350 / Multipurpose basket 350	9902818
Kit cestillo multiusos Plus 400 / Multipurpose basket 400	9902819
Kit cestillo multiusos Plus 450 / Multipurpose basket 450	9902820
Kit cestillo multiusos Plus 500 / Multipurpose basket 500	9902821
Kit cestillo multiusos Plus 600 / Multipurpose basket 600	9902822

KIT CESTO FRONTAL BAJO FREGADERO PLUS*Under-sink front rack kit Plus***■ CARACTERÍSTICAS TÉCNICAS:**

Kit cesto frontal para montaje bajo fregadero, con guías correderas Quadro de bolas de acero, extracción total y cierre amortiguado Silent System.

Carga dinámica 30 kg.

Kit compuesto por: cesto frontal, juego bandejas accesorios de limpieza y varios soportes separadores.

Acabado: acero inox. Bandejas y separadores: polipropileno gris.

■ FEATURES:

Under-sink front rack kit, with guideways steel ball frame, full extension and Silent System for soft closing. Dynamic load 30 kg.

Kit includes: front basket, trays game accessories cleaning and several standoffs.

Front basket finish: silver steel. Tray and separators finish: grey polypropylene.



DESCRIPCIÓN / Description	CÓDIGO / Code
Kit Cesto frontal 600 Plus / Front Rack kit 600 Plus	9901095
Kit Cesto frontal 800 Plus / Front Rack kit 800 Plus	9901096
Kit Cesto frontal 900 Plus / Front Rack kit 900 Plus	9901097

KIT TOLVA ROPA EXTRAIBLE PLUS*Removable laundry chute rack kit Plus***■ CARACTERÍSTICAS TÉCNICAS:**

Kit tolva ropa extraíble para módulos de 400/450/600 mm.

Carga máxima 30 kg.

Medidas kit 400: 475x368x487 mm.alto, ancho y fondo. Extracción total.

Medidas kit 450: 475x418x487 mm.alto, ancho y fondo. Extracción total.

Medidas kit 600: 475x568x487 mm.alto, ancho y fondo. Extracción total.

Acabado: acero cromo.

■ FEATURES:

Removable laundry chute kit for modules 400/450/600 mm.

Maximum load 30 kg.

Kit dimensions 400: 475x368x487 mm. height, width and depth. Full extension.

Kit dimensions 450: 475x418x487 mm. height, width and depth. Full extension.

Kit dimensions 600: 475x568x487 mm. height, width and depth. Full extension.

Finish: chrome steel.



DESCRIPCIÓN / Description	CÓDIGO / Code
Kit tolva ropa Plus 400 / Laundry chute kit Plus 400	9901185
Kit tolva ropa Plus 450 / Laundry chute kit Plus 450	9901186
Kit tolva ropa Plus 600 / Laundry chute kit Plus 600	9901187

KIT ACCESORIOS LIMPIEZA EXTRAIBLE PLUS*Removable cleaning accessory rack kit Plus***■ CARACTERÍSTICAS TÉCNICAS:**

Kit accesorios limpieza extraíble manual para modulo con puerta abisagrada y ancho mínimo 300 mm. Carga máxima 30 kg.

Medidas kit 300: 435x250x435 mm.alto, ancho y fondo. Extracción total.

Acabado: acero cromo.

■ FEATURES:

Manually removable cleaning accessory rack kit for hinged door modules and minimum width 300 mm. Maximum load 30 kg.

Kit dimensions 300: 435x250x435 mm. height, width and depth. Full extension.

Finish: chrome steel.



DESCRIPCIÓN / Description	CÓDIGO / Code
Kit accesorios limpieza Plus 300 / Cleaning rack kit Plus 300	9901188

HERRAJE MESA EXTRAIBLE-B PLUS

Removable table metalware-B Plus

■ CARACTERÍSTICAS TÉCNICAS:

Herraje de mesa extraíble para frente de cajón móvil adaptable a anchos estándar.

Medidas: fondo 540 mm y largo extracción 820 mm.

Carga máxima 55 kg.

Acabado: Acero cincado.

Nota: el herraje no incluye la base de laminado o melamina.

■ FEATURES:

Removable table metalware for front drawer mobile adaptable to standard widths.

Dimensions: 540 mm deep and 820 mm long extraction.

Maximum load 55 kg.

Finish: Zinc covered steel.

Note: no hardware includes base or melamine laminate.



DESCRIPCIÓN / Description	CÓDIGO / Code
Herraje mesa B Plus / Table metalware B Plus	9901308

MESA DE PLANCHADO EXTRAIBLE PLUS

Removable ironing table Plus

■ CARACTERÍSTICAS TÉCNICAS:

Conjunto para mesa extraíble de planchado, extensible para módulos de 400/450 y 600 mm ancho. Carga máxima 40 kg.

Medidas: fondo 500 mm y largo extracción 950 mm.

Acabado: acero blanco.

■ FEATURES:

Removable ironing table set, extensible for modules 400/450 and 600 mm wide.

Maximum load 40 kg.

Dimensions: 500 mm deep and 950 mm extension length.

Finish: White steel.



DESCRIPCIÓN / Description	CÓDIGO / Code
Mesa planchado extraíble Plus / Removable ironing table	9901303

KIT BANDEJAS SEMICIRCULARES 180° PLUS 700-800 ALTURA

180° semi-round tray kit Plus 700 and 800 height

■ CARACTERÍSTICAS TÉCNICAS:

Conjunto de bandejas semicirculares unidas mediante eje regulable de 630 > 730 mm

Conjunto de bandejas semicirculares unidas mediante eje regulable de 730 > 780 mm

para módulos de rincón ciego altura 700/800 mm, con ancho mínimo 900 y puerta

abisagrada de 450-500 mm. Carga dinámica: 20 kg por bandeja.

Acabado: acero cromo.

■ FEATURES:

Semi-round tray kit joined by axis 630 > 730 mm for blind corner modules 700 mm

Semi-round tray kit joined by axis 730 > 780 mm for blind corner modules 800 mm

height of minimum 900 mm wide and 450-500 mm hinged door.

Dinamic load: 20 kg per tray.

Finish: chrome steel.



DESCRIPCIÓN / Description	CÓDIGO / Code
Kit Bandejas Plus puerta 450 mm (700) / Tray kit Plus 450 door (700)	9901231
Kit Bandejas Plus puerta 450 mm (800) / Tray kit Plus 450 door (800)	9905427
Kit Bandejas Plus puerta 500 mm (700) / Tray kit Plus 500 door (700)	9901232
Kit Bandejas Plus puerta 500 mm (800) / Tray kit Plus 500 door (800)	9905428

KIT BANDEJAS GIRATORIAS 270° PLUS 700-800 ALTURA

270° rotating tray kit Plus 700 and 800 height

■ CARACTERÍSTICAS TÉCNICAS:

Conjunto de bandejas circulares unidas mediante un eje regulable de 630 > 730 mm para modulo bajo rincón angular altura 700 mm y diámetros de: Ø 700 y Ø 820 mm.

Conjunto de bandejas circulares unidas mediante un eje regulable de 730 > 780 mm para modulo bajo rincón angular altura 800 mm y diámetros de: Ø 700 y Ø 820 mm.

Carga dinámica: 20 kg por bandeja.

Acabado: acero cromo.

■ FEATURES:

Round tray kit joined by central axis 630 > 730 mm for angled corner modules height 700 mm with diameters: Ø 700 and Ø 820 mm.

Round tray kit joined by central axis 730 > 780 mm for angled corner modules height 800 mm with diameters: Ø 700 and Ø 820 mm.

Dynamic load: 20 kg per tray.

Finish: chrome steel.



DESCRIPCIÓN / Description	CÓDIGO / Code
Kit Bandejas Plus 270° Ø 700 (700) / 270° Tray kit Plus Ø 700 (700)	9901233
Kit Bandejas Plus 270° Ø 700 (800) / 270° Tray kit Plus Ø 700 (800)	9905429
Kit Bandejas Plus 270° Ø 820 (700) / 270° Tray kit Plus Ø 820 (700)	9901234
Kit Bandejas Plus 270° Ø 820 (800) / 270° Tray kit Plus Ø 820 (800)	9905430

RINCON BASTIDOR EXTRAIBLE FRONTAL ARTICULADO PLUS

Removable front-angled corner frame Plus

■ CARACTERÍSTICAS TÉCNICAS:

Conjunto extraíble frontal articulado para modulo rincón ciego con terminación izquierda o derecha, para módulos de ancho mínimo 900 mm y puerta de 400-450 mm.

Compuesto por: conjunto extraíble articulado de dos bastidores unidos con extracción automática del bastidor interior en un solo movimiento, con sistema de cierre amortiguado y cuatro cestos para organización interna.

Carga dinámica: 9,5 kg cesta interna y 8 kg cesta frontal.

Acabado: acero cromo.

■ FEATURES:

Removable front angled set for blind corner module left and right ends, for modules

of minimum 900 mm wide and 400-450 door size.

Set includes: removable angled set of two connected frames, interior frames is auto-extensible in just one movement, soft closing and four racks for organising.

Dynamic load: 9,5 kg interior rack and 8 kg front rack.

Finish: chrome steel.



DESCRIPCIÓN / Description	CÓDIGO / Code
Rincón Plus extraíble derecho / Removable Plus corner right	9905317
Rincón Plus extraíble izquierdo / Removable Plus corner left	9905318

DERECHO / Right

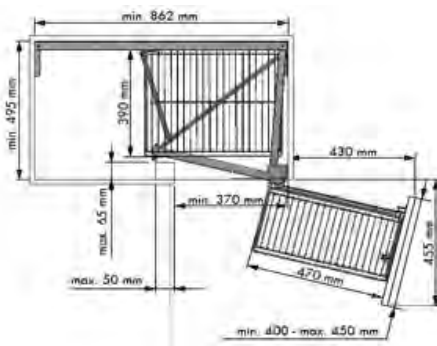

KIT COLUMNA EXTRAIBLE PLUS

Removable column kit Plus

■ CARACTERÍSTICAS TÉCNICAS:

Kit columna extraíble para módulos de 300/400 y 450 mm ancho.

Altura: 1900-2300 mm.

Kit compuesto por: bastidor columna con fijaciones al frontal, cestos interiores y guías correderas de extracción total y cierre amortiguado, para fijación en la parte inferior y superior del módulo. Con sistema de regulación 3D para ajuste perfecto.

Carga máxima 120 kg.

Acabado: acero cromo.

■ FEATURES:

Removable column kit for modules 300/400 and 450 mm wide.

Height: 1900-2300 mm.

Kit includes: column frame with front fixing, interior racks, guideways for full extension and soft closing, for module bottom and upper assembly.

With 3D adjustment system for perfect fit. Maximum load 120 kg.

Finish: chrome steel.

ALTURA Height	MÓDULO Cabinet	CESTOS Basquets	CÓDIGO Code
1900 - 2300	300	6	9901207
1900 - 2300	400	6	9901209
1900 - 2300	450	6	9901210



KIT DESPENSA EXTRAIBLE LATERAL PLUS

Lateral removable pantry kit Plus

■ CARACTERÍSTICAS TÉCNICAS:

Kit despensa extraíble lateral para módulo de 600 mm ancho.

Altura kit: 1900 mm.

Con sistema de cierre amortiguado. Extracción del sistema al mismo tiempo que se abre la puerta, izquierda o derecha. Cestas en acero adaptable en altura.

Carga dinámica 20 kg. Bastidor frontal, 80 kg. bastidor interior.

Acabado: acero cromo.

■ FEATURES:

Lateral removable pantry kit for modules 600 mm wide and 1900 mm height.

With soft closing system. The same extraction system time the door opens left or right. Adaptable steel baskets at the desired height.

Dynamic load 20 kg front fame, 80 kg interior frame.

Finish: chrome steel.

ALTURA Height	MÓDULO Cabinet	CESTOS Basquets	CÓDIGO Code
1900	600	6 + 6	9905442



KIT BOTELLERO EXTRAIBLE COMPACT

Removable bottle rack kit Compact

■ CARACTERÍSTICAS TÉCNICAS:

Kit cesto frontal para montaje bajo fregadero, con guías correderas Quadro
 Kit botellero extraíble con base de melamina blanca para módulos de 150
 mm de ancho. Carga dinámica 15 kg.
 Medidas 533x108x490 mm.alto, ancho y fondo. Extracción total.
 Acabado: acero cromo.

■ FEATURES:

Removable bottle rack kit with white melamine base for modules 150 mm wide.
 Dynamic load 15 kg.
 Dimensions 533x108x490 mm. height, width and depth. Full extension.
 Finish: chrome steel.



DESCRIPCIÓN / Description	CÓDIGO / Code
Kit botellero Compact 150 / Bottle rack kit Compact 150	9903068

KIT BOTELLERO PANERO EXTRAIBLE COMPACT

Removable bottle-bread rack kit Compact

■ CARACTERÍSTICAS TÉCNICAS:

Kit botellero panero extraíble con base de melamina blanca para
 módulos de 300 mm de ancho. Carga dinámica 30 kg.
 Medidas 543x268x490 mm.alto, ancho y fondo. Extracción total.
 Acabado: acero cromo.

■ FEATURES:

Removable bottle-bread rack kit with white melamine base for modules
 300 mm wide.
 Dynamic load 30 kg.
 Dimensions 543x268x490 mm. height, width and depth. Full extension.
 Finish: chrome steel.



DESCRIPCIÓN / Description	CÓDIGO / Code
Kit botellero panero Compact 300 / Bottle-bread kit 300	9903311

KIT BANDEJAS SEMICIRCULARES 180° COMPACT 700-800 ALTURA

180° semi-round tray kit Compact 700 and 800 height

■ CARACTERÍSTICAS TÉCNICAS:

Conjunto de bandejas semicirculares unidas mediante eje regulable
 de 630 > 730 mm
 Conjunto de bandejas semicirculares unidas mediante eje regulable
 de 730 > 780 mm
 para módulos de rincón ciego alturas 700/800 mm con ancho 1000 y
 puerta abisagrada
 450-500 mm.
 Carga dinámica: 20 kg por bandeja.
 Acabado: acero cromo.

■ FEATURES:

Semi-round tray kit joined by axis 630 > 730 mm for blind corner modules
 700 mm
 Semi-round tray kit joined by axis 730 > 780 mm for blind corner modules
 800 mm
 height of 1000 mm wide and 450-500 mm hinged door.
 Dynamic load: 20 kg per tray.
 Finish: chrome steel.



DESCRIPCIÓN / Description	CÓDIGO / Code
Kit bandejas Compact 450 (700) / Compact tray kit 450 (700)	9903749
Kit bandejas Compact 450 (800) / Compact tray kit 450 (800)	9905431
Kit bandejas Compact 500 (700) / Compact tray kit 500 (700)	9903750
Kit bandejas Compact 500 (800) / Compact tray kit 500 (800)	9905432

KIT BANDEJAS GIRATORIAS 270° COMPACT 700-800 ALTURA

270° rotating tray kit Compact 700 and 800 height

■ CARACTERÍSTICAS TÉCNICAS:

Conjunto de bandejas circulares unidas mediante un eje regulable de 630 > 730 mm

Conjunto de bandejas circulares unidas mediante un eje regulable de 730 > 780 mm

para módulo bajo rincón angular altura **700/800 mm** y diámetros de: Ø 700 y Ø 820 mm.

Carga dinámica: 20 kg por bandeja.

Acabado: acero cromo.

■ FEATURES:

Round tray kit joined by central axis 630 > 730 mm for angled corner modules

Round tray kit joined by central axis 730 > 780 mm for angled corner modules height 700/800 mm with diameters: Ø 700 and Ø 820 mm.

Dynamic load: 20 kg per tray.

Finish: chrome steel.



DESCRIPCIÓN / Description	CÓDIGO / Code
Kit Bandejas Compact 270° Ø 710 (700) / 270° tray kit Ø 710 (700)	9903751
Kit Bandejas Compact 270° Ø 710 (800) / 270° tray kit Ø 710 (800)	9905433
Kit Bandejas Compact 270° Ø 810 (700) / 270° tray kit Ø 810 (700)	9903752
Kit Bandejas Compact 270° Ø 810 (800) / 270° tray kit Ø 810 (800)	9905434

BANDEJAS DESLIZANTES DOLPHIN COMPACT

Dolphin Compact sliding pull-out

■ CARACTERÍSTICAS TÉCNICAS:

Conjunto de bandejas deslizantes de extracción independientes para módulo de rincón ciego de **700 y 800 mm altura**, con puerta abisagrada y terminaciones izquierda o derecha. Con sistema de apertura y cierre asistido.

Ancho módulos mínimo 900 mm para puertas 400 y 450 mm ancho.

Ancho módulos mínimo 1000 mm para puertas 500 y 600 mm ancho.

Con base melamina blanca. Carga máxima 20 kg por bandeja.

Acabado: acero cromo.

■ FEATURES:

Sliding pull-out with independent extraction, for blind corner module with 700 and 800 mm heights and hinged door. Left and right ends. Easy opening, closing system.

Modules minimum 900 mm for 400 and 450 mm doors size.

Modules minimum 1000 mm for 500 and 600 mm doors size.

With white melamine base. Dynamic load: 20 kg per tray.

Finish: chrome steel.



Grafito / Graphite

DESCRIPCIÓN / Description	CÓDIGO / Code
Bandejas Dolphin Compact 400 derecha / 400 trays right	9907110
Bandejas Dolphin Compact 400 izquierda / 400 trays left	9907111
Bandejas Dolphin Compact 450 derecha / 450 trays right	9907112
Bandejas Dolphin Compact 450 izquierda / 450 trays left	9907113
Bandejas Dolphin Compact 500 derecha / 500 trays right	9907114
Bandejas Dolphin Compact 500 izquierda / 500 trays left	9907115
Bandejas Dolphin Compact 600 derecha / 600 trays right	9907116
Bandejas Dolphin Compact 600 izquierda / 600 trays left	9907117

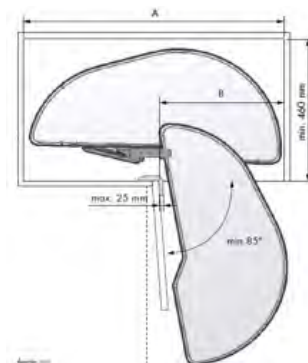

Derecho / Right

F. FREGADEROS Y GRIFOS

Sinks and taps



TOP FORM

FREGADERO BAJO ENCIMERA ROMA

Undermount sink ROMA

■ CARACTERÍSTICAS TÉCNICAS:

Fregadero de una cubeta bajo encimera inox.
Medidas disponibles: 450x450 y 500x450 mm.

■ FEATURES:

Single-bowl stainless steel undermount sink.
Available sizes: 450x450 and 500x450 mm.

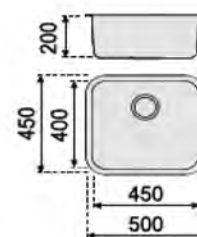
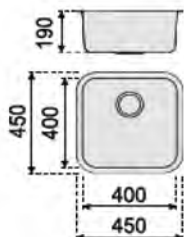

DESCRIPCIÓN Description	CÓDIGO Code
Fregadero Roma 450x450 mm / Roma 450x450 mm sink	9909312
Fregadero Roma 500x450 mm / Roma 500x450 mm sink	9909313

**FREGADERO BAJO ENCIMERA BERLÍN**

Undermount sink BERLIN

■ CARACTERÍSTICAS TÉCNICAS:

Single-bowl stainless steel undermount sink.
Medida disponible: 490x440 mm.

■ FEATURES:

Single-bowl stainless steel under worktop sink.
Available size: 490x440 mm.



DESCRIPCIÓN Description	CÓDIGO Code
Fregadero Berlín 450x450 mm / Berlín 450x450 mm sink	9909385

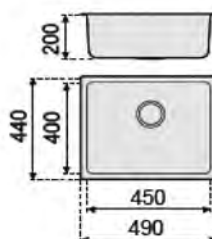

FREGADERO DE ENCASTRAR TOKIO

Drop-in sink TOKIO

■ CARACTERÍSTICAS TÉCNICAS:

FFregadero de una cubeta para encastrar inox.
Medida disponible: 500x500 mm.

■ FEATURES:

Single-bowl stainless steel drop-in sink.
Available size: 500x500 mm.



DESCRIPCIÓN Description	CÓDIGO Code
Fregadero Tokio 500x500 mm / Tokio 500x500 mm sink	9909314

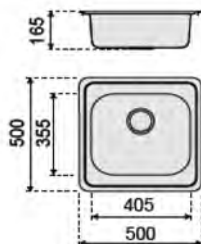

FREGADERO DE ENCASTRAR ESTAMBUL

Drop-in sink ESTAMBUL

■ CARACTERÍSTICAS TÉCNICAS:

Fregadero de una cubeta para encastrar inox.
Medida disponible: 490 mm Ø.

■ FEATURES:

Single-bowl stainless steel drop-in sink.
Available size: 490 mm Ø.



DESCRIPCIÓN Description	CÓDIGO Code
Fregadero Estambul 490 mm / Estambul 490 mm sink	9909388



FREGADERO DE ENCASTRAR VIENA*Drop-in sink VIENA***■ CARACTERÍSTICAS TÉCNICAS:**

Fregadero de una cubeta + escurridor para encastrar inox.
Medida disponible: 800x480 mm.

■ FEATURES:

Single-bowl + drainer stainless steel drop-in sink.
Available size: 800x480 mm.

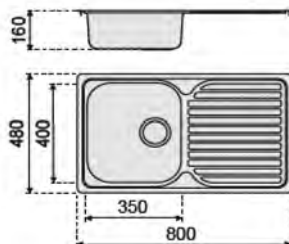

DESCRIPCIÓN <i>Description</i>	CÓDIGO <i>Code</i>
Fregadero Viena 800x480 mm / Viena 800x480 mm sink	9909393

**FREGADERO DE ENCASTRAR DUBLÍN***Drop-in sink DUBLIN***■ CARACTERÍSTICAS TÉCNICAS:**

Fregadero de dos cubeta para encastrar inox.
Medida disponible: 800x480 mm.

■ FEATURES:

Double-bowl stainless steel drop-in sink.
Available size: 800x480 mm.



DESCRIPCIÓN <i>Description</i>	CÓDIGO <i>Code</i>
Fregadero Dublín 800x480 mm / Dublin 800x480 mm sink	9909395

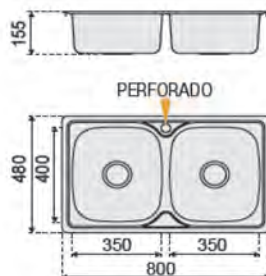

FREGADERO DE ENCASTRAR MADRID

Drop-in sink MADRID

■ CARACTERÍSTICAS TÉCNICAS:

Fregadero de una cubeta + escurridor para encastrar inox.

Medida: 860x500 mm.

Fregadero de dos cubetas + escurridor para encastrar inox.

Medida: 970x500 mm.

■ FEATURES:

Single-bowl + drainer stainless steel drop-in sink. Size 860x500 mm.

Double-bowl + drainer stainless steel drop-in sink. Size 970x500 mm.



DESCRIPCIÓN / Description	CÓDIGO / Code
Fregadero Madrid 860x500 mm / Madrid 860x500 mm sink	9909396
Fregadero Madrid 970x500 mm / Madrid 970x500 mm sink	9909397

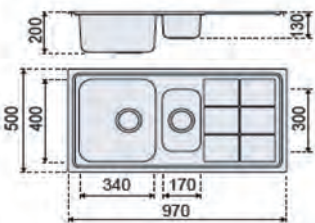
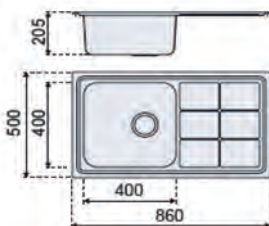

FREGADERO DE ENCASTRAR NEW YORK

Drop-in sink NEW YORK

■ CARACTERÍSTICAS TÉCNICAS:

Fregadero de una cubeta + escurridor para encastrar inox.

Medida: 860x500 mm.

Fregadero de dos cubetas + escurridor para encastrar inox.

Medida: 1000x500 mm.

■ FEATURES:

Single-bowl + drainer stainless steel drop-in sink. Size 860x500 mm.

Double-bowl + drainer stainless steel drop-in sink. Size 1000x500 mm.



DESCRIPCIÓN / Description	CÓDIGO / Code
Fregadero New York 860x500 mm / New York 860x500 mm sink	9909315
Fregadero New York 1000x500 mm / New York 1000x500 mm sink	9909316

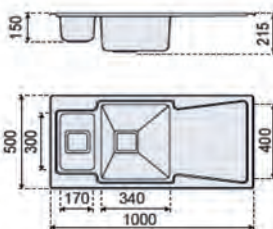
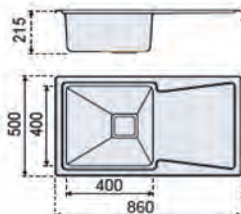

GRIFO DE ENCASTRE SENADrop-in tap *SENA***■ CARACTERÍSTICAS TÉCNICAS:**Grifo para encastrar cromado.
Componentes: Kit de montaje incluido.**■ FEATURES:**Chrome drop-in tap.
Components: mounting kit included.

DESCRIPCIÓN Description	CÓDIGO Code
Grifo Sena cromado / Sena chrome tap	9909399

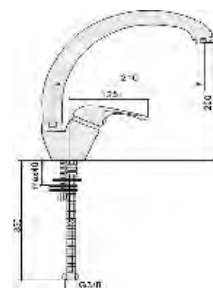
**GRIFO DE ENCASTRE DANUBIO**Drop-in tap *DANUBIO***■ CARACTERÍSTICAS TÉCNICAS:**Grifo para encastrar cromado.
Componentes: Kit de montaje incluido.**■ FEATURES:**Chrome drop-in tap.
Components: mounting kit included.

DESCRIPCIÓN Description	CÓDIGO Code
Grifo Danubio cromado / Danubio chrome tap	9909401

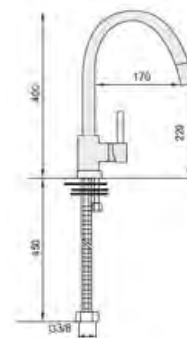
**GRIFO DE ENCASTRE TÁMESIS**Drop-in tap *TAMESIS***■ CARACTERÍSTICAS TÉCNICAS:**Grifo para encastrar cromado.
Componentes: Kit de montaje incluido.**■ FEATURES:**Chrome drop-in tap.
Components: mounting kit included.

DESCRIPCIÓN Description	CÓDIGO Code
Grifo Támesis cromado / Tamesis chrome tap	9909403

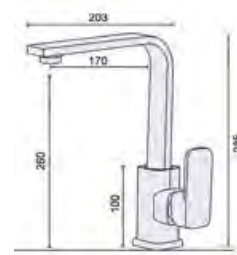



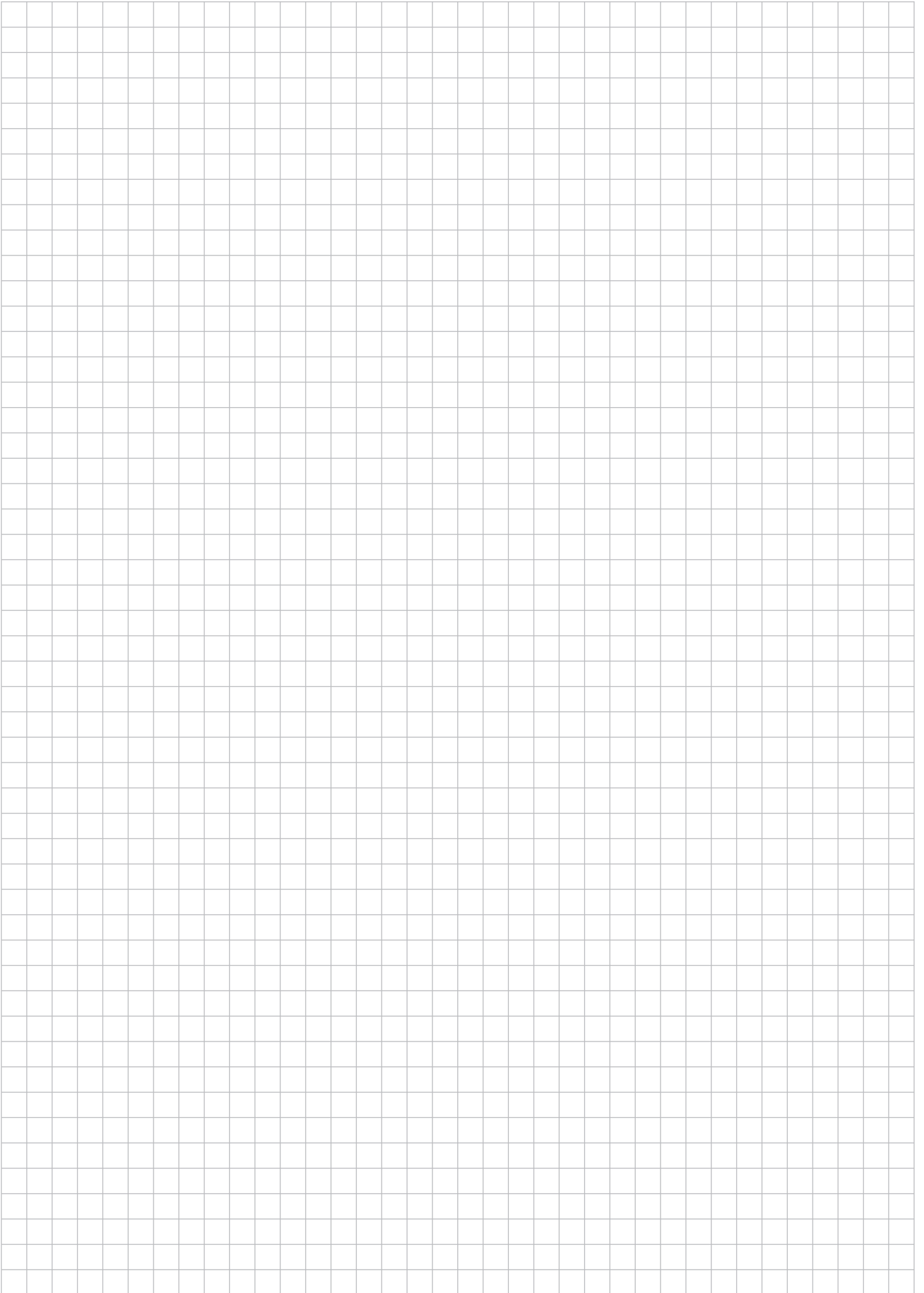



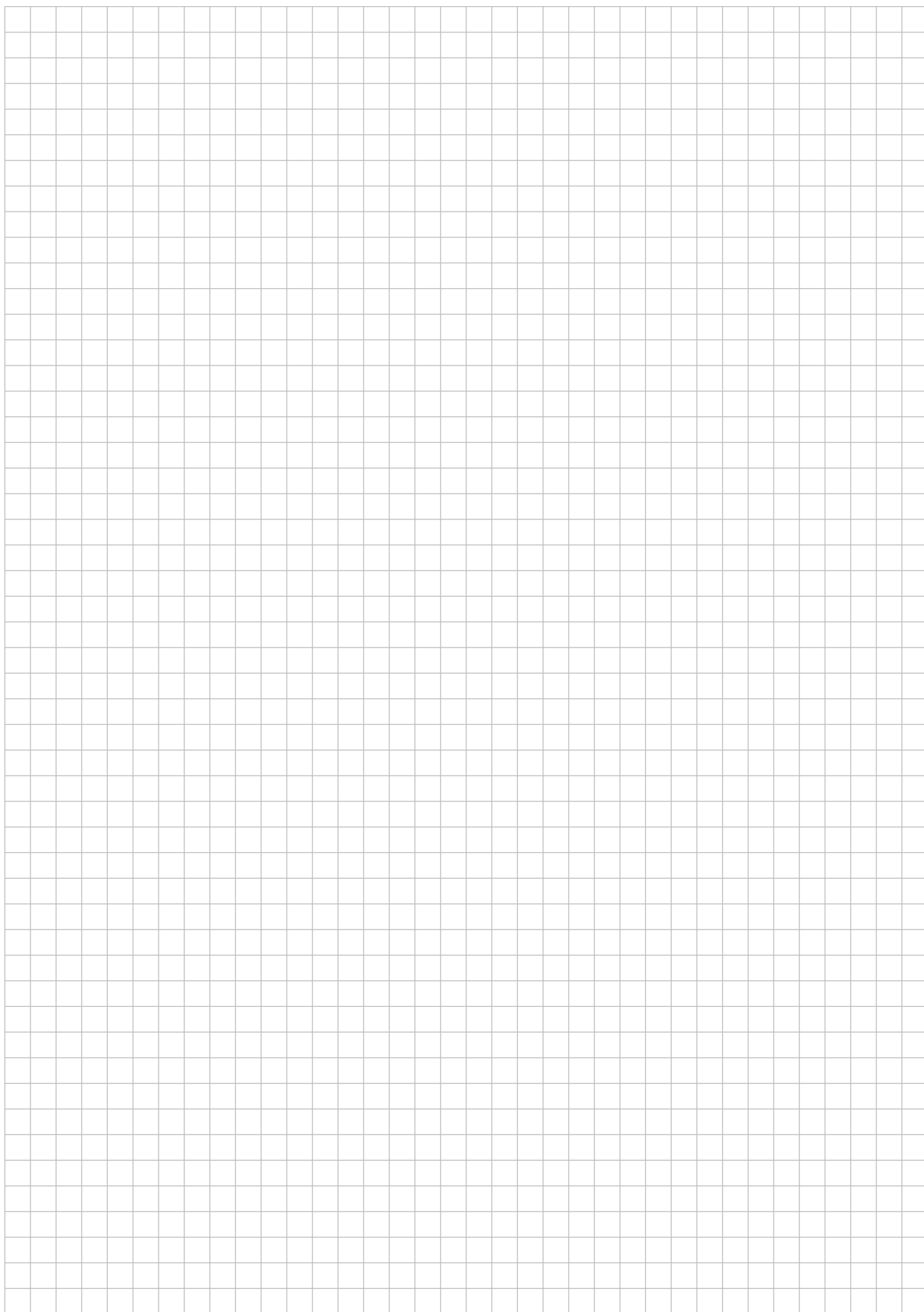



TOP FORM

1970 - 2020
ANIVERSARIO
50

Take the challenge



TOP FORM

BY **TOP FORM**
GROUP

Oficinas centrales / Head offices
Ctra. Yuncos a Cedillo del Condado Km 2,8
45210 Yuncos-Toledo (Spain)
Tel.: (+34) 925 021 200



www.topformgroup.com

informacion@topformgroup.com