

ALNIC CENTER

Bienvenido
a tu lugar de trabajo



Bienvenido a tu lugar de trabajo



Vive



Crea



Comparte



1

¿Qué es un
Alvic Center?

p.2

2

Cocinas, Baños
Armarios & Hogar

p.10

3

Diseña tu proyecto

p.58

Comparte





— 1 —

¿Qué es un Alvic Center?

Alvic Center es un espacio para profesionales de la construcción, reforma, carpinteros, interioristas y arquitectos.

Un lugar donde encontrarás **soluciones profesionales** para hacer realidad tus proyectos, ofreciendo a tus clientes una **experiencia única y materiales de alta calidad directos del fabricante.**

Más de 35 centros en España y Francia.

Haz realidad tus proyectos



Armarios



Hogar



Ponemos a tu disposición

Exposición

+200 m² de showroom para mostrar las últimas tendencias en cocinas, baños y armarios.

Zona dedicada a probar: donde puedes tocar y experimentar puertas, tiradores, encimeras, interiorismo y mucho más.



Asesoramiento

Nuestro equipo tiene una gran experiencia técnica en producto, diseño y planificación.

Te pueden ayudar con la preparación de presupuestos y acompañarte en la gestión de pedidos.

Selección de productos líderes en el mercado

Directos del fabricante

Acceso a una amplia colección de productos y complementos de primer nivel para realizar tu proyecto. Desde los materiales y diseños de alta calidad Alvic, hasta los catálogos de producto de marcas líderes como Cosentino, Neolith, Blum, Rodi, Franke, Bosch, Siemens, Balay, etc

¡Todo en un mismo sitio!



Zonas de trabajo

Para que puedas trabajar a gusto y reunirte con clientes, ponemos a tu disposición un espacio con recepción, áreas de trabajo y exposición. ¡Queremos que te sientas como en casa!

Un almacén gestionado por nuestros expertos y equipado con maquinaria de corte y canteo para darte una solución personalizada y rápida para tu proyecto.

¿Por qué elegir Alvic?

Alvic es la marca líder en fabricación de paneles decorativos y componentes para el sector del mueble y de la decoración.

Nuestros productos están avalados por más de 50 años de innovación continua, y pruebas de calidad exigentes.

Alta calidad

La calidad certificada de nuestros productos nos avala, llevamos más de 50 años innovando para lograr superficies de alto nivel de acabado y con excelentes propiedades físico-mecánicas.

Todos nuestros productos se someten a pruebas muy exigentes para garantizar su máxima calidad: resistencia al rayado, a la humedad, al calor seco, a la abrasión, etc.

Por ello cuentan con un certificado de garantía de 5 años.

Diseños

Una amplia gama de diseños para responder a todas las necesidades de tus clientes.

Colores de tendencia y atemporales, diferentes texturas y efectos de maderas, piedras, mármoles, etc.

Alvic cuenta con tres tecnologías referentes en el mercado que, aplicadas a las superficies, permiten distintos acabados: Luxe -alto brillo-, Zenit -mate y tacto sedoso- y Synchron -texturizado y efecto natural-.

Sostenibilidad

La calidad certificada de nuestros productos nos avala. 50 años innovando para ti. Los tableros están fabricados en un 95% con material sostenible y certificado PEFC.



Servicio



Gran variedad de superficies

Más de 150 referencias disponibles para todos tus proyectos.



Rapidez

Entregamos tus pedidos justo a tiempo para dar una respuesta rápida y personalizada a tus clientes.



0 Stock

¡Olvídate de tener stock y pide solo la cantidad que necesitas!

Contamos con un almacén donde realizar la recepción del material y tenerlo preparado cuando lo necesites.



Entrega perfecta

Recibe tu pedido con el mueble montado o todo el despiece preparado y solo preocúpate de la instalación o del montaje.

Vive



— 2 —

Cocinas, Baños Armarios & Hogar

Hacemos realidad tu proyecto
aportando soluciones, diseños y calidad
en materiales para cada una
de las habitaciones de la casa.

2.1

Cocinas

¡Bienvenido al corazón de la casa!

Creamos cocinas donde vivir, compartir momentos y disfrutar. Descubre nuestra propuesta de diseños de tendencia que se adapta a todos los espacios y estilos de vida.







Encimera: R3-Supra EP-154Y-YO Porcelain 01 Gold
Puertas: Sincron Nogal Rosales 03
Revestimiento: Zenit Metal Plus Light Gold
Tiradores: Gola
Vitrina: Zen
Electrodomésticos: Hornos Siemens, Placa Bora Classic



Sincron Nogal Rosales 03



R3-Supra EP-154Y-YO Porcelain 01 Gold



Zenit Metal Plus Light Gold



Zenit Gris Nube SM

R3-Supra EP-151-ST Mármol Marquina Apomazado

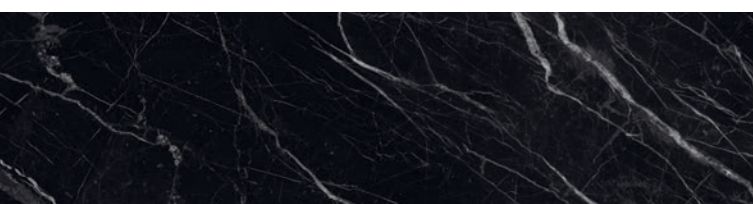

Encimera: R3-Supra EP-151-ST Mármol Marquina Apomazado
Puertas: Zenit Gris Nube SM
Revestimiento: EP-151-ST Mármol Marquina Apomazado
Tiradores: Gola y Finger-Pull
Electrodomésticos:
Placa Bosch serie 4
Microondas Bosch serie 6
Campana Balay telescópica 3BT267MX



Encimera: R3-Supra EP-147-PE Porcelánico Carbón
Puertas: Luxe Plus Azul Marino
Vitrina: Zen

Electrodomésticos:
Microondas Balay 3WMX1918 Frigorífico combi Bosch serie 6
Horno Balay 3HB4841X1 Vinoteca Gaggenau serie 200





Luxe Plus Azul Marino

R3-Supra EP-147-PE Porcelánico Carbón







Encimera:
R3-Supra EP-002-SF Blanco Soft

Puertas:
Synchron Lakeland Oak 03 y
Zenit Gris Plomo SM

Tiradores:
Mallorca Inox

Electrodomésticos:
Horno Bosch serie 8
Horno Microondas Bosch serie 8
Placa Bosch serie 4









Encimera:
Cosentino Siberia

Puertas:
Zenit Verde Salvia y
Sincron Nogal Rosales 02

Revestimiento:
Cosentino Siberia

Tiradores:
T-64

Electrodomésticos:
Horno Bosch serie 8
Campana Bosch serie 4
Placa Bosch serie 4





Zenit Verde Salvia SM



Syncron Nogal Rosales O2





Encimera:
R3-Supra EP-092-IS Cemento Oscuro

Puertas:
Quadro Sincron Como Ash 02

Tiradores:
T-61 Plata Vieja

Electrodomésticos:
Horno Bosch serie 8
Horno Microondas Bosch serie 8
Placa Bosch serie 4
Campana Bosch serie 4





R3-Supra EP-092-IS Cemento Oscuro



Sincron Como Ash 02





Encimera: R3-Supra EP-151-ST Mármol Marquina Apomazado
Puertas: Sincron Porcelain O3 Silver JA y Zenit Blanco SM
Tiradores: Madeira Negro
Electrodomésticos: Frigorífico americano Bosch serie 4
Estantes: Referencia E3NE/E3150 Antracita

Comparte. Vive. Crea

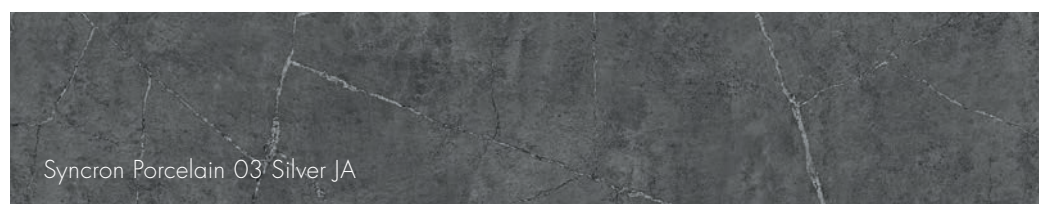

Syncon Porcelain O3 Silver JA

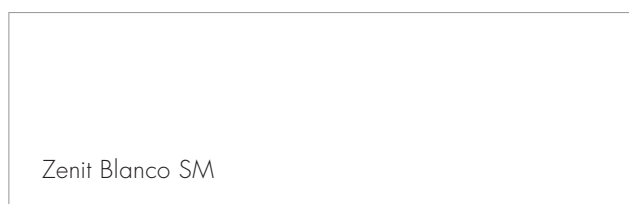

Zenit Blanco SM



R3-Supra EP-151-ST M3rml Marquina Apomazado

Encimera: Cosentino Ethereal Dusk
Puertas: Synchron Anniversary Oak 02 y Zenit Blanco SM
Tiradores: Finger-Pull
Vitrina: Zen

Electrodomésticos:
Campana Balay 3BC497GN
Placa Bosch serie 4
Horno y microondas Gaggenau serie 400









Sincron Anniversary Oak 02

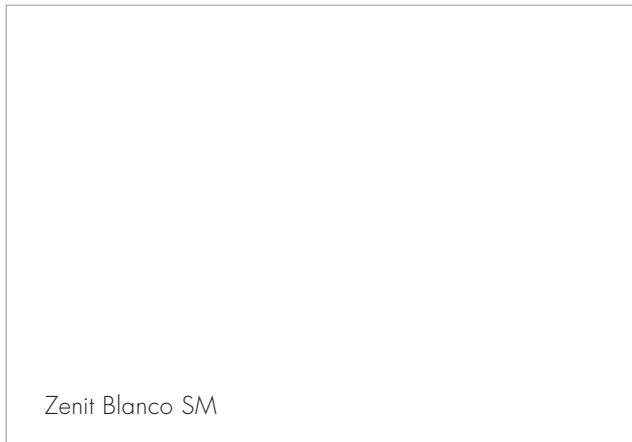

Zenit Blanco SM





Encimera:
R3-Supra EP-116-BR M3rml Markina BR

Puertas:
Sincron Woodline 03

Revestimiento:
EP-116-BR M3rml Markina BR

Tiradores:
Ibiza Negro Mate

Vitrina:
Zen

Electrodom3sticos:
Placa Bosch serie 4
Hornos Siemens I1700



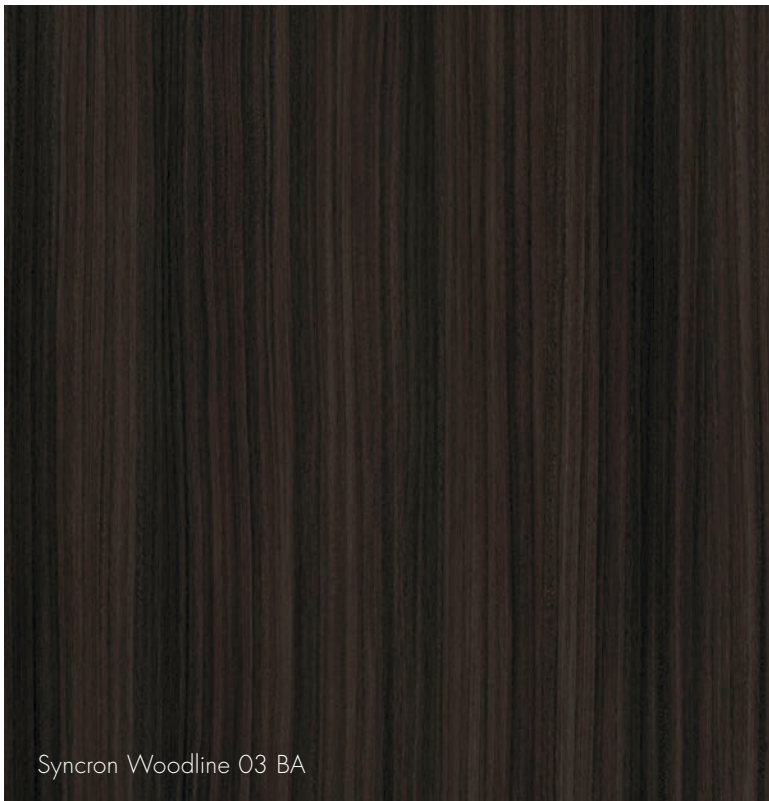
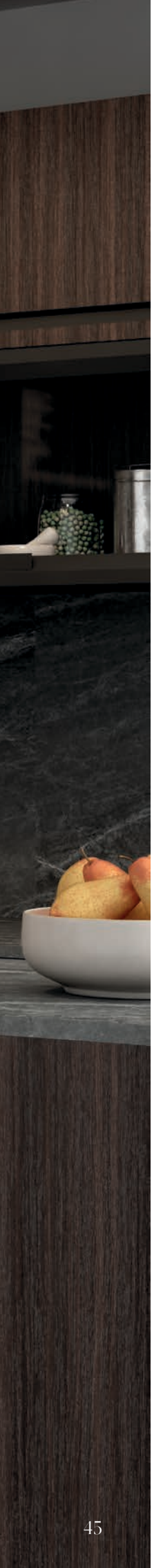

Sincron Woodline 03 BA

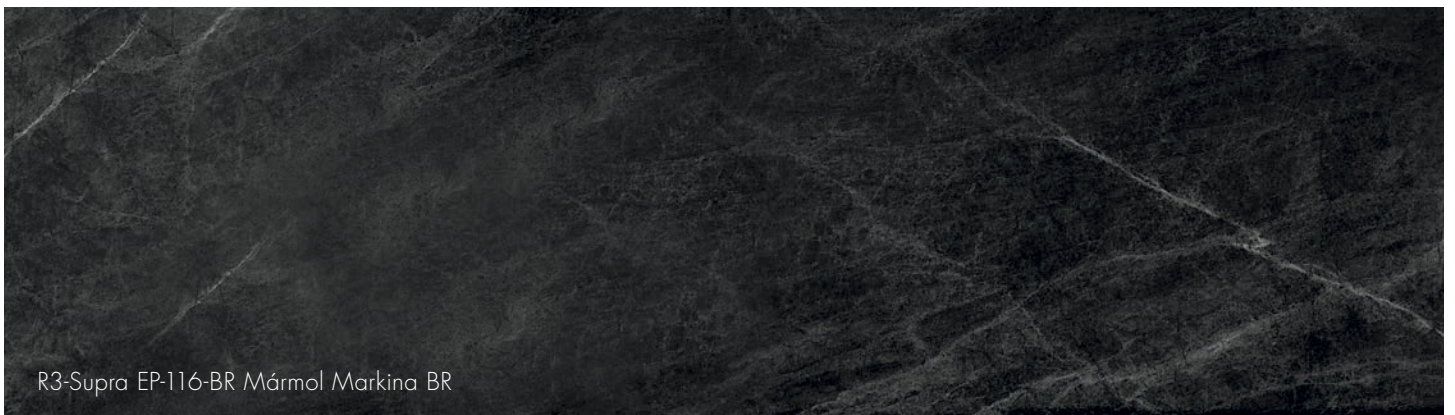

R3-Supra EP-116-BR Mármol Markina BR





Encimera:

R3-Supra EP-140-SM Mármol Versilia

Puertas:

Zenit Mármol Versilia SM y Zenit Blanco SM

Tiradores:

Gola

Vitrina:

Zen

Electrodomésticos:

Placa Siemens iq500

Horno Bosch serie 8

Horno Microondas Bosch serie 8



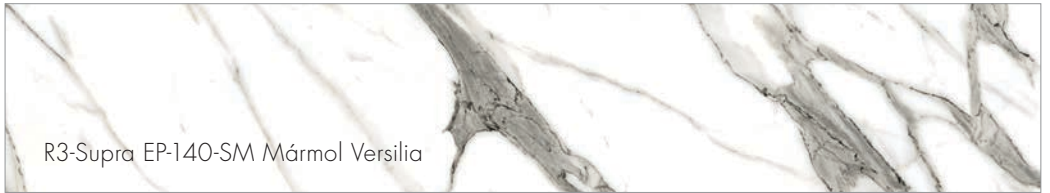
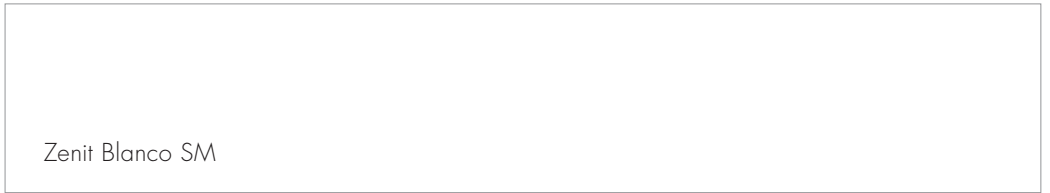
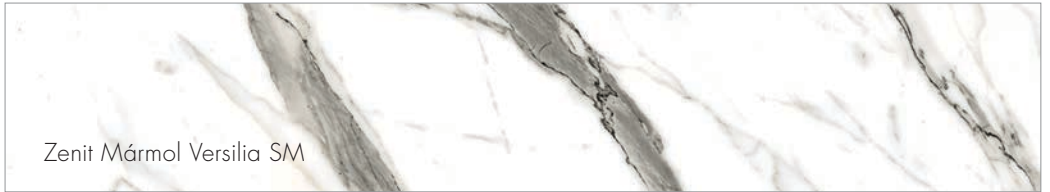

2.2

Baños

Nuestros muebles de baño aportan diseño, bienestar y funcionalidad al día a día.









Mueble Baño 1 cajón suspendido

Puertas: Sincron Nogal Rosales 03

Tiradores: Gola negro

Lavabo: Cerámico

Espejo: Halo Round Led



Sincron Nogal Rosales 03

2.3

Armarios

Diseñamos armarios a medida con alto nivel de acabado que se adaptan a todos los ritmos de vida.









Diseño interior: Nogal

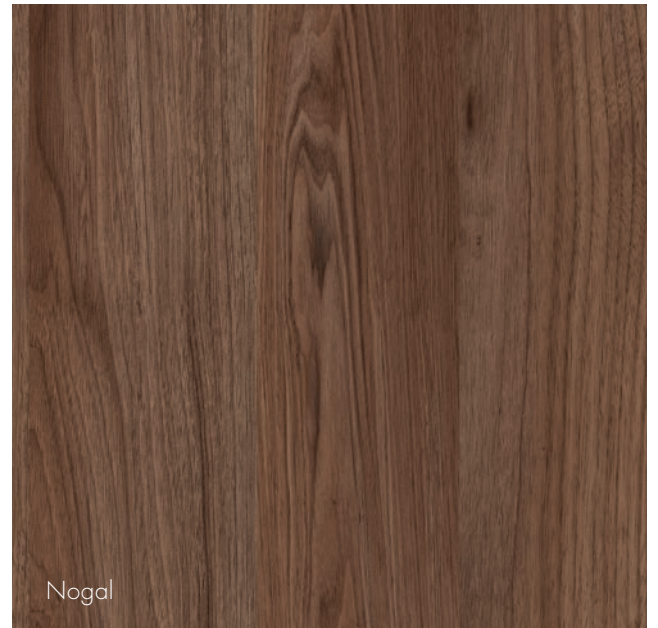

Nogal

Crea



— 3 —

Diseña tu proyecto

En Alvic Center tú eliges cómo será tu proyecto, paso a paso, y nuestro equipo de expertos te asesora en todo momento.

Diseña tu cocina a medida



Elige los acabados y colores



Elige las puertas



Elige el tirador



Elige la encimera



Elige el módulo







Elige los acabados y colores

LUXE

Superficie de alto brillo lacada con un extraordinario comportamiento físico-mecánico.
Exalta los diseños y aporta luminosidad.

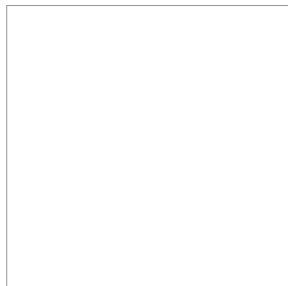

Blanco

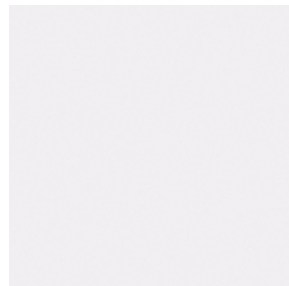

Blanco Polar *

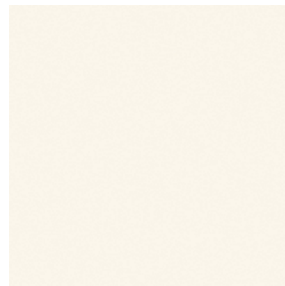

Ivory *

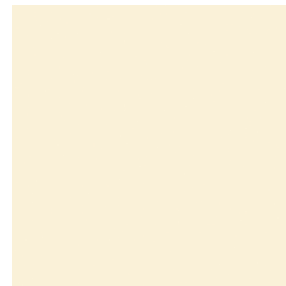

Magnolia



Cashmere

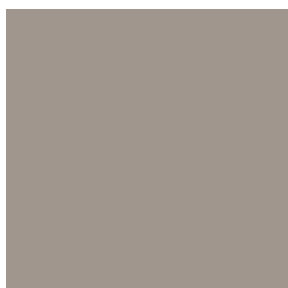

Gris-2

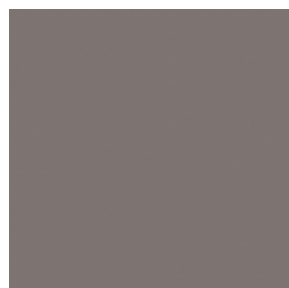

Basalto



Gris Nube



Gris Plomo

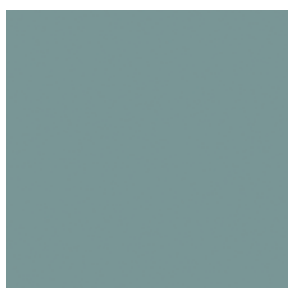

Agua Marina *



Verde Salvia **



Azul Índigo **



Azul Marino **

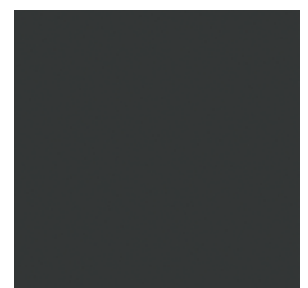

Antracita

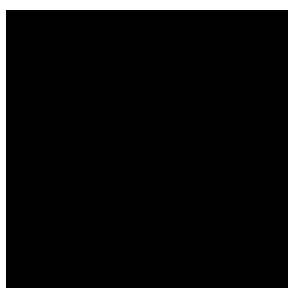

Negro



Rojo



Burdeos

* Disponible también en Luxe Plus.

Los colores de los diseños de paneles representados en este catálogo pueden variar respecto a la muestra física original debido a las técnicas de reproducción gráfica utilizadas en este catálogo.



Alto Brillo



Larga Durabilidad



Alta resistencia al rayado



Metallo 01 Silver

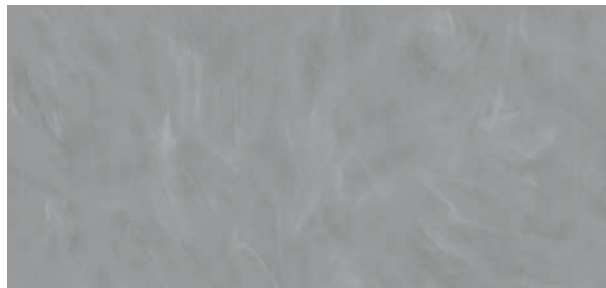

Steelboard Aluminio **

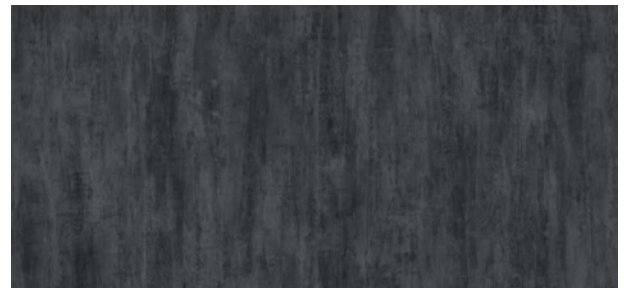

Metallo 04 Grafitt

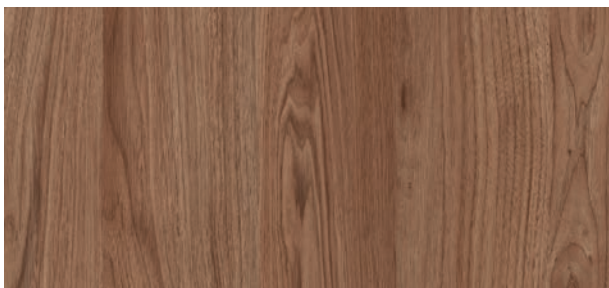

Nogal Rosales 02 **

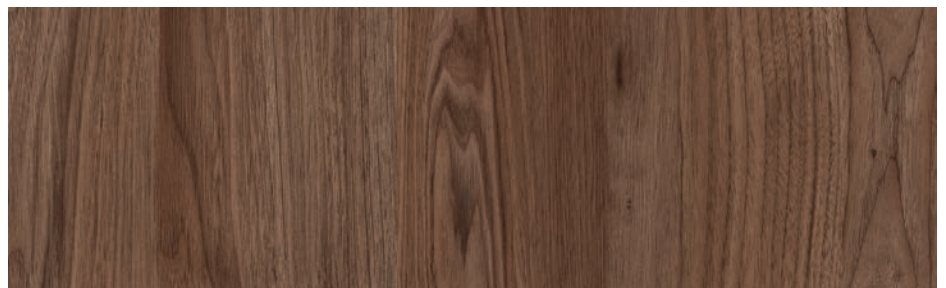

Nogal Rosales 03 **



Osiris Plata **

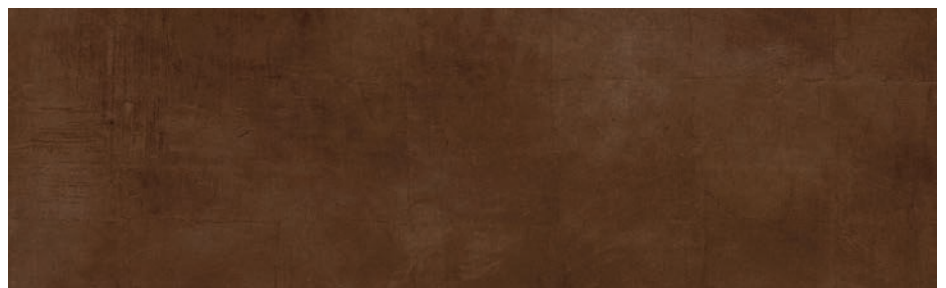

Cuzco Oro **



Porcelain 01 Gold **

** Disponible únicamente en Luxe Plus.



Elige los acabados y colores

ZENIT

Superficie lacada supermate con tacto sedoso y alta resistencia.

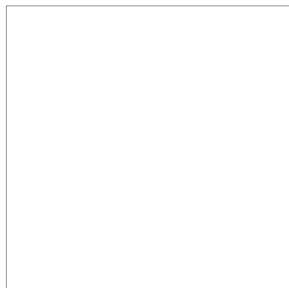

Blanco SM

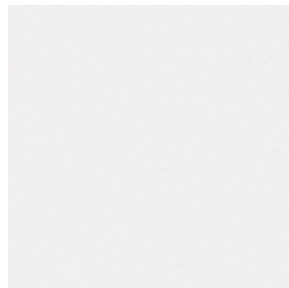

Blanco Polar SM

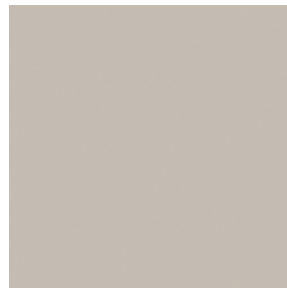

Cashmere SM

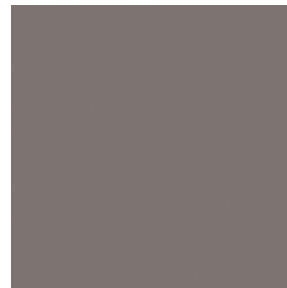

Basalto SM

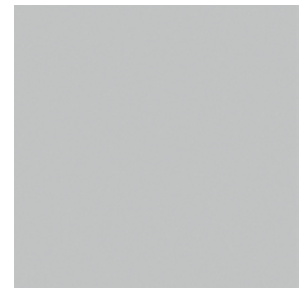

Gris Nube SM

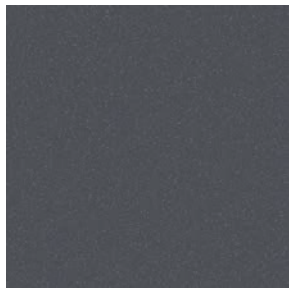

Gris Plomo SM



Antracita SM



Azul Marino SM



Azul Índigo SM



Agua Marina SM



Burdeos SM



Metal Plus Light Gold



Metal Plus Champagne

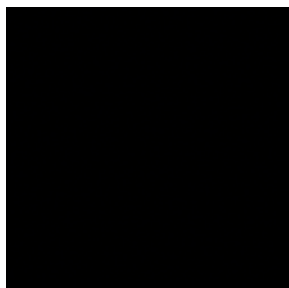

Negro SM

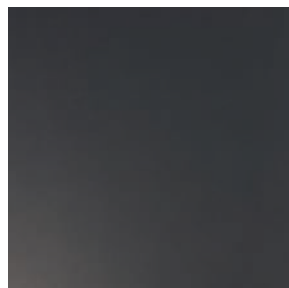

Metal Plus Titanio

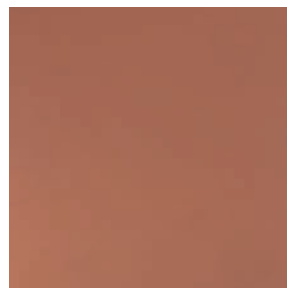

Metal Plus Copper

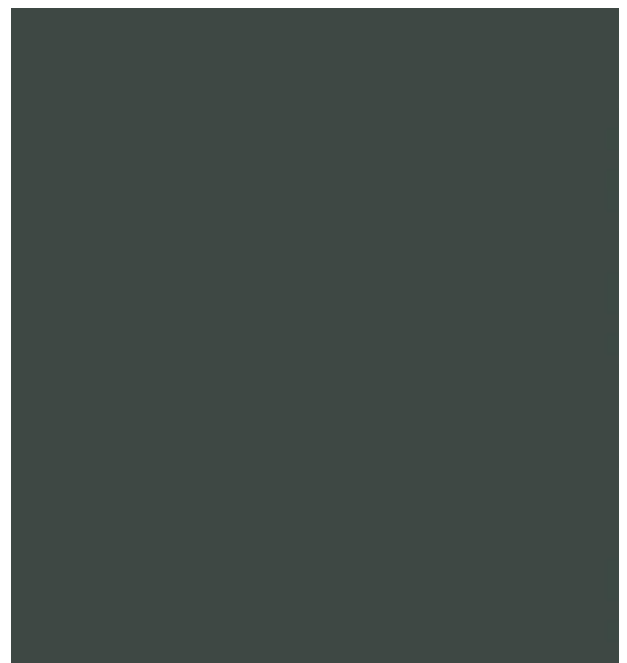

Verde Salvia SM



Tacto Seda



Larga Durabilidad



Resistencia al manchado

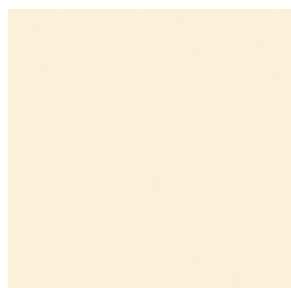

Magnolia SM



Metal Deco Cashmere



Metal Deco Gris Nube



Metal Deco Basalto



Metal Deco Antracita



Porcelain 01 Gold SM



Porcelain 02 Gold SM

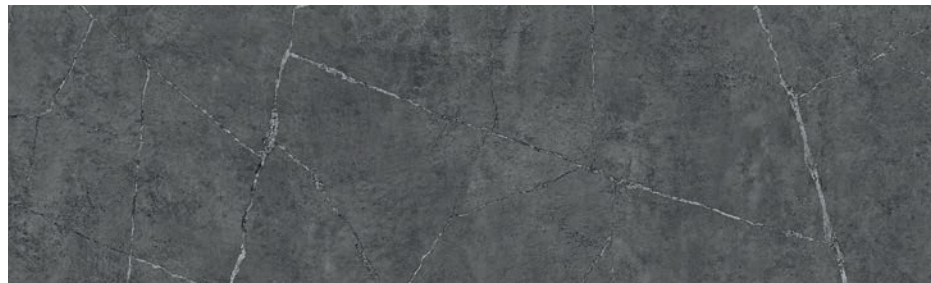

Porcelain 03 Silver SM



Osiris Plata SM



Steelboard Aluminio SM



Steelboard Grafito SM

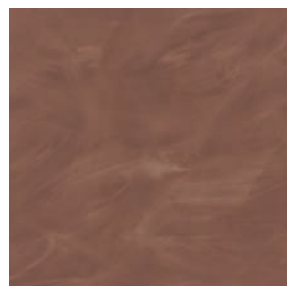

Steelboard Copper SM



Titan 03 SM

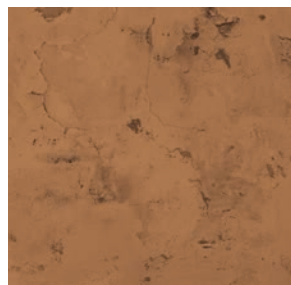

Osiris Cobre SM



Mármol Versilia SM

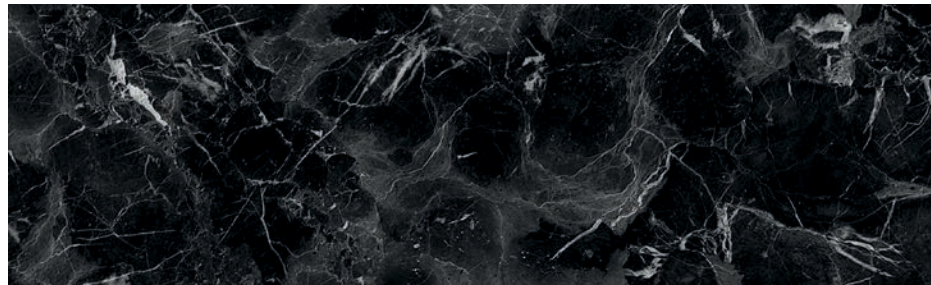

Oriental Black SM



Elige los acabados y colores

SYNCRON

Superficie texturizada en la que el diseño y acabado se complementan para una gran naturalidad y un alto nivel decorativo.

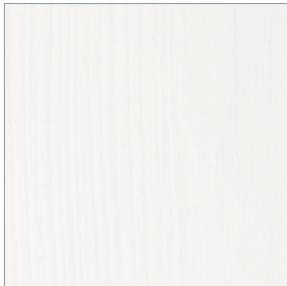

Blanco NW



Basalto NW



Spatt 01 Blanco VE



Spatt 02 Gris VE



Factory 02 CRT



Factory 01 CRT



Titan 01 PT

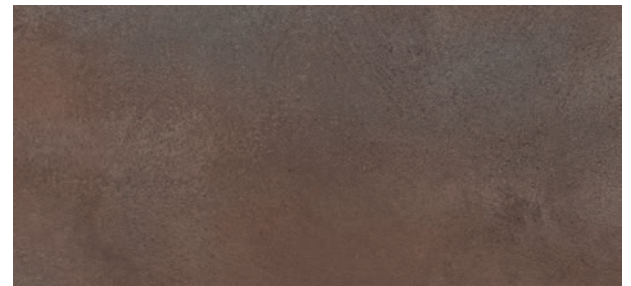

Titan 03 PT



Porcelain 01 Gold JA



Porcelain 02 Gold JA

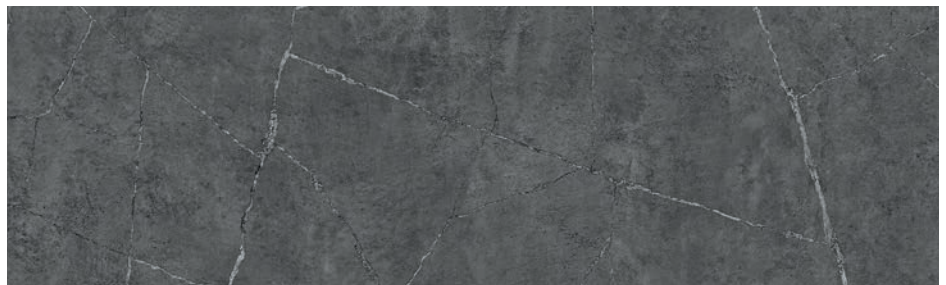

Porcelain 03 Silver JA



Acabados naturales



Tratamiento Antibacteria



Limpieza fácil



Ice Cream 01 JA



Ice Cream 02 JA



Royal Old Oak 01



Royal Old Oak 02



Roble Muratti 04

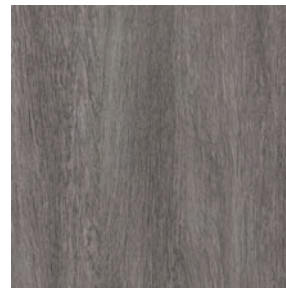

Roble Muratti 01



Roble Muratti 02



Lakeland Oak 01



Lakeland Oak 02



Lakeland Oak 03



Pino Rústico 801 SY



Pino Rústico 803 SY



Pino Rústico 802 SY

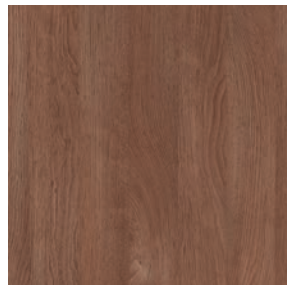

Pino Rústico 804 SY



Elige los acabados y colores

SYNCRON



Anniversary Oak 01 ***



Anniversary Oak 02 •



Anniversary Oak 03 •



Art Oak 01 •



Art Oak 03 •



Como Ash 01 •



Como Ash 02 •

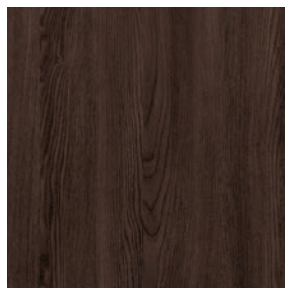

Como Ash 03 •



Nogal Rosales 01 •

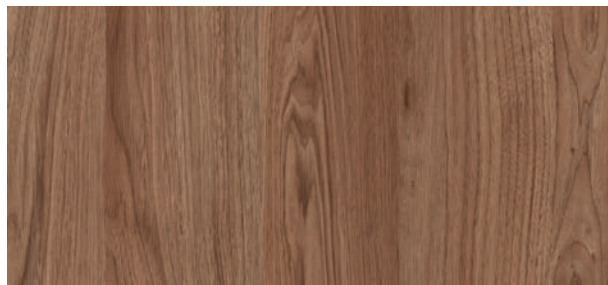

Nogal Rosales 02 •



Nogal Rosales 03 •

• Disponible únicamente en Registro.



Nocce 01



Nocce 02



Nocce 03



Olmo 01 JZ



Olmo 03 JZ



Woodline 01 BA

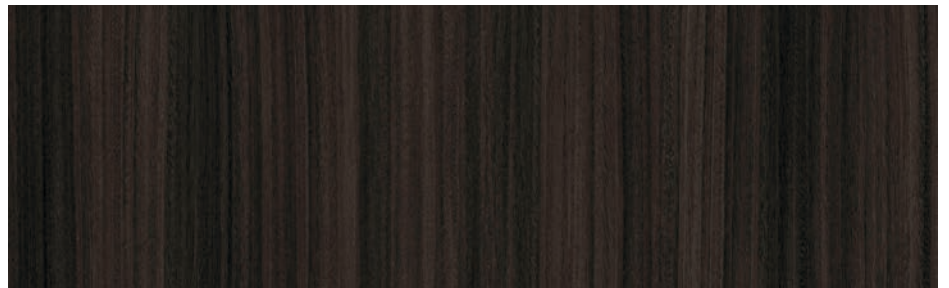

Woodline 03 BA



Carolina Pine

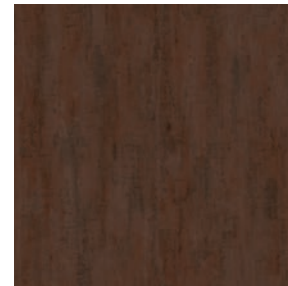

Oxid 03 Brown SS



Oxid 04 Grafitt SS

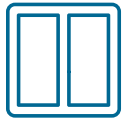

Elige las puertas

Una amplia gama de puertas para aportar distintos estilos a la cocina : moderno, rústico, clásico, nórdico, etc.

Puertas con push o tirador clásico



Pieza Estándar 4 Cantos



Quadro



Corfú

Puertas con tirador integrado

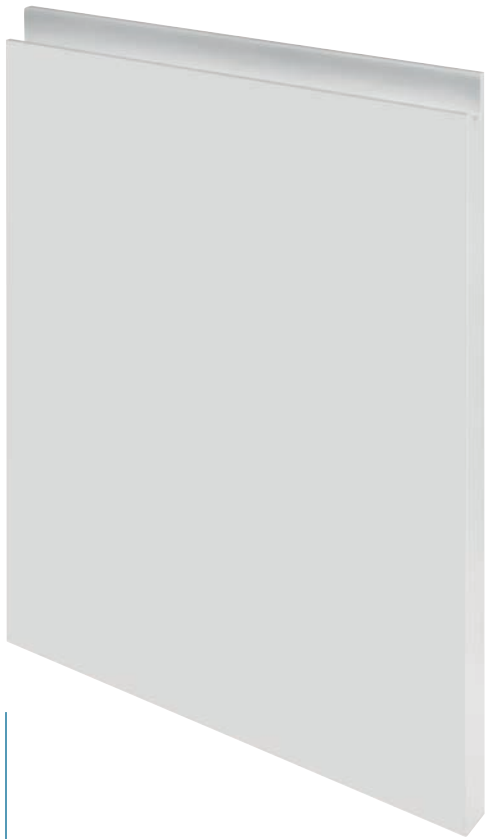

Finger-Pull

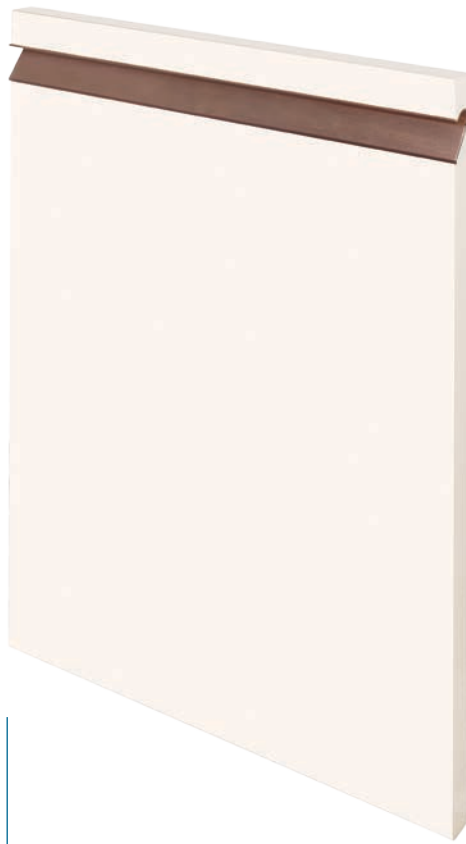

Tirador Integrado

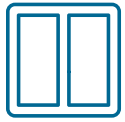

Elige el tirador integrado

Finger-Pull

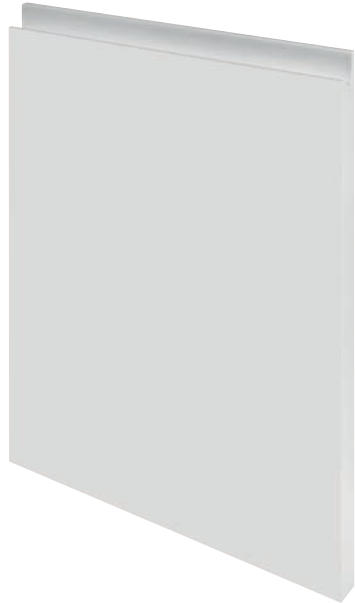
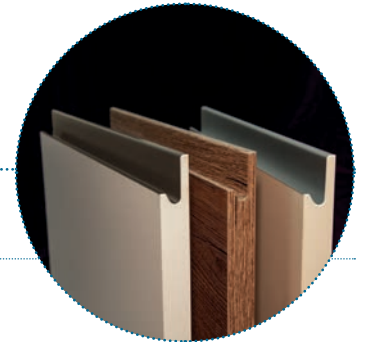

Disponible en los colores:

Luxe

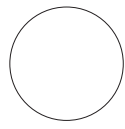

Blanco



Cashmere



Gris Nube



Magnolia

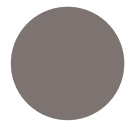

Basalto



Zenit

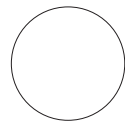

Blanco SM



Cashmere

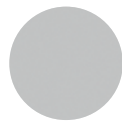

Gris Nube



Magnolia



Basalto



Negro



Syncron



Anniversary
Oak 01



Anniversary
Oak 02



Anniversary
Oak 03



Art
Oak 03



Carolina
Pine



Nocce
01



Nocce
03

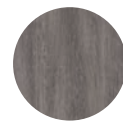

Roble Muratti
01



Roble Muratti
04



Tirador disponible en los acabados:



Color de
la puerta



Aluminio



Acero

Mallorca



SYNCRON Lakeland 03
Tirador integrado inox



Puerta disponibles en toda la gama de colores del catálogo.

Tirador disponible en los acabados:



Inox



Plata Mate



Negro Mate



Blanco Mate

Menorca

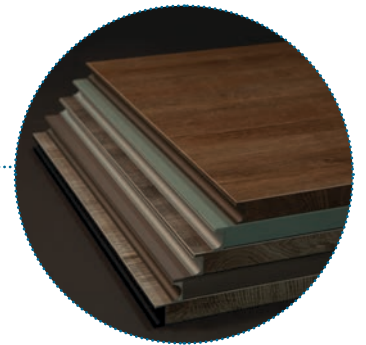

Puerta disponibles en toda la gama de colores del catálogo.

Tirador disponible en los acabados:



Inox



Plata Mate



Negro Mate



Blanco Mate

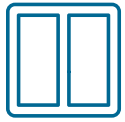

Elige el tirador integrado

Tenerife



SYNCRON Factory 01 CRT
Tirador integrado plata mate

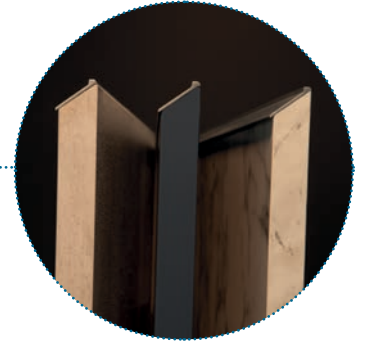

Puerta disponibles en toda la gama de colores del catálogo.

Tirador disponible en el acabado:



Plata Mate

Ibiza



LUXE Ivory
Tirador integrado cobre

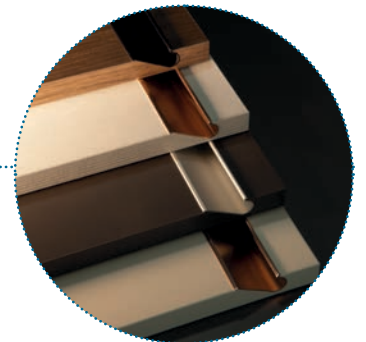

Puerta disponibles en toda la gama de colores del catálogo.

Tirador disponible en los acabados:



Inox



Plata Mate



Cobre



Negro Mate

Creta

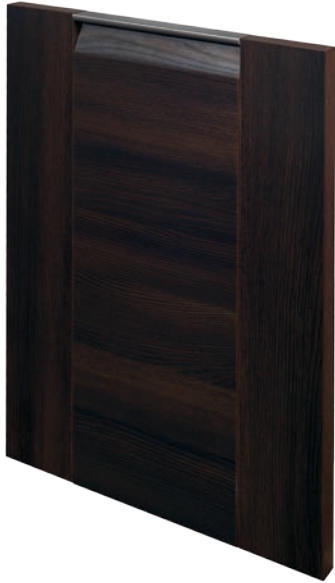

SYNCRON Como Ash 03
Tirador integrado inox

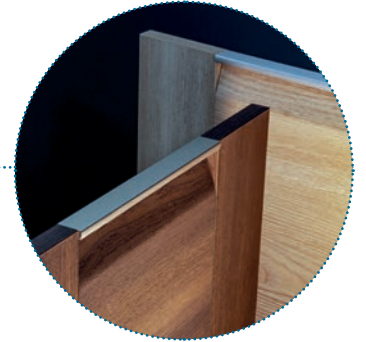

Disponible en los colores:

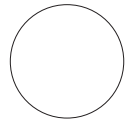

Blanco SM

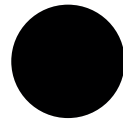

Negro SM



Como Ash 02



Como Ash 03

Poignée disponible dans les finitions :



Inox



Plata Mate



Negro Mate



Blanco Mate

Madeira



SYNCRON Anniversary Oak 01
Tirador integrado negro cepillado

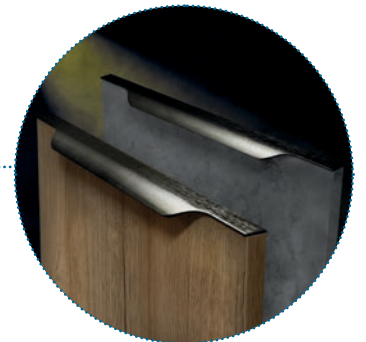

Puerta disponibles en toda la gama de colores del catálogo.

Tirador disponible en los acabados:



Inox Cepillado



Negro Cepillado

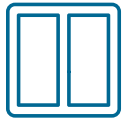

Elige el tirador integrado

Alpes



ZENIT Negro SM
Tirador integrado negro mate

Disponible en los colores:

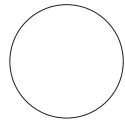

Blanco SM

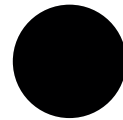

Negro SM



Como Ash 02



Como Ash 03

Tirador disponible en los acabados:



Inox



Plata Mate



Blanco Mate



Negro Mate

Gomera

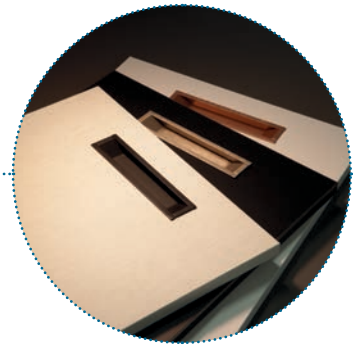

ZENIT Negro SM
Tirador integrado inox

Puerta disponibles en toda la gama de colores del catálogo.

Tirador disponible en los acabados:



Inox



Plata Mate



Cobre



Negro Mate

Lanzarote

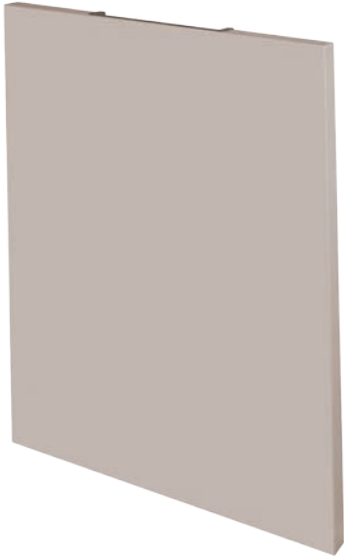

ZENIT Cashmere MD
Tirador integrado inox

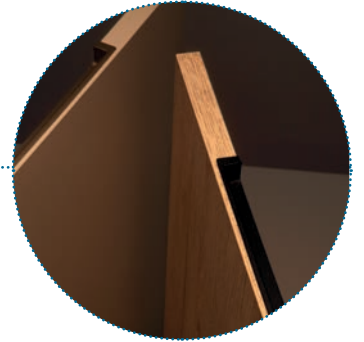

Puerta disponibles en toda la gama de colores del catálogo.

Tirador disponible en los acabados:



Inox



Negro Mate

Hierro



SYNCRON Osiris Plata FE
Tirador integrado plata mate



Puerta disponibles en toda la gama de colores del catálogo.

Tirador disponible en el acabado:



Plata Mate



Elige el tirador

Disponemos de una amplia gama de tiradores de todo tipo de estilos para combinar a la perfección en nuestras distintas superficies.

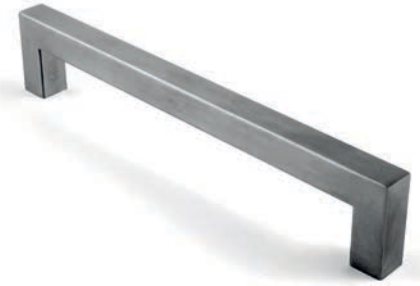

T05 Niquel Satinado



T09 Cromo Mate



T30 Inox



T42 Plata Vieja



T58 Plata Vieja



T59 Hierro Viejo



T60 Hierro Viejo



T61 Plata Vieja



T62 Hierro Viejo



T64 Champagne



T64 Grafito



T64 Cobre



T64 Chocolate

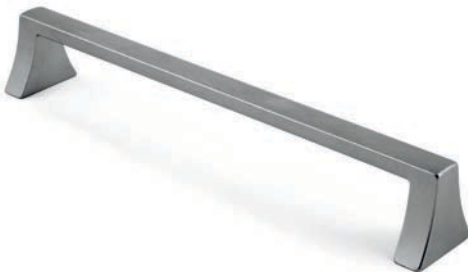

T65 Champagne



T65 Grafito



T68 Niquel Satinado



T66 Champagne

* Para ver la colección completa consulta el catálogo de herrajes en tu Alvic Center.



Elige la encimera

R3-SUPRA

“La versatilidad del laminado se potencia con el diseño”

Laminado con aplicación en mobiliario de cocina para planos de trabajo.

Las colecciones de mármoles, granitos, piedras, cementos, óxidos y maderas, combinan a la perfección con el resto de gamas y se adaptan a cualquier estilo ya sea clásico, rústico o moderno.



EP-002-SF
Blanco Soft



EP-023-MT
Lunar Claro

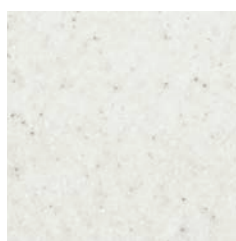

EP-050-MT
Mármol Micado

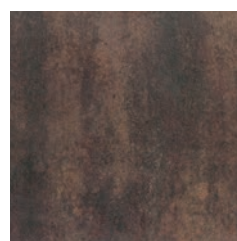

EP-086-IS
Fresko 51301



EP-087-IS
Fresko 51300

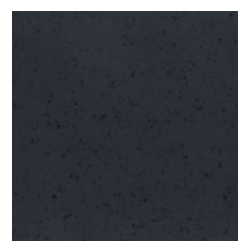

EP-090-PI
Piedra Carbón

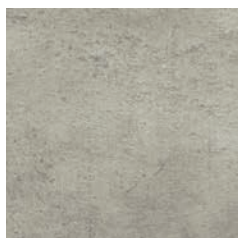

EP-091-IS
Cemento Natural



EP-031-BR
Granito Clásico



EP-092-IS
Cemento Oscuro

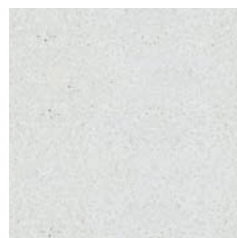

EP-112-GLS
Snow Terraz Blanco

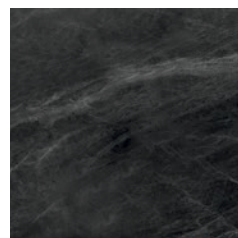

EP-116-BR
Mármol Markina BR



EP-120-AET
Mármol Maya Blanco



EP-124-OP
Roble Sonoma Nat

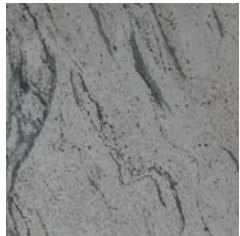

EP-138-PI
Piedra Tripura

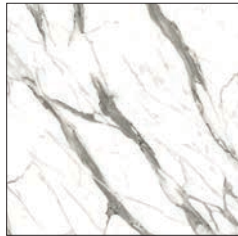

EP-140-SM
Mármol Versilia

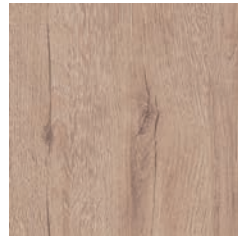

EP-141-NAT
Anniversary 02 Oak

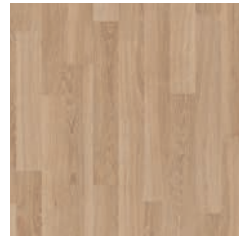

EP-142-SM
Roble Ibérico



EP-143-ST
Mármol Himeto



EP-144-YO
Mármol Nuvolato



EP-145-NAT
Madera Vintage

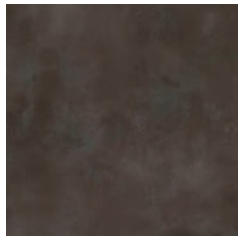

EP-146-PE
Porcelánico Tierra

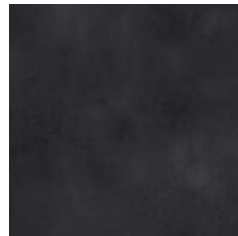

EP-147-PE
Porcelánico Carbón

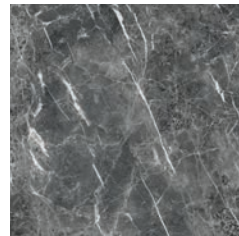

EP-148-PE
Mármol Tepeaca



EP-149-SN
Roca Plutónica



EP-150-YO
Mármol Travertino

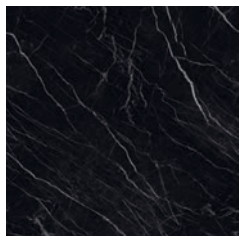

EP-151-ST
Mármol Marquina
Apomazado

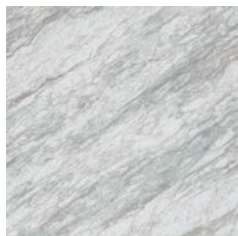

EP-152-YO
Mármol Ibiza



EP-153-AT
Pino Tintado

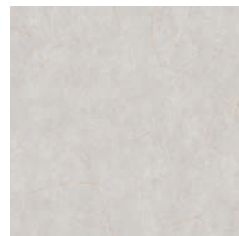

EP-154-YO
Porcelain 01 Gold



EP-155-YO
Porcelain 02 Gold

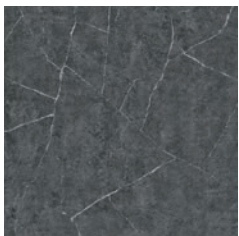

EP-156-YO
Porcelain 03 Silver

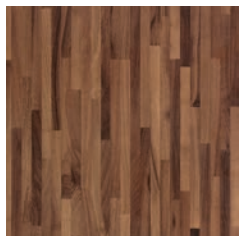

EP-096-OP
Nogal Parquet

También disponemos de otras marcas líderes del mercado como Silestone, Dekton, Neolith, etc.



Elige el módulo

Estética, ergonomía y versatilidad.

Nuestra colección de módulos incorpora características acordes a las necesidades de ergonomía y funcionalidad que los usuarios demandan.

Más de 5.000 referencias de módulos, altos, columnas y rinconeros para tu cocina. También tenemos la capacidad de fabricar muebles especiales para adaptarnos a tu proyecto.

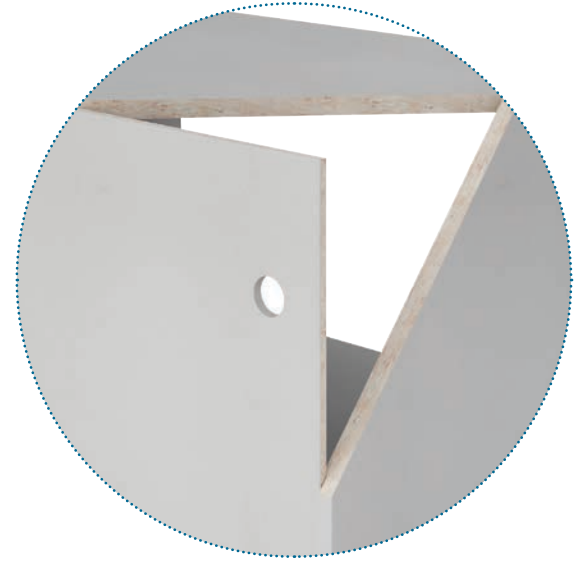

Sección trasera del casco

Características (Avantgarde y Classic)

- Tratamiento antibacteriano que garantiza unas condiciones óptimas de higiene en el uso diario del producto.
- Mecanizado de costado para bisagras y guías de cajón.
- Canteado en cola PUR.
- Espesor de la trasera: 8 mm.
- Los módulos se presentan en colores y diseños que permiten combinar el interior del mueble con las diferentes gamas Luxe, Zenit y Sincron.

Avantgarde



Microline



Roble Nórdico

Vista delantera

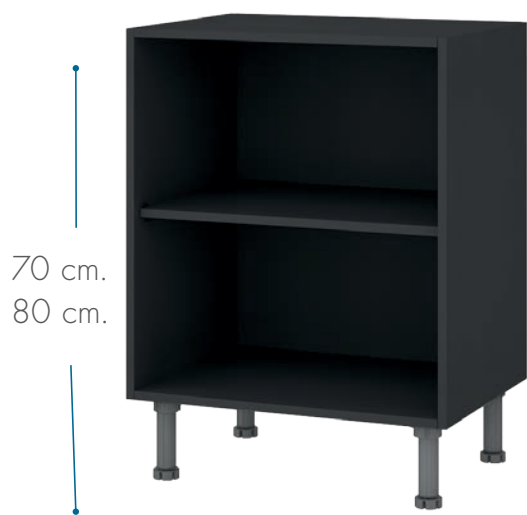

Vista trasera

Espacio para instalaciones

45 mm.

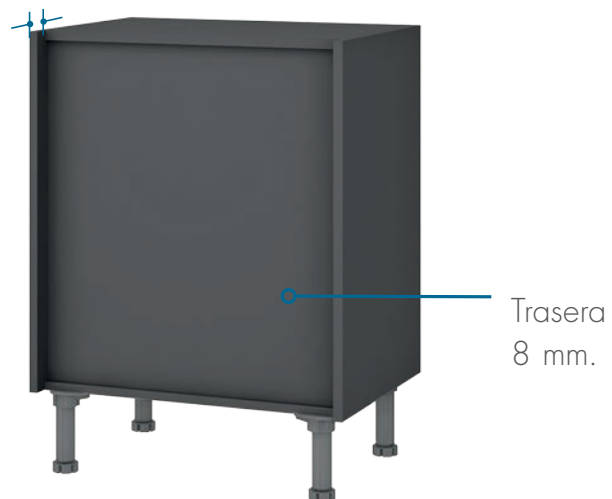

Classic



Blanco



Gris Plomo



Gris Aluminio

Interiorismos

Soluciones de almacenaje para aprovechar todo el espacio de tu cocina.



Encuentra fácilmente los alimentos y utensilios gracias a los cajones extraíbles.



Cajón rinconero para sacar el mayor partido a los puntos muertos.



Cuberteros para organizar a medida tu cocina.



Panera integrada.



El Cajón Evolution aúna una gran capacidad de almacenaje y elegancia con sus laterales de cristal y su sistema silencioso de apertura.

Comparativa de tecnologías

					
Fácil limpieza	•	•	•	•	•
 Larga durabilidad	•	•	•	•	•
Tratamiento antibacteria	•	•	-	•	•
 Alta resistencia al rayado	•	•	-	-	•
Alta resistencia a la abrasión	•	-	-	-	•
 Resistencia al manchado	•	•	•	•	•
Estabilidad del color	•	•	•	•	•
 Respetuosos con el medio ambiente	•	•	•	•	•
Tacto seda	-	-	•	-	-
 Anti-huella	-	-	•	-	-
Acabados naturales	-	-	-	•	•
 Alto brillo	•	•	-	-	-
Nivel de brillo superior 101 GU	•	-	-	-	-
 Efecto barrera	•	-	-	-	-
Calidad imagen reflejada	•	•	-	-	-

Certificado de Garantía

Este certificado de garantía del fabricante cubre al comprador de componentes para mobiliario fabricados por ALVIC ante cualquier posible defecto de fabricación de los mismos no apreciables durante su instalación, para los 5 años siguientes a la fecha de adquisición. ALVIC proveerá al distribuidor, sin cargo alguno, de:

- a) Los materiales reparados de los defectos originarios.
- b) Materiales nuevos de idénticas características, en los casos en que ALVIC haya optado por reemplazar el material defectuoso.

En los casos en los que, por causas no imputables a ALVIC alguna de las soluciones anteriores no fuera posible, éste ofrecerá una solución alternativa.

Exclusiones de la Garantía:

No quedan cubiertos por la garantía, los daños y fallos que tengan su origen en las siguientes circunstancias:

1. Fallos de instalación: se excluyen los defectos por: (I) mal procesamiento o montaje del mobiliario, (II) modificaciones del producto por procesos de corte y canteo o; (III) cualquier otra alteración no imputable a ALVIC que puedan sufrir los productos desde su salida de fabricación.
2. Hechos no atribuibles a ALVIC: filtraciones de agua, temperaturas demasiado altas, condiciones de humedad anormales, golpes, usos abusivos o no previstos, productos o métodos de limpieza no adecuados, cambio de tono debido a la luz solar, mal uso, negligencia, accidente, etc.
3. Daños por normal uso y evoluciones propias de los materiales (madera, laca, barnices, recubrimientos, etc.) que se produzcan con el paso del tiempo, así como las posibles diferencias de matiz aparecidas en los mismos.

Limitaciones de responsabilidad:

1. ALVIC no será responsable de los defectos y fallos en los componentes fabricados por ésta, que hayan sido adquiridos a un distribuidor no autorizado.
2. ALVIC no será responsable de ningún incumplimiento o demora en la aplicación de sus obligaciones de garantía, que pudieran ser originadas por terceros, causas de fuerza mayor o cualquier otro incidente imprevisto y ajeno a la voluntad de ALVIC.

*** Caducidad de los materiales, imposibilidad de suministro por parte de nuestros proveedores, cambios de actividad del distribuidor, etc.

3. ALVIC no atenderá a las posibles reclamaciones del distribuidor cuando éste no se encuentre al corriente de pago del producto sobre el que reclama la garantía.
4. El fabricante no estará sujeto a ninguna otra garantía que haya sido suscrita por el distribuidor o el instalador diferente de lo establecido en el presente Certificado.



Nota:

Sin perjuicio de lo anterior, esta garantía no limitará, ni menoscabará ningún derecho de garantía de los consumidores, según lo previsto en el Real Decreto Legislativo 1/2007, de 16 de noviembre, por el que se aprueba el texto refundido de la Ley General para la Defensa de los Consumidores y Usuarios.

Sostenibilidad

Desde ALVIC entendemos el papel que tenemos en la preservación de nuestro planeta y por ello seguimos una política que respeta el medio ambiente tanto en el empleo de materias primas certificadas como en los procesos industriales que se emplean en la elaboración de todos los productos y superficies.

ALVIC ha incorporado a sus procesos un sistema integrado de gestión (ISO 14001) cuyo principal objetivo es minimizar el impacto que, como consecuencia de nuestra actividad industrial, se pudiera provocar en el medio ambiente.



Nuestra política de aprovisionamiento tiene como prioridad aquellas materias primas certificadas en la Cadena de Custodia Forestal así como aquellas que provienen de procesos de reciclado y de reutilización de materiales. Así mismo, ALVIC cuenta con los certificados PEFC y FSC de cadena de custodia de recursos forestales, lo que garantiza un uso sostenible de los mismos.



Dónde encontrarnos

Más de 35 centros
en España y Francia.

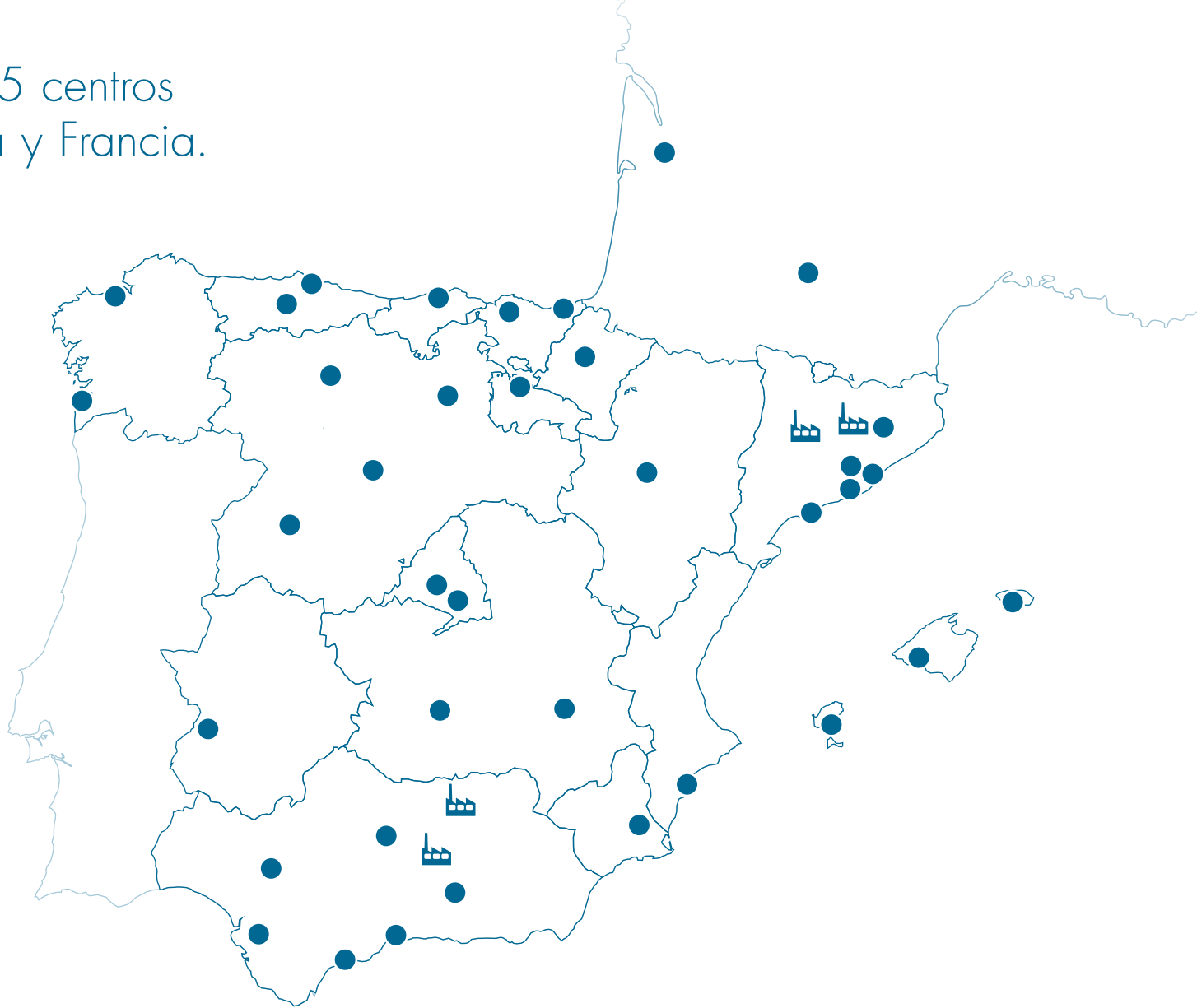

FÁBRICAS

ANDALUCÍA

Alcaudete
Calle Alcalde Juan Vallejo, 27, 29
23660 Alcaudete (Jaén)

La Carolina
Polígono Industrial El Martínón, s/n
23200 La Carolina (Jaén)

CATALUÑA

Solsona
Plaça de Sant Jordi, 78
25280 Solsona (Lleida)

Vic
Carrer del Mas de la Móra
08500 Vic (Barcelona)

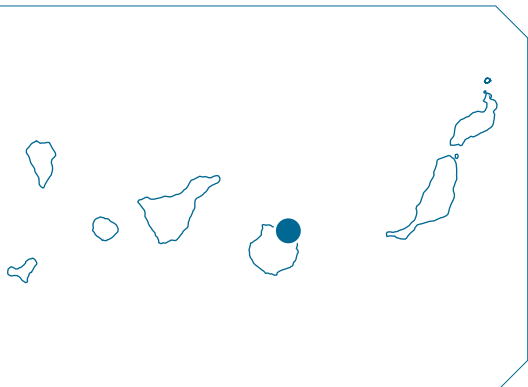



ALVIC CENTER

ANDALUCÍA

Córdoba
Estepona
Granada
Jerez
Málaga
Sevilla

ARAGÓN

Zaragoza

ASTURIAS

Gijón
Oviedo

BALEARES

Ibiza
Menorca
Palma de Mallorca

CANARIAS

Las Palmas

CANTABRIA

Santander

CASTILLA LA MANCHA

Albacete
Ciudad Real

CASTILLA Y LEÓN

Burgos
León
Salamanca
Valladolid

CATALUÑA

L'Hospitalet de Llobregat
Cornellà de Llobregat
Sabadell
Tarragona
Vic

COMUNIDAD VALENCIANA

Alicante

EXTREMADURA

Badajoz

GALICIA

A Coruña
Vigo

LA RIOJA

Logroño

MADRID

Alcobendas
Fuenlabrada

MURCIA

Murcia

NAVARRA

Pamplona

PAÍS VASCO

Bilbao
San Sebastián

FRANCIA

Burdeos
Toulouse

alviccenter.es

Bienvenido a tu lugar de trabajo

© **ALVIC 2021**

Queda terminantemente prohibida la reproducción parcial e integral a través de cualquier proceso mecánico o fotográfico sin el permiso de la sociedad.

ALV04458866E



alviccenter.es

